

## Operation Manual

MULTIMEDIA NAVIGATION RECEIVER

# AVIC-Z140BH AVIC-X940BT

### Notice to all users:

This software requires that the navigation system is properly connected to your vehicle's parking brake and depending on your vehicle, additional installation may be required. For more information, please contact your Authorized Pioneer Electronics retailer or call us at (800) 421-1404.

Be sure to read **Important Information for the User** first!

**Important Information for the User** includes the important information that you must understand before using this navigation system.

**HD Radio**<sup>®</sup>

This HD Radio receiver enables:

PSD

HD2/HD3

Digital Sound

iTunes<sup>®</sup> Tagging

Artist Experience



## Thank you for buying this Pioneer product.

Please read through these instructions so you will know how to operate your model properly. *After you have finished reading the instructions, keep this document in a safe place for future reference.*



### Important

The screens shown in the examples may differ from actual screens.  
Actual screens may be changed without notice for performance and function improvements.

## 01 Introduction

- Manual overview **10**
  - How to use this manual **10**
  - Conventions used in this manual **10**
  - Terms used in this manual **10**
- Notice regarding video viewing **11**
- Notice regarding DVD Video viewing **11**
- Notice regarding MP3 file usage **11**
- iPod compatibility **11**
- Map coverage **11**
- Protecting the LCD panel and screen **12**
- Notes on internal memory **12**
  - Before removing the vehicle battery **12**
  - Data subject to erasure **12**

## 02 Basic operation

- Checking part names and functions **14**
- Protecting your product from theft **16**
  - Removing the detachable faceplate **16**
  - Attaching the detachable faceplate **16**
- Adjusting the LCD panel angle **17**
- Inserting and ejecting a disc **17**
  - Inserting a disc (for AVIC Z140BH) **17**
  - Ejecting a disc (for AVIC Z140BH) **18**
  - Inserting a disc (for AVIC X940BT) **18**
  - Ejecting a disc (for AVIC X940BT) **18**
- Inserting and ejecting an SD memory card **18**
  - Inserting an SD memory card (for AVIC Z140BH) **19**

- Ejecting an SD memory card (for AVIC Z140BH) **19**
- Inserting an SD memory card (for AVIC X940BT) **20**
- Ejecting an SD memory card (for AVIC X940BT) **20**

- Plugging and unplugging a USB storage device **21**
  - Plugging in a USB storage device **22**
  - Unplugging a USB storage device **22**
- Connecting and disconnecting an iPod **22**
  - Connecting your iPod **22**
  - Disconnecting your iPod **22**
- Startup and termination **23**
  - On first time startup **23**
  - Regular startup **23**
    - A message about the map database **24**
- Demonstration images **24**

## 03 How to use the navigation menu screens

- Screen switching overview **26**
- What you can do on each menu **27**
  - Shortcut Menu **27**
    - Selecting the shortcut **27**
    - Removing a shortcut **28**
- Operating list screens (e.g. POI list) **28**
- Operating the on screen keyboard **28**

## 04 How to use the map

- How to read the map screen **29**
  - Enlarged map of the intersection **30**
  - Display during freeway driving **31**
- Types of the road stored in the map database **31**
- Operating the map screen **31**
  - Changing the scale of the map **31**
  - Switching the map orientation **32**
  - Scrolling the map to the position you want to see **32**

- Viewing information about a specified location **32**
- Using shortcut menus on the map **33**
- Switching the view mode **34**
- 05 Eco-friendly driving functions**
  - Checking the eco friendly driving status **35**
  - Displaying Eco Drive Level guidance **36**
  - Sudden start alert **36**
- 06 Searching for and selecting a location**
  - The basic flow of creating your route **37**
  - Searching for a location by address **38**
    - Searching for a city name first **38**
    - Finding the location by specifying the house number **39**
    - Searching by selected city history **40**
  - Setting up a route to your home **40**
  - Searching for Points of Interest (POI) **40**
    - Searching for POIs by preset categories **41**
    - Searching for a POI directly from the name of the facilities **41**
    - Searching for a nearby POI **41**
    - Searching for POIs around the destination **42**
    - Searching for POIs around the city **42**
  - Selecting destination from "Favorites" **43**
  - Searching for POIs by using the data on the SD memory card **43**
  - Selecting a location you searched for recently **44**
  - Searching for a location by coordinates **44**
- 07 After the location is decided**
  - Setting a route to your destination **45**
  - Displaying multiple routes **45**
- 08 Checking and modifying the current route**
  - Displaying the route overview **46**
  - Modifying the route calculation conditions **46**
    - Items that users can operate **46**
  - Checking the current itinerary **47**
  - Editing waypoints **48**
    - Adding a waypoint **48**
    - Deleting a waypoint **48**
    - Sorting waypoints **49**
  - Canceling the route guidance **49**
- 09 Registering and editing locations**
  - Storing favorite locations **50**
    - Registering a location by "Favorites" **50**
    - Registering a location by scroll mode **50**
  - Editing registered locations **50**
    - Editing the favorite location in the list **50**
    - Editing your home **51**
    - Sorting the favorite locations in the list **51**
    - Deleting a favorite location from the list **52**
  - Exporting and importing favorite locations **52**
    - Exporting favorite locations **52**
    - Importing favorite locations **52**
  - Deleting the destination history from the list **53**
- 10 Using traffic information**
  - Checking all traffic information **54**
  - Checking traffic information on the route **55**
  - How to read traffic information on the map **55**

- Viewing the traffic flow **55**
- Setting an alternative route to avoid traffic congestion **56**
  - Checking for traffic congestion automatically **57**
  - Checking traffic information manually **57**
- Selecting traffic information to display **58**
- Selecting preferred RDS TMC service provider manually **58**

## **11 Registering and connecting a Bluetooth device**

- Preparing communication devices **59**
- Registering your Bluetooth devices **59**
  - Searching for nearby Bluetooth devices **59**
  - Pairing from your Bluetooth devices **60**
  - Searching for a specified Bluetooth device **61**
  - Deleting a registered device **62**
- Connecting a registered Bluetooth device manually **62**
  - Setting for priority connecting **63**

## **12 Using hands-free phoning**

- Displaying the phone menu **64**
- Making a phone call **64**
  - Direct dialing **64**
  - Making a call home easily **65**
  - Calling a number in the phone book **65**
  - Dialing from the history **66**
  - Dialing a favorite location **66**
  - Dialing a facility's phone number **66**
  - Dialing from the map **67**
- Receiving a phone call **67**
  - Answering an incoming call **67**
- Transferring the phone book **68**

- Changing the order of names in the phone book **69**
- Deleting registered contacts **69**
- Changing the phone settings **69**
  - Editing the device name **69**
  - Editing the password **70**
  - Stopping Bluetooth wave transmission **70**
  - Echo canceling and noise reduction **70**
  - Answering a call automatically **70**
  - Setting the automatic rejection function **71**
  - Clearing memory **71**
  - Updating the Bluetooth wireless technology software **72**
- Notes for hands free phoning **72**

## **13 Basic operations of the AV source**

- Displaying the AV operation screen **74**
  - Selecting a source **74**
- Operating list screens (e.g. iPod list screen) **74**
  - Switching between the AV operation screen and the list screen **74**
  - Selecting an item **75**
  - Returning to the previous display **75**

## **14 Using the radio (FM)**

- Starting procedure **76**
- Reading the screen **76**
- Using the touch panel keys **77**
  - Storing and recalling broadcast frequencies **77**
- Operating by hardware buttons **78**
- Using advanced functions **78**
  - Storing the strongest broadcast frequencies **78**
  - Tuning in strong signals **78**

## 15 Using the radio (AM)

- Starting procedure **80**
- Reading the screen **80**
- Using the touch panel keys **81**
  - Storing and recalling broadcast frequencies **81**
- Operating by hardware buttons **82**
- Using advanced functions **82**
  - Storing the strongest broadcast frequencies **82**
  - Tuning in strong signals **82**

## 16 HD Radio™ reception

- HD Radio broadcasting **84**
- Starting procedure **84**
- Reading the screen **85**
- Using the touch panel keys **86**
  - Storing and recalling broadcast frequencies **87**
- Operating by hardware buttons **87**
- Switching the display **87**
  - Scrolling the detailed information **88**
- Storing song information to an iPod (iTunes Tagging) **88**
- Using advanced functions **88**
  - Storing the strongest broadcast frequencies **89**
  - Switching the seek mode **89**
  - Tuning in strong signals **89**
  - Switching the reception mode **89**

## 17 Playing audio CDs

- Starting procedure **91**
- Reading the screen **91**
- Using the touch panel keys **92**
- Operating by hardware buttons **93**
- Using advanced functions **93**

## 18 Playing music files on ROM

- Starting procedure **94**

- Reading the screen **94**
- Using the touch panel keys **96**
- Operating by hardware buttons **97**
- Using advanced functions **97**

## 19 Playing a DVD-Video

- Starting procedure **99**
- Reading the screen **99**
- Using the touch panel keys **100**
  - Resuming playback (Bookmark) **101**
  - Searching for a specific scene and starting playback from a specified time **102**
  - Direct number search **102**
  - Operating the DVD menu **102**
  - Using DVD menu by touch panel keys **102**
  - Frame by frame playback **103**
  - Slow motion playback **103**
- Operating by hardware buttons **103**
- Using advanced functions **103**

## 20 Playing a DivX video

- Starting procedure **105**
- Reading the screen **105**
- Using the touch panel keys **106**
  - Frame by frame playback **107**
  - Slow motion playback **107**
  - Starting playback from a specified time **108**
- Operating by hardware buttons **108**
- Using advanced functions **108**

## 21 DVD-Video or DivX setup

- Displaying DVD/DivX® Setup menu **109**
- Setting the top priority languages **109**
- Setting the angle icon display **109**
- Setting the aspect ratio **110**
- Setting the parental lock **110**

- Setting the code number and level **110**
- Setting the auto play **111**
- Setting the subtitle file for DivX **111**
- Language code chart for DVDs **112**
- 22 Playing music files (from USB or SD)**
  - Starting procedure **113**
  - Reading the screen **113**
  - Using the touch panel keys (Music) **115**
  - Operating by hardware buttons **116**
  - Using advanced functions **116**
- 23 Playing video files (from USB or SD)**
  - Starting procedure **117**
  - Reading the screen **117**
  - Using the touch panel keys (Video) **118**
    - Searching for a specific scene and starting playback from a specified time **119**
  - Operating by hardware buttons **119**
  - Using advanced functions **119**
- 24 Using an iPod (iPod)**
  - Starting procedure **120**
  - Reading the screen **120**
  - Using the touch panel keys **122**
  - Operating by hardware buttons **124**
  - Starting the video playback **124**
  - Narrowing down a song or video with the list **124**
  - Operating an application for iPhone from the navigation system **126**
    - Starting procedure **126**
    - Using the touch panel keys **126**
    - Using the keyboard **127**
    - When using an application not compatible with Advanced App Mode **128**
  - Operating the functions from your iPod **128**
    - Starting procedure **128**
    - Using the touch panel keys **128**
  - Playing MusicSphere **129**
    - Starting procedure **129**
    - Reading the screen **129**
    - Using the touch panel keys **129**
  - Using advanced functions **129**
- 25 Using smartphone applications**
  - Information for the smartphone compatibility **131**
  - Starting procedure **131**
    - For Android device and BlackBerry device users **132**
    - For iPhone users **132**
  - Using Pandora® internet radio **133**
    - Reading the screen **133**
    - Using the touch panel keys **134**
    - Operating by hardware buttons **135**
  - Using Aha Radio **135**
    - Reading the screen **135**
    - Using the touch panel keys **136**
    - Functions coupled with Aha Radio and the navigation system **137**
- 26 Using the Bluetooth audio player**
  - Starting procedure **138**
  - Reading the screen **138**
  - Using the touch panel keys **140**
  - Operating by hardware buttons **140**
  - Using advanced functions **141**
- 27 Using the XM tuner**
  - Starting procedure **142**
  - Reading the screen **142**
  - Using the touch panel keys **144**
    - Selecting an XM channel directly **145**
    - Displaying the Radio ID **145**
    - Storing and recalling broadcast stations **146**

- Selecting a channel from the list **146**
- Using "MyMix" function **146**
- Operating by hardware buttons **147**
- Using advanced functions **147**
  - Setting the memorized songs **147**
- 28 Using the SIRIUS tuner**
  - Starting procedure **148**
  - Reading the screen **148**
  - Using the touch panel keys **149**
    - Selecting a SIRIUS channel directly **150**
    - Display the Radio ID **150**
    - Storing and recalling broadcast stations **150**
    - Using the song alert function **151**
    - Using the "Instant Replay" function **151**
  - Operating by hardware buttons **152**
  - Using advanced functions **152**
    - Setting the memorized songs **152**
    - Using the Game Alert function **152**
    - Displaying Game Information **153**
- 29 Using AV input**
  - Reading the screen **154**
  - Using AV1 **154**
  - Using AV2 **154**
  - Using the touch panel keys **154**
- 30 Using the external unit (EXT1, EXT2)**
  - Starting procedure **155**
  - Reading the screen **155**
  - Using the touch panel keys **156**
- 31 Customizing preferences**
  - Displaying the screen for navigation settings **157**
  - Checking the connections of leads **157**
  - Checking sensor learning status and driving status **158**
    - Clearing status **158**
  - Using the fuel consumption function **159**
    - Inputting the fuel consumption information for calculating the fuel cost **159**
    - Calculating the fuel consumption **159**
    - Exporting the data of fuel cost information **160**
  - Recording your travel history **161**
  - Using the demonstration guidance **161**
  - Registering your home **162**
  - Correcting the current location **162**
  - Changing the eco function setting **162**
    - Clearing the fuel consumption information **163**
  - Displaying the screen for map settings **163**
  - Setting the auto zoom display **164**
  - Setting the detailed city map **164**
  - Setting the barrier graphic for city map **164**
  - Displaying the traffic notification icon **165**
  - Displaying the Bluetooth connection icon **165**
  - Setting the current street name display **165**
  - Setting the display of icons of favorite locations **166**
  - Displaying the 3D landmarks **166**
  - Displaying maneuvers **166**
  - Displaying the fuel consumption information **167**
  - Displaying POI on the map **167**
    - Displaying preinstalled POIs on the map **167**
    - Displaying the customized POIs **168**
  - Changing the view mode **168**
  - Setting the map color change between day and night **168**
  - Changing the road color **169**

- Changing the setting of navigation interruption screen **169**
  - Selecting the “Quick Access” menu **169**
  - Displaying the screen for system settings **170**
    - Customizing the regional settings **170**
    - Setting the Volume for Guidance and Phone **172**
    - Changing the preinstalled splash screen **173**
    - Changing to the splash screen stored in the SD memory card **173**
    - Setting for rear view camera **174**
    - Adjusting the response positions of the touch panel (touch panel calibration) **174**
    - Setting the illumination color **175**
    - Checking the version information **175**
  - Selecting the video for rear display **176**
  - Adjusting the picture **176**
  - Displaying the screen for AV system settings **177**
    - Setting video input 1 (AV1) **177**
    - Setting video input 2 (AV2) **178**
    - Changing the wide screen mode **178**
    - Setting the rear output **179**
    - Switching the muting/attenuation timing **179**
    - Switching the muting/attenuation level **179**
    - Acquiring/Cataloging iPod music information **180**
    - Displaying your DivX VOD registration code **181**
    - Displaying your DivX VOD deregistration code **181**
    - Selecting the smartphone connection method **181**
  - Displaying the screen for AV sound settings **181**
    - Using balance adjustment **182**
    - Using the equalizer **182**
    - Adjusting the equalizer curve automatically (Auto EQ) **184**
    - Using sonic center control **186**
    - Adjusting loudness **186**
    - Using subwoofer output **187**
    - Using the high pass filter **187**
    - Adjusting source levels **187**
    - Enhancing bass (Bass Booster) **188**
  - Replicating the settings **188**
  - Turning off the screen **188**
- 32** **Operating your navigation system with voice**
- To Ensure Safe Driving **189**
  - Basics of the voice operation **189**
    - Flow of the voice operation **189**
    - Starting the voice operation **189**
    - How to use the voice operation **190**
  - Available basic voice commands **191**
    - Basic commands **191**
    - Voice operation for the iPod **191**
    - Voice operation for AV source (other than iPod) **192**
    - Voice commands related to hands free phoning **193**
  - Tips for the voice operation **194**
- 33** **Other functions**
- Setting the anti theft function **195**
    - Setting the password **195**
    - Entering the password **195**
    - Deleting the password **195**
    - Forgotten password **195**
  - Returning the navigation system to the default or factory settings **196**
    - Restoring the default setting **196**



Returning the navigation system to the initial state **196**

Setting items to be deleted **197**

## ● Appendix

Troubleshooting **199**

Messages for navigation functions **204**

Messages for audio functions **206**

Positioning technology **208**

Positioning by GPS **208**

Positioning by dead reckoning **208**

How do GPS and dead reckoning work together? **208**

Handling large errors **209**

When positioning by GPS is impossible **209**

Conditions likely to cause noticeable positioning errors **210**

Route setting information **212**

Route search specifications **212**

Handling and care of discs **212**

Built in drive and care **213**

Ambient conditions for playing a disc **213**

Playable discs **213**

DVD Video and CD **213**

AVCHD recorded discs **214**

Playing DualDisc **214**

Dolby Digital **214**

Detailed information for playable media **214**

Compatibility **214**

Media compatibility chart **217**

Bluetooth **221**

About the SAT RADIO READY Logo **221**

HD Radio™ Technology **221**

SD and SDHC logo **222**

WMA/WMV **222**

DivX **222**

AAC **222**

Android™ **222**

BlackBerry® **223**

Detailed information regarding connected

iPod devices **223**

iPod and iPhone **223**

iTunes **223**

Using app based connected content **223**

Pandora® internet **224**

Aha Radio **224**

Using the LCD screen correctly **224**

Handling the LCD screen **224**

Liquid crystal display (LCD) screen **224**

Maintaining the LCD screen **224**

LED (light emitting diode)

backlight **225**

Display information **226**

Destination Menu **226**

Phone Menu **226**

Settings Menu **227**

Navi Settings menu **227**

System Settings menu **228**

Map Settings menu **228**

Bluetooth Settings menu **229**

AV System Settings menu **229**

AV Sound Settings menu **230**

Glossary **231**

Specifications **234**

## Manual overview

Before using this product, be sure to read **Important Information for the User** (a separate manual) which contains warnings, cautions, and other important information that you should note.

The screen examples shown in this manual are the ones for AVIC Z140BH. If you use a different model, the screens that appear may differ from the examples in the manual.

## How to use this manual

### Finding the operation procedure for what you want to do

When you have decided what you want to do, you can find the page you need from the *Contents*.

### Finding the operation procedure from a menu name

If you want to check the meaning of an item displayed on the screen, you will find the necessary page from the *Display information* at the end of the manual.

### Glossary

Use the glossary to find the meanings of terms.

## Conventions used in this manual

Before moving on, take a few minutes to read the following information about the conventions used in this manual. Familiarity with these conventions will help you greatly as you learn how to use your new equipment.

- Buttons on your navigation system are described in **ALL CAPITAL, BOLD** lettering: e.g.) **HOME** button, **MODE** button.
- Menu items, screen titles, and functional components are described in **bold** with double quotation marks “ ”: e.g.)

“**Destination Menu**” screen or “**AV Source**” screen

- Touch panel keys that are available on the screen are described in **bold** in brackets []: e.g.) [**Destination**], [**Settings**].
- Extra information, alternatives and other notes are presented in the following for mat: e.g.)
  - ☐ If the home location has not been stored yet, set the location first.
- Functions of other keys on the same screen are indicated with ■ at the beginning of the description: e.g.)
  - If you touch [**OK**], the entry is deleted.
- References are indicated like this: e.g.)
  - ➔ For details of the operations, refer to *Screen switching overview* on page 26.

## Terms used in this manual

### “Front display” and “Rear display”

In this manual, the screen that is attached to the body of this navigation unit will be referred to as the “Front display”. Any additional screen that is commercially available and can be connected to this navigation unit will be referred to as the “Rear display”.

### “Video image”

“Video image” in this manual indicates moving images of DVD Video, DivX®, iPod, and any equipment that is connected to this system with an RCA cable, such as general purpose AV equipment.

### “External storage device (USB, SD)”

The SD memory card, SDHC memory card, microSD card, microSDHC card and USB memory device are collectively referred to as the “external storage device (USB, SD)”. If it indicates the USB memory only, it is referred to as the “USB storage device”.

## Introduction

### “SD memory card”

The SD memory card, SDHC memory card, microSD card and microSDHC card are collectively referred to as the “SD memory card”.

### Notice regarding video viewing

Remember that use of this system for commercial or public viewing purposes may constitute an infringement on the author’s rights as protected by the Copyright Law.

### Notice regarding DVD-Video viewing

This item incorporates copy protection technology that is protected by U.S. patents and other intellectual property rights of Rovi Corporation. Reverse engineering and disassembly are prohibited.

### Notice regarding MP3 file usage

Supply of this navigation system conveys only a license for private, non commercial use and does not convey a license nor imply any right to use this product in any commercial (i.e. revenue generating), real time broadcasting (terrestrial, satellite, cable and/or any other media), broadcasting/streaming via internet, intranets and/or other networks or in other electronic content distribution systems, such as pay audio or audio on demand applications. An independent license for such use is required. For details, please visit <http://www.mp3licensing.com>.

### iPod compatibility

This product supports only the following iPod models and iPod software versions. Others may not work correctly.

- iPod touch (4th generation): iOS 5.0
  - iPod touch (3rd generation): iOS 5.0
  - iPod touch (2nd generation): iOS 4.2.1
  - iPod touch (1st generation): iOS 3.1.3
  - iPod classic 120GB: Ver. 2.0.1
  - iPod classic 160GB (2009): Ver. 2.0.4
  - iPod classic 80GB: Ver. 1.1.2
  - iPod classic 160GB (2007): Ver. 1.1.2
  - iPod nano (6th generation): Ver. 1.1
  - iPod nano (5th generation): Ver. 1.0.2
  - iPod nano (4th generation): Ver. 1.0.4
  - iPod nano (3rd generation): Ver. 1.1.3
  - iPhone 4S: iOS 5.0
  - iPhone 4: iOS 5.0
  - iPhone 3GS: iOS 5.0
  - iPhone 3G: iOS 4.2.1
  - iPhone: iOS 3.1.3
- In this manual, iPod and iPhone will be referred to as iPod.
- When you use this navigation system with a Pioneer USB interface cable for iPod (CD LU51V) (sold separately), you can control an iPod compatible with this navigation system.
- Operation methods may vary depending on the iPod models and the software version of iPod.
- Depending on the software version of the iPod, it may not be compatible with this equipment.  
For details about iPod compatibility with this navigation system, refer to the information on our website.

### Map coverage

For details about the map coverage of this navigation system, refer to the information on our website.

## Protecting the LCD panel and screen

- ❑ Do not allow direct sunlight to fall on the LCD screen when this product is not being used. Extended exposure to direct sunlight can result in LCD screen malfunction due to the resulting high temperatures.
- ❑ When using a cellular phone, keep the antenna of the cellular phone away from the LCD screen to prevent disruption of the video in the form of spots, colored stripes, etc.
- ❑ To protect the LCD screen from damage, be sure to touch the touch panel keys with your finger only and gently touch the screen. 

## Notes on internal memory

### Before removing the vehicle battery

If the battery is disconnected or discharged, the memory will be erased and must be reprogrammed.

- ❑ Some data remains. Be sure to read *Setting items to be deleted* first.
  - ➔ For details, refer to *Setting items to be deleted* on page 197.

### Data subject to erasure

The information is erased by disconnecting the yellow lead from the battery (or removing the battery itself).

- ❑ Some data remains. Be sure to read *Setting items to be deleted* first.
  - ➔ For details, refer to *Setting items to be deleted* on page 197. 

# Introduction

## Checking part names and functions

This chapter gives information about the names of the parts and the main features using the buttons.

### AVIC-Z140BH (with the LCD panel closed)

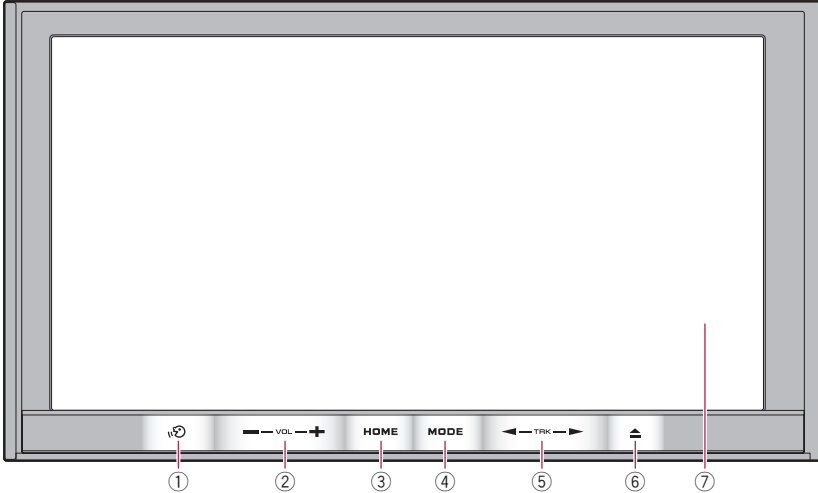

### AVIC-Z140BH (with the LCD panel open)

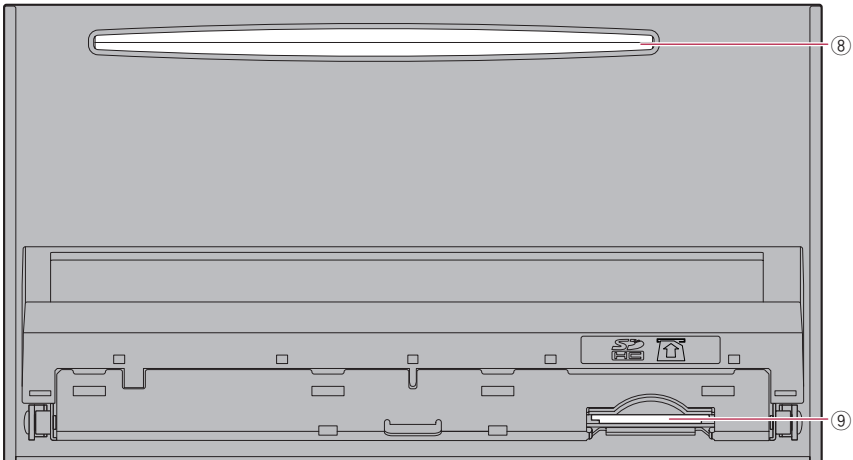

# Basic operation

## AVIC-X940BT

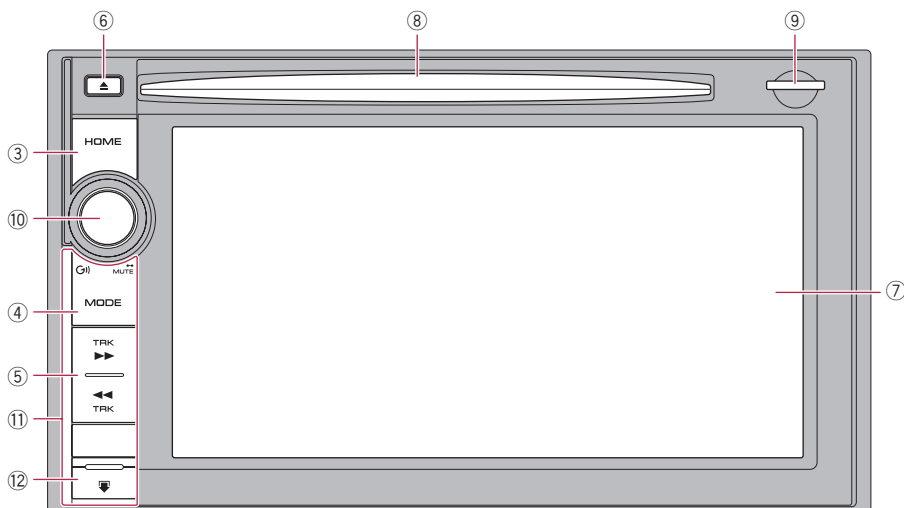

- ① **v button**
  - Press the v button to activate voice operations.
    - ➡ For details, refer to Chapter 32.
  - Press and hold the v button to switch the AV source to mute. To cancel the muting, press and hold it again.
- ② **VOL (+/-) button**

Press to adjust the AV (Audio and Video) source volume.
- ③ **HOME button**
  - Press the **HOME** button to display the "Top Menu" screen.
  - Press to switch between the Classic Menu and the Shortcut Menu while the "Top Menu" is displayed.
    - ➡ For details, refer to *What you can do on each menu* on page 27.
  - Press and hold to turn off the screen display.
- ④ **MODE button**
  - Press to switch between the map screen and the AV operation screen.
- ⑤ **TRK button**

Press to perform manual seek tuning, fast forward, reverse and track search controls.
- ⑥ **▲ button**
- ⑦ **LCD screen**
- ⑧ **Disc-loading slot**

Insert a disc to play.

  - ➡ For details, refer to *Inserting and ejecting a disc* on page 17.
- ⑨ **SD card slot**
  - ➡ For details, refer to *Inserting and ejecting an SD memory card* on page 18.
- ⑩ **Multi-control (Volume knob/G)/MUTE)**
  - Rotate to adjust the AV (Audio and Video) source volume.
- Press to display the map screen while the navigation function screen is displayed.
- Press and hold to display the "Picture Adjustment" screen.
  - ➡ For details, refer to *Adjusting the picture* on page 176.

- Press the center of Multi control to hear the route guidance.
- Press and hold the center of Multi control to mute the AV (Audio and Video) source. To cancel the muting, press and hold it again.

### ⑪ Detachable faceplate

#### ⑫ button

Press to remove the detachable faceplate from the navigation system.

- ➔ For details, refer to *Removing the detachable faceplate* on this page. 

## Protecting your product from theft

-  This function is available for AVIC X940BT only.

The detachable faceplate can be detached from the navigation system to discourage theft, as described below.

### CAUTION

- Do not expose the detachable faceplate to excessive shock or disassemble it.
- Never grip the buttons tightly or use force when removing or attaching.
- Keep the detachable faceplate out of reach of small children to prevent them from putting it in their mouths.
- After removing the detachable faceplate, keep it in a safe place so it is not scratched or damaged.
- Keep the detachable faceplate out of direct sunlight and high temperatures.
- When removing or attaching the detachable faceplate, do so after turning the ignition switch off (ACC OFF).

## Removing the detachable faceplate

-  The navigation system cannot be operated while the detachable faceplate is removed from the navigation system.

### 1 Press and hold the button, and slide it down.

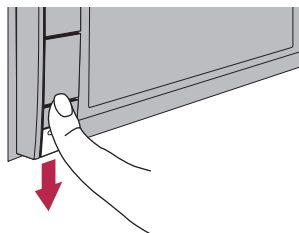

When you release your finger, the bottom of the detachable faceplate separates slightly from the navigation system.

### 2 Gently grip the bottom of the detachable faceplate and slowly pull it outward.

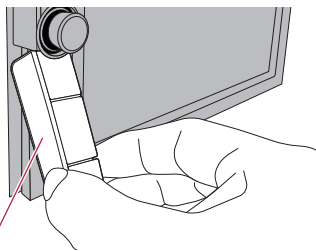

Detachable faceplate

## Attaching the detachable faceplate

### 1 Slide the detachable faceplate all the way into the navigation system.

Make sure the detachable faceplate is securely connected to the mounting hooks of the navigation system.



## Basic operation

### 2 Push the lower part of the detachable faceplate until you hear a click.

If you fail to successfully attach the detachable faceplate to the navigation system, try again but be careful not to force it as the panel could be damaged. 

### Adjusting the LCD panel angle

- This function is available for AVIC Z140BH only.

#### WARNING

Keep hands and fingers clear of the unit when opening, closing, or adjusting the LCD panel. Be especially cautious of children's hands and fingers.

#### CAUTION

Do not open or close the LCD panel by force. This may cause malfunction.

#### 1 Press the button.

The "Monitor Setup" screen appears.

#### 2 Touch or to adjust the angle.



#### 3 Touch .

- The adjusted angle of the LCD panel will be memorized and the LCD panel will automatically return to that angle the next time the LCD panel is opened or closed. 

### Inserting and ejecting a disc

#### Inserting a disc (for AVIC-Z140BH)

#### WARNING

- Keep hands and fingers clear of the unit when opening, closing, or adjusting the LCD panel. Be especially cautious of children's hands and fingers.
- Do not use with the LCD panel left open. If LCD panel is left open, it may result in injury in the event of an accident.

#### CAUTION

- Do not open or close the LCD panel by force. This may cause malfunction.
- Do not operate this navigation system until the LCD panel completely opens or closes. If this navigation system is operated while the LCD panel is opening or closing, the LCD panel may stop at that angle for safety.
- Do not place a glass or a can on the open LCD panel. Doing so may break this navigation system.
- Do not insert anything other than a disc into the disc loading slot.

#### 1 Press the button.

The "Monitor Setup" screen appears.

#### 2 Touch [Open].



The LCD panel opens, and the disc loading slot appears.

### 3 Insert a disc into the disc-loading slot.

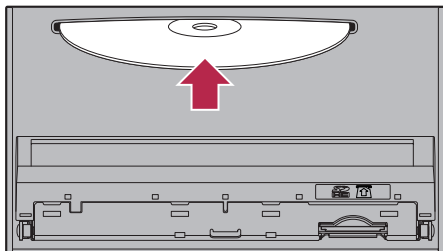

The disc is loaded, and the LCD panel closes.

### Ejecting a disc (for AVIC-Z140BH)

#### 1 Press the **▲** button.

The "Monitor Setup" screen appears.

#### 2 Touch [Disc Eject].

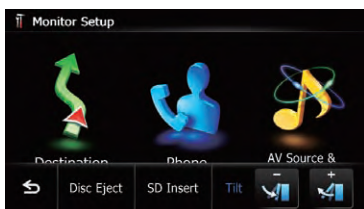

The LCD panel opens, and the disc is ejected.

### 3 Remove the disc, and press the **▲** button.

The LCD panel closes.

### Inserting a disc (for AVIC-X940BT)

#### **!** CAUTION

Do not insert anything other than a disc into the disc loading slot.

### ● Insert a disc into the disc-loading slot.

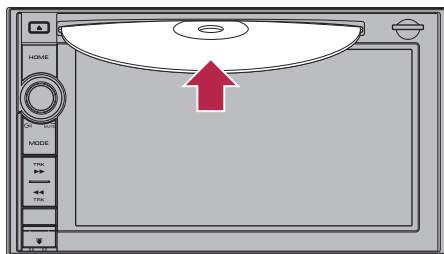

### Ejecting a disc (for AVIC-X940BT)

#### 1 Press the **▲** button.

The touch panel keys for ejecting the media appear.

#### 2 Touch [Disc Eject].



The disc is ejected. 

### Inserting and ejecting an SD memory card

#### **!** CAUTION

- Ejecting an SD memory card during data transfer can damage the SD memory card. Be sure to eject the SD memory card by the procedure described in this manual.
- If data loss or corruption occurs on the storage device for any reason, it is usually not possible to recover the data. Pioneer accepts no liability for damages, costs or expenses arising from data loss or corruption.
- Do not insert anything other than SD memory cards.

## Basic operation

- ❑ This system is not compatible with Multi Media Card (MMC).
- ❑ Compatibility with all SD memory cards is not guaranteed.
- ❑ This unit may not achieve optimum performance with some SD memory cards.

### Inserting an SD memory card (for AVIC-Z140BH)

#### ⚠ CAUTION

- Do not press the ▲ button when an SD memory card is not fully inserted. Doing so may damage the card.
- Do not press the ▲ button before an SD memory card has been completely removed. Doing so may damage the card.

#### 1 Press the ▲ button.

The “Monitor Setup” screen appears.

#### 2 Touch [SD Insert].



The LCD panel opens, and the SD card slot appears.

#### 3 Insert an SD memory card into the SD card slot.

Insert it with the label surface facing to the up side and press the card until it clicks and completely locks.

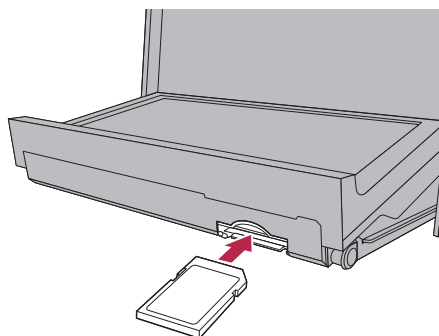

#### 4 Press the ▲ button.

The LCD panel closes.

- ❑ If data related to map data, such as customized POI data, is stored on the SD memory card, the navigation system restarts.

### Ejecting an SD memory card (for AVIC-Z140BH)

#### 1 Press the ▲ button.

The “Monitor Setup” screen appears.

#### 2 Touch [Eject SD].

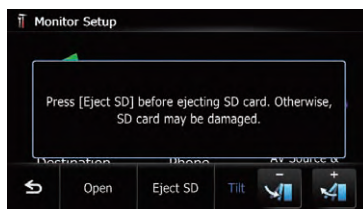

The LCD panel opens.

#### 3 Press the middle of the SD memory card gently until it clicks.

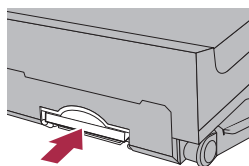

#### 4 Pull the SD memory card out straight.

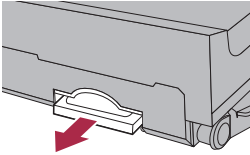

#### 5 Press the **▲** button.

The LCD panel closes.

- When you eject the SD memory card by touching [**Eject SD**], the model information that you are using will be automatically stored into the SD memory card. The utility program AVIC FEEDS will use this information to recognize the model that you use.

### When the data related to map data is stored

□ This description is for AVIC Z140BH. If data related to map data, such as customized POI data, is stored on the SD memory card, operating procedures are slightly different.

#### 1 Press the **▲** button and then touch [**Eject SD**].

#### 2 Touch [**Yes**].

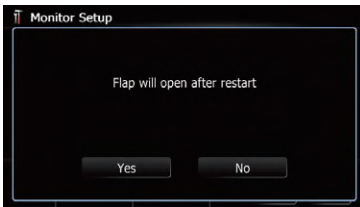

The navigation system restarts, and then the LCD panel opens.

#### 3 Eject the SD memory card.

#### 4 Press the **▲** button.

The LCD panel closes.

### Inserting an SD memory card (for AVIC-X940BT)

#### ● Insert an SD memory card into the SD card slot.

Insert the SD memory card with the terminal contacts facing down, and press the card until it clicks and locks completely.

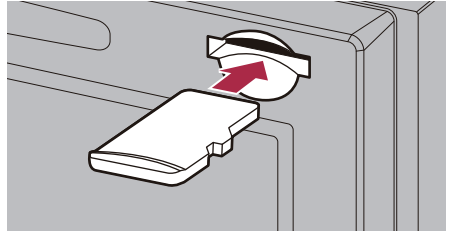

- If data related to map data, such as customized POI data, is stored on the SD memory card, the navigation system restarts.

### Ejecting an SD memory card (for AVIC-X940BT)

#### 1 Press the **▲** button.

The touch panel keys for ejecting the media appear.

#### 2 Touch [**Eject SD**].

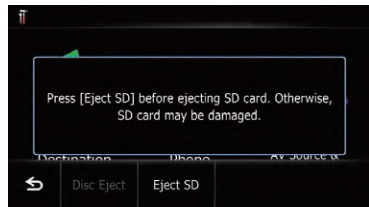

A message prompting you to remove the SD memory card appears.

## Basic operation

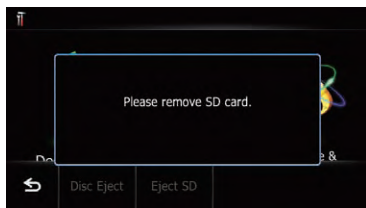

- 3 Press the middle of the SD memory card gently until it clicks.



- 4 Pull the SD memory card out straight.



### When the data related to map data is stored

☐ This description is for AVIC X940BT. If data related to map data, such as customized POI data, is stored on the SD memory card, operating procedures are slightly different.

- 1 Press the **▲** button and then touch [Eject SD].
- 2 Touch [Yes].

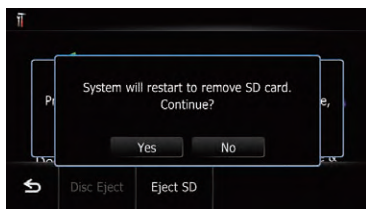

The navigation system restarts, and a message prompting you to remove the SD memory card appears.

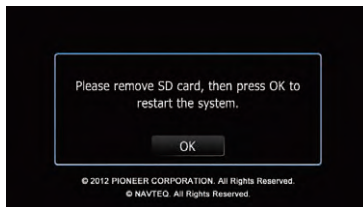

- 3 Eject the SD memory card while the message is displayed.

Eject the SD memory card before touching [OK].

- 4 Touch [OK].

The navigation system restarts. ☐

## Plugging and unplugging a USB storage device

### ⚠ CAUTION

- To prevent data loss and damage to the storage device, never remove it from this navigation system while data is being transferred.
- Pioneer cannot guarantee compatibility with all USB mass storage devices and assumes no responsibility for any loss of data on media players, smart phones, or other devices while using this product.

- ☐ This navigation system may not achieve optimum performance with some USB storage devices.
- ☐ Connection via a USB hub is not possible.

## Plugging in a USB storage device

- Plug a USB storage device into the USB and mini-jack connector.

USB and mini jack connector

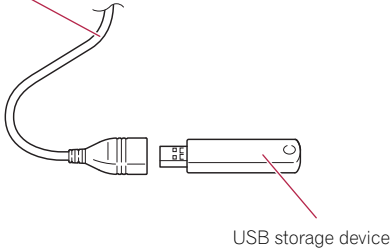

## Unplugging a USB storage device

- Pull out the USB storage device after checking that no data is being accessed.

## Connecting and disconnecting an iPod

### CAUTION

- To prevent data loss and damage to the storage device, never remove it from this navigation system while data is being transferred.
- Pioneer cannot guarantee compatibility with all USB mass storage devices and assumes no responsibility for any loss of data on media players, smart phones, or other devices while using this product.

## Connecting your iPod

Using the USB interface cable for iPod enables you to connect your iPod to the navigation system.

- A USB interface cable for iPod (CD IU51V) (sold separately) is required for connection.
- For details about iPod compatibility with this navigation system, refer to the information on our website.
- Connection via a USB hub is not possible.

- 1 Check that no USB storage device is connected.
- 2 Connect your iPod.

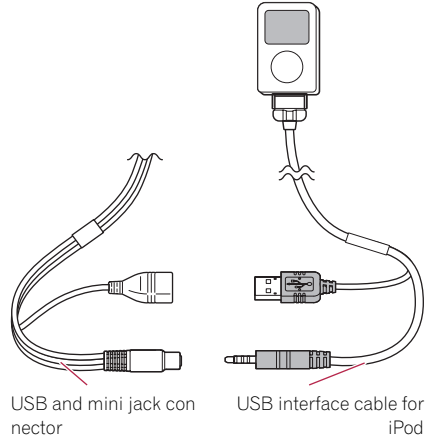

## Disconnecting your iPod

- Pull out the USB interface cable for iPod after checking that no data is being accessed.

## Basic operation

### Startup and termination

#### 1 Start the engine to boot up the system.

After a short pause, the splash screen comes on for a few seconds.

- To protect the LCD screen from damage, be sure to touch the touch panel keys with your finger only and gently touch the screen.

#### 2 Turn off the vehicle engine to terminate the system.

The navigation system is also turned off.

### On first-time startup

When you use the navigation system for the first time, select the language that you want to use.

#### 1 Start the engine to boot up the system.

After a short pause, the splash screen comes on for a few seconds.

#### 2 Touch the language that you want to use on the screen.

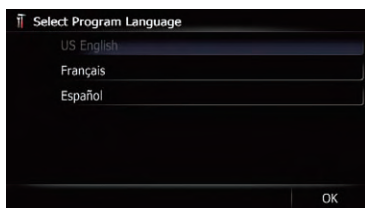

#### 3 Touch the language that you want to use for the voice guide.



The navigation system will now restart.

#### 4 Read the disclaimer carefully, checking its details, and then touch [OK] if you agree to the conditions.



The map screen appears.

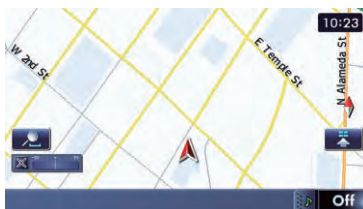

### Regular startup

#### ● Start the engine to boot up the system.

After a short pause, the splash screen comes on for a few seconds.

- The screen shown will differ depending on the previous conditions.
- When there is no route, the disclaimer appears after the navigation system reboots. Read the disclaimer carefully, checking its details, and then touch **[OK]** if you agree to the conditions.
- If the anti theft function is activated, you must enter your password. Read the disclaimer carefully, checking its details, and then touch **[OK]** if you agree to the conditions.

## A message about the map database

After you start using this navigation system, a message related to map data may be displayed.

- This message is displayed the first time you turn on the navigation system each month.
- Touch the message to close it or it will disappear automatically after eight seconds.

## Demonstration images

If you do not operate this navigation system for two minutes, demonstration images are displayed.

- The demonstration images will not be displayed if you drive after mounting this navigation system.



# Basic operation

### Screen switching overview

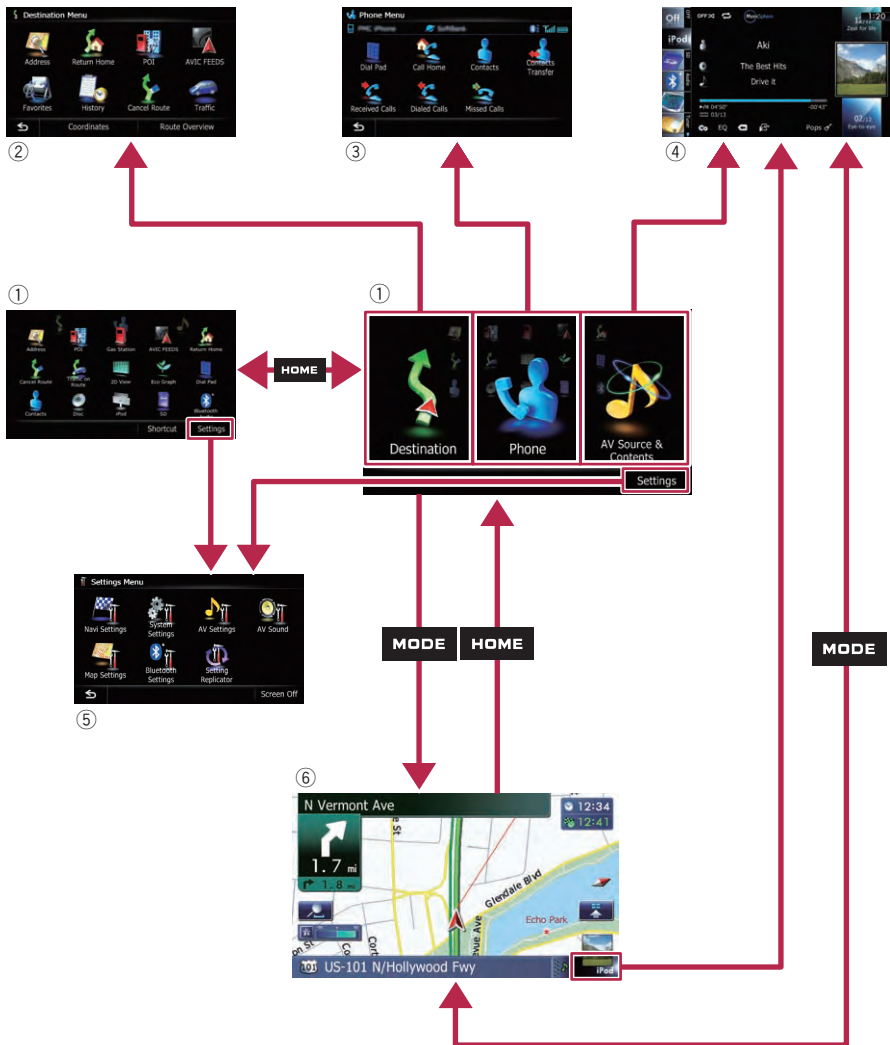

# How to use the navigation menu screens

## What you can do on each menu

### ① Top Menu

Press the **HOME** button to display the "**Top Menu**" screen.

This is the starting menu to access the desired screens and operate the various functions.

There are two types of the "**Top Menu**" screen.

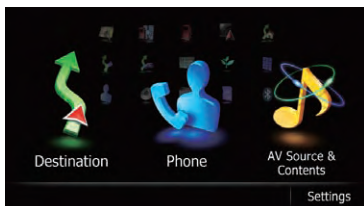

### Classic Menu



### Shortcut Menu

□ In this manual, Classic Menu will be referred to as "**Top Menu**".

### ② Destination Menu

You can search for your destination on this menu. You can also check or cancel your set route from this menu.

### ③ Phone Menu

You can access the screen that is related to hands free phoning.

### ④ AV operation screen

This is the screen that normally appears when you play the AV source.

### ⑤ Settings Menu

You can access the screen to customize settings.

### ⑥ Map screen

You can use this screen to check the current vehicle position information and route to the destination. □

## Shortcut Menu

Registering your favorite menu items in shortcuts allows you to quickly jump to the registered menu screen by a simple touch on the Shortcut Menu screen.

### Selecting the shortcut

□ Up to 15 menu items can be registered in shortcuts.

#### 1 Press the HOME button repeatedly to display the Shortcut Menu screen.

□ When you use the navigation system for the first time or no items are set on shortcut, a message will appear. Touch **[Yes]** to proceed to next step.

#### 2 Touch [Shortcut].

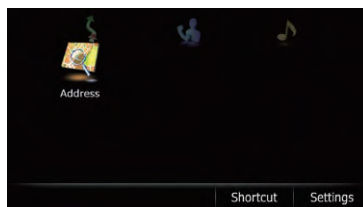

The Shortcut selection screen appears.

#### 3 Touch the tab on the right edge or scroll the bar to display the icon that you want to set to shortcut.



Scroll bar

#### 4 Touch and hold the icon that you want to add to shortcut.

## How to use the navigation menu screens

### 5 Move the icon to the left side of the screen, and then release it.

The selected item is added to shortcut.

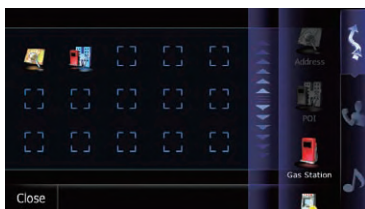

### Removing a shortcut

1 Touch and hold the icon of the shortcut you want to remove.

2 Move the icon to the right side of the screen, and then release it.

### Operating list screens (e.g. POI list)

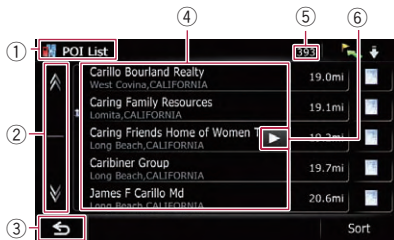

1 **Screen title**

2

Touching or on the scroll bar scrolls through the list and allows you to view the remaining items.

3

The previous screen returns.

4 **Listed items**

Touching an item on the list allows you to narrow down the options and proceed to the next operation.

5 **Number of possible choices**

If there are 10 000 or more possible choices, "\*\*\*\*" is displayed.

6

If all of the characters cannot be displayed within the displayed area, touching the key to the right of the item allows you to see remaining characters.

### Operating the on-screen keyboard

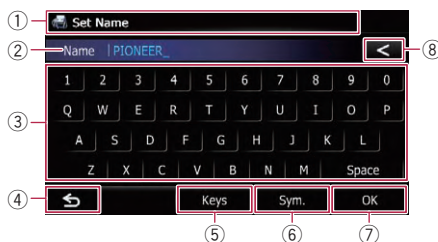

1 **Screen title**

The screen title appears.

2 **Text box**

Displays the characters that are entered. If there is no text in the box, an informative guide with text appears.

3 **Keyboard**

Touch the keys to enter the characters.

4

The previous screen returns.

5 **Keys**

Switches the on screen keyboard layout.

6 **Sym., Others, 0-9**

You can enter other characters of alphabet.

You can also enter text with marks such as [ & ] or [ + ] or numbers.

Touch to toggle the selection.

Even if you use any of "A", "Ä", "Å", "Æ", the displayed result is the same.

7 **OK**

Confirms the entry and allows you to proceed to the next step.

8

Deletes the input text one letter at a time, beginning at the end of the text. Continuing to touch the key deletes all of the text.

## How to use the map

Most of the information provided by your navigation system can be seen on the map. You need to be come familiar with how information appears on the map.

### How to read the map screen

This example shows an example of a 2D map screen.

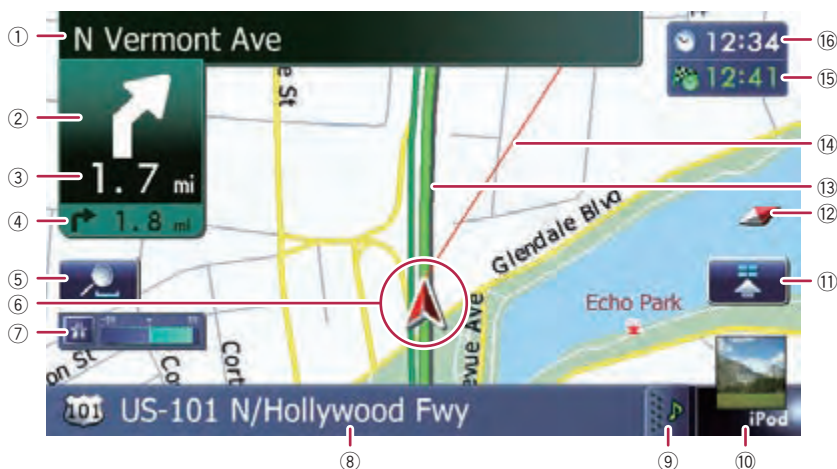

- ❑ Information with an asterisk (\*) appears only when the route is set.
- ❑ Depending on the conditions and settings, some items may not be displayed.

① **Name of the street to be used (or next guidance point)\***

② **Next direction of travel\***

As you get closer to the guidance point, the color of the item changes to green.

- ❑ Touching this item enables you to hear the next guidance again.
- ❑ You can select between display and non display.

➔ For details, refer to *Displaying maneuvers* on page 166.

③ **Distance to the guidance point\***

Shows the distance to the next guidance point.

- ❑ Touching this item enables you to hear the next guidance again.

④ **Second maneuver arrow\***

Shows the turning direction after next guidance point and the distance to there.

➔ For details, refer to *Displaying maneuvers* on page 166.

⑤ **Map control**

Touching  displays touch panel keys for changing the map scale and the map orientation.

⑥ **Current position**

Indicates the current location of your vehicle. The apex of the triangular mark indicates your orientation and the display moves automatically as you drive.

- ❑ The apex of the triangular mark is the proper current position of the vehicle.

⑦ **Eco-Meter**

Displays a graph comparing the past average fuel mileage and the average fuel mileage since the navigation system was last started.

➔ For details, refer to *Displaying the fuel consumption information* on page 167.

## How to use the map

### ⑧ Street name (or city name) that your vehicle is traveling along

➡ For details, refer to *Setting the current street name display* on page 165.

### ⑨ Extension tab for the AV information bar

Touching this tab opens the AV information bar and enables you to briefly view the current status on the AV source. Touching it again retracts the bar.

### ⑩ Shortcut to the AV operation screen

The AV source currently selected is shown. Touching the indicator displays the AV operation screen of the current source directly.

☐ Depending on the source currently chosen, an image is displayed.

### ⑪ Quick Access icon

Displays the "Quick Access" menu.

➡ For details, refer to *Using shortcut menus on the map* on page 33.

### ⑫ Map orientation indicator

- When "North up" is selected,  is displayed.

- When "Heading up" is selected,  is displayed.

☐ The red arrow indicates north.

➡ For details, refer to *Switching the map or orientation* on page 32.

### ⑬ Current route\*

The route currently set is highlighted in color on the map. If a waypoint is set on the route, the route after the next waypoint is highlighted in another color.

### ⑭ Direction line\*

The direction towards your destination (next waypoint, or the position of a cursor) is indicated with a straight line.

### ⑮ Multi-Info window

Each touch of Multi Info window changes the display information as follows.

- **Distance to the destination (or distance to waypoint)\***
- **Estimated time of arrival at your destination or waypoint\***

The estimated time of arrival is an ideal value calculated based on the value set for "Average Speed" and the actual driving speed. The estimated time of ar

ival is only a reference value, and does not guarantee arrival at that time.

- **Travel time to your destination or waypoint\***

### ⑯ Current time

## Meaning of guidance flags



#### Destination

The checkered flag indicates your destination.



#### Waypoint

The blue flags indicate your waypoints.



#### Guidance point

The next guidance point (next turning point, etc.) is shown by a yellow flag.

## Enlarged map of the intersection

When "Close Up View" in the "Map Settings" screen is "On", an enlarged map of the intersection appears.



➡ For details, refer to *Setting the auto zoom display* on page 164.

## How to use the map

### Display during freeway driving

In certain locations of the freeway, lane information is available. The map indicates the recommended lane to be in to easily maneuver the next guidance.

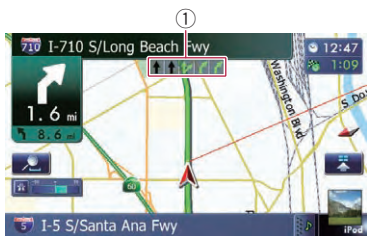

While driving on the freeway, freeway exit numbers and freeway signs may be displayed in the vicinity of interchanges and exits.



① **Lane information**

② **Freeway exit information**

Displays the freeway exit.

③ **Freeway signs**

These show the road number and give directional information.

- ❑ If the data for these items is not contained in the built-in memory, the information is not available even if there are the signs on the actual road. ❑

## Types of the road stored in the map database

### Roads included in the route guidance

Turn by turn routable roads contain full attribute data and can be used for full route guidance. Pioneer navigation will display full route guidance, including turn by turn voice directions and arrow icons.

### Roads without turn-by-turn instructions

Routable roads (the route displayed and highlighted in violet) have only basic data and can only be used to plot a navigable route. Pioneer Navigation will only display a navigable route on the map (only the arrival guidance for the destination or a waypoint is available). Please review and obey all local traffic rules along the highlighted route for your safety.

No turn by turn directions will be displayed on these roads.

### Non routable roads (pink color road)

Map display is possible, but it cannot be used for route calculation. Please review and obey all local traffic rules along this route. (For your safety.) ❑

## Operating the map screen

### Changing the scale of the map

You can change the map scale between 25 yards and 1 000 miles (25 meters and 2 000 kilometers).

#### 1 Display the map screen.

- For details of the operations, refer to *Screen switching overview* on page 26.

#### 2 Touch on the map screen.

 and  with the map scale appear.

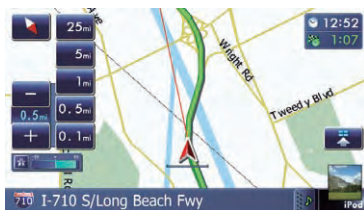

#### 3 Touch or to change the map scale.

- ❑ If you do not operate the function for a few seconds, the touch panel keys for map display control disappear.
- If you touch the direct scale key, the map is changed to the selected scale directly.

## How to use the map

### Switching the map orientation



You can switch how the map shows your vehicle's direction between "Heading up" and "North up".

- **Heading up:**  
The map display always shows the vehicle's direction as proceeding toward the top of the screen.
  - **North up:**  
The map display always has north at the top of the screen.
- The map orientation is fixed at "North up" when the map scale is 25 miles (50 kilometers) or more.
  - The map orientation is fixed at "Heading up" when the 3D map screen is displayed.

#### 1 Display the map screen.

- ➔ For details of the operations, refer to *Screen switching overview* on page 26.

#### 2 Touch on the map screen.

 or  appears.

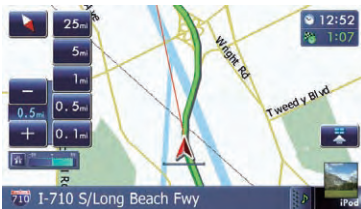

#### 3 Touch or to switch the vehicle's direction.

Each time you touch the key changes the setting.

- If you do not operate the function for a few seconds, the touch panel keys for map display control disappear.

### Scrolling the map to the position you want to see

#### 1 Display the map screen.

- ➔ For details of the operations, refer to *Screen switching overview* on page 26.

#### 2 Touch and drag the map in the desired direction to scroll.

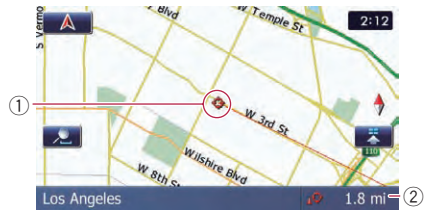

① Cursor

② Distance from the current position

Positioning the cursor to the desired location results displaying in a brief informational overview about the location at the bottom of screen, with the street name and other information for this location. (The information shown varies depending on the position.)

- The scrolling increment depends on your dragging length.
- If you touch , the map returns to the current position.
- Pressing **MODE** button returns the map to the current position.

### Viewing information about a specified location

An icon appears at registered places (home location, specific places, **Favorites** entries) and places where there is a POI icon or traffic information icon. Place the scroll cursor over the icon to view detailed information.

#### 1 Scroll the map and move the scroll cursor to the icon you want to view.

#### 2 Touch .

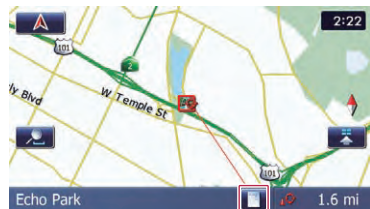

The "Information List" screen appears.



## How to use the map

### 3 Touch the item that you want to check the detailed information.

Information for a specified location appears.

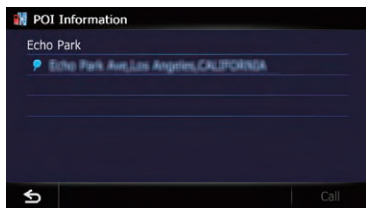

The information shown varies according to the location. (There may be no information for that location.)

- ➔ For details, refer to *Setting the display of icons of favorite locations* on page 166.
- ➔ For details, refer to *Displaying POI on the map* on page 167.
- ➔ For details, refer to *How to read traffic information on the map* on page 55.
- ☐ Touching [Call] enables you to call the position if a telephone number is available. (Pairing with cellular phone featuring Bluetooth wireless technology is required.)
  - ➔ For details, refer to *Dialing from the map* on page 67.

### Using shortcut menus on the map

“Quick Access” menu allows you to perform various tasks, such as route calculation for the location indicated by the cursor or registering a location in “Favorites”, faster than using the navigation menu.

You can customize “Quick Access” displayed on screen. The “Quick Access” described here are prepared as the default setting.

- ➔ For details, refer to *Selecting the “Quick Access” menu* on page 169.
- ☐ Items marked with an asterisk (\*) cannot be removed from the “Quick Access” menu.

### ● When the map is displayed, touch .

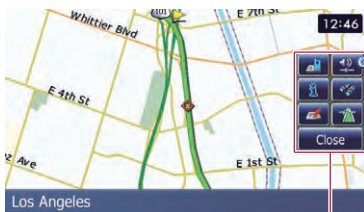

Quick Access menu

#### : Route Options\*

Displayed when the map is not scrolled. This item can be selected only during route guidance.

You can modify the conditions for route calculation and recalculate the current route.

- ➔ For details, refer to *Modifying the route calculation conditions* on page 46.

#### : Destination\*

Displayed when the map is scrolled. Set the route to the place specified with the cursor.

#### : Registration

Register information on the location indicated by the cursor to “Favorites”.

- ➔ For details, refer to *Registering a location by scroll mode* on page 50.

#### : Vicinity Search

Find POIs (Points Of Interest) in the vicinity of the cursor.

- ➔ For details, refer to *Searching for a nearby POI* on page 41.

#### : Overlay POI

Displays icons for surrounding facilities (POI) on the map.

- ➔ For details, refer to *Displaying POI on the map* on page 167.

#### : Volume

Displays the “Volume Settings” screen.

- ➔ For details, refer to *Setting the Volume for Guidance and Phone* on page 172.

#### : Contacts

Displays the “Contacts List” screen.

- ➔ For details, refer to *Calling a number in the phone book* on page 65.

#### Close

Hides the “Quick Access” menu. ☐

## Switching the view mode

Various types of screen displays can be selected for navigation guidance.

### 1 Display the “Map Settings” screen.



- ➔ For details, refer to *Displaying the screen for map settings* on page 163.

### 2 Touch [View Mode].

The “View Mode” screen appears.

### 3 Touch the type that you want to set.

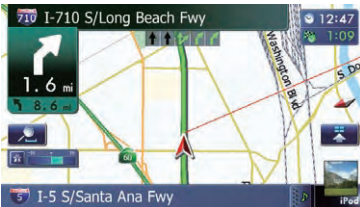
You can select the following types:

- **2D View** (default):  
Displays a normal map (2D map).  

- **3D View**:  
Displays a map with an antenna view (3D map).  

### • Street View:

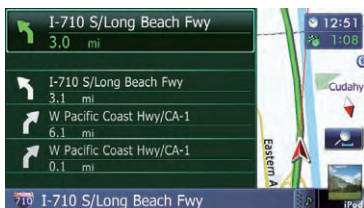
Information on the next four guidance points closest to the current location appear in order from top to bottom on the left side of the screen.



The following information is displayed.

- Name of the next route to be taken by the vehicle
- Arrow indicating the direction of the vehicle
- Distance to the guidance points
- This mode is available when the route is set.

### • Rear View:

Displays the rear view image on the left side of the screen and the map on the right side of the screen.



- This mode is available when the rear view camera setting is set to “On”.
- ➔ For details, refer to *Setting for rear view camera* on page 174.

### • Eco Graph:

Displays a graph for eco driving on the left side of the screen and the map on the right side of the screen.

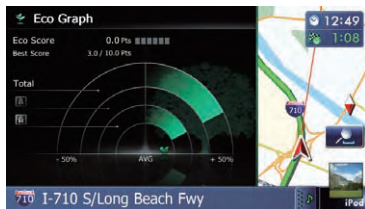

- ➔ For details, refer to *Checking the eco friendly driving status* on the next page.

## Eco-friendly driving functions

This navigation system is equipped with eco friendly driving functions that can be used to estimate whether you are driving in an environmentally friendly way.

This chapter describes these functions.

- The fuel mileage calculated is based on a theoretical value determined from vehicle speed and position information from the navigation system. The fuel mileage displayed is only a reference value, and does not guarantee the mileage displayed can be obtained.
- The eco friendly driving functions are an estimate of the real time fuel consumption to average fuel consumption ratio and is not an actual value.
- The eco friendly driving functions and calculations take into consideration the location of the GPS position and speed of the vehicle in determining a value.

### Checking the eco-friendly driving status

This function estimates approximate fuel mileage based on your driving, compares that with your average fuel mileage in the past, and displays the results in a graph.

The graph appears when the map display is set to **"Eco Graph"**.

#### 1 Display the "Map Settings" screen.

- ➔ For details, refer to *Displaying the screen for map settings* on page 163.

#### 2 Touch [View Mode].

The **"View Mode"** screen appears.

#### 3 Touch [Eco Graph].

The **"Eco Graph"** screen appears.

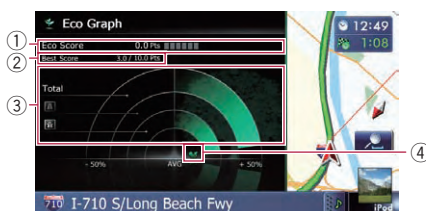

#### ① Eco Score

The result of the comparison of your past average fuel mileage and current average fuel mileage appears as a value from **0.0 Pts** (points) to **10.0 Pts**. The higher the value, the better the fuel mileage when compared to past route guidance.

The green gauge indicates the current score, and the gray gauge indicates the best score to date.

The **"Eco Score"** is updated every 5 minutes.

- This is not displayed when **"Eco Score"** is set to **"Off"** or when no route is set.

#### ② Best Score

Displays the best score to date.

- This is not displayed when **"Eco Score"** is set to **"Off"** or when no route is set.

#### ③ Average fuel mileage comparison graph

Displays a comparison of the average fuel mileage up to the point the navigation system was last stopped (past average fuel mileage) and the current average fuel mileage. The display is updated every 3 seconds. The more the value moves in the direction of **+**, the better the fuel mileage. There are three different graph bars.

##### • Total

A comparison of the past average fuel mileage and the average fuel mileage of the current drive.

##### • : Ordinary Road

A comparison of the past average fuel mileage and the average fuel mileage for 90 seconds in the past, while the vehicle is driving on an ordinary road.

##### • : Freeway

A comparison of the past average fuel mileage and the average fuel mileage for 90 seconds in the past, while the vehicle is driving on a freeway.

④ **Animal icons**

The number of displayed animal icons increases or decreases according to the value of **"Eco Score"**.

- This is not displayed when **"Eco Score"** is set to **"Off"** or when no route is set.
- Even if you use the **"Eco Graph"** function immediately after you start using the navigation system for the first time, ☒ may be displayed and the function may not be available.
- ➡ For details, refer to *Troubleshooting* on page 199.
- The display settings can be changed.
- ➡ For details, refer to *Changing the eco function setting* on page 162.

## Displaying Eco Drive Level guidance

This navigation system is equipped with the **"Eco Drive Level"** function that estimates how well you have driven in an environmentally friendly way.

The points of **"Eco Drive Level"** change according to **"Eco Score"** when the vehicle reaches the destination. When a certain number of points is reached, the level increases and a message appears.

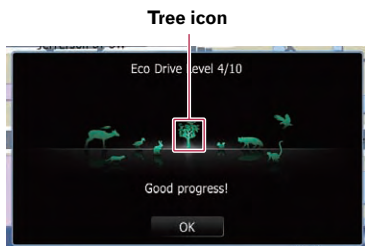

As the level increases, a tree icon changes from a young tree to a big tree.

- This is not displayed when **"Eco Drive Level"** is set to **"Off"**.
- ➡ For details of the operation, refer to *Changing the eco function setting* on page 162.

## Sudden start alert

If the speed of the vehicle exceeds 25.5 mph (41 km/h) within 5 seconds from the time it is started, a message appears and a warning sound beeps.

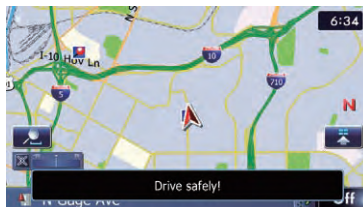

- ➡ For details of the operation, refer to *Changing the eco function setting* on page 162.

## Searching for and selecting a location

### CAUTION

For safety reasons, these route setting functions are not available while your vehicle is in motion. To enable these functions, you must stop in a safe place and put on the parking brake before setting your route.

- ❑ Some information regarding traffic regulations depends on the time when the route calculation is performed. Thus, the information may not correspond with a certain traffic regulation when your vehicle actually passes through the location in question. Also, the information on the traffic regulations provided will be for a passenger vehicle, and not for a truck or other delivery vehicles. Always follow the actual traffic regulations when driving.

### The basic flow of creating your route

- 1 Park your vehicle in a safe place and apply the parking brake.
 

↓
- 2 Display the "Destination Menu" screen.
  - For details of the operations, refer to *Screen switching overview* on page 26.

↓
- 3 Select the method of searching for your destination.
 

↓
- 4 Enter the information about your destination to calculate route.
 

↓
- 5 Confirm the location on the map.
  - For details, refer to *Setting a route to your destination* on page 45.

↓
- 6 The navigation system calculates the route to your destination, and then shows the route on the map.
 

↓
- 7 Check and decide the route.
  - For details, refer to *Setting a route to your destination* on page 45.

↓
- 8 Your navigation system sets the route to your destination, and the map of your surroundings appears.
 

↓
- 9 Release the parking brake, drive in accordance with navigation guidance.



## Searching for a location by address

The most frequently used function is “**Address**”, in which the address is specified and the destination is searched.

You can select the method of searching for a location by address.

- Searching for a city name first
- Finding the location by specifying the house number

## Searching for a city name first

- Depending on the search results, some steps may be skipped.
- When you enter characters, the system will automatically search the database for all possible options. Only the characters you enter are active.
- If the search candidates number reaches 20 or less, the screen automatically changes to the search result screen.

### 1 Display the “Destination Menu” screen.

- ➔ For details of the operations, refer to *Screen switching overview* on page 26.

### 2 Touch [Address].

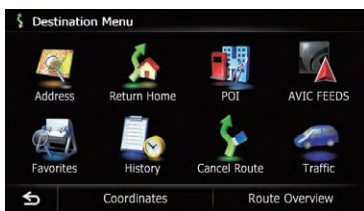

### 3 Touch the key next to “Country” to select the country.

If the destination is in another country, change the country setting.

- Once the country has been selected, you only have to change countries when your destination is outside of the country you selected.

### 4 Touch the key next to “State” and touch the desired state, province, or territory on the list.

If the location that you want to search for is in another state, province, or territory, this changes the area setting.

- Once the state, province, or territory has been selected, you only have to change states, provinces, or territories when your destination is outside of the state, province, or territory you selected.

### 5 Touch [City].



- If you touch [History], the “City History List” screen appears, enabling you to search by previously selected city history.
  - ➔ For details, refer to *Searching by selected city history* on page 40.

### 6 Enter the city name and then touch [OK].

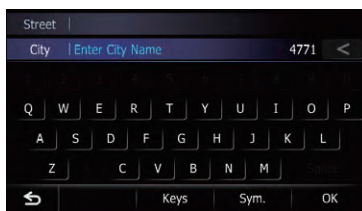

The “Select City” screen appears.

### 7 Touch the desired city name.

The “Street Name” screen appears.

- If you touch , the geographic center of the city appears on the map screen.

## Searching for and selecting a location

8 Enter the street name and then touch [OK].

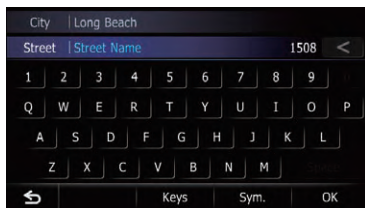

The “Street Selection” screen appears.

9 Touch the street you want.

10 Enter the house number and then touch [OK].



The “House Number Selection” screen appears.

- If you touch [OK] without entering the house number, a representative location on the street in the selected city appears.

11 Touch the desired house number range.

The searched location appears on the map screen.

- ➔ For the subsequent operations, refer to *Setting a route to your destination* on page 45.

### Finding the location by specifying the house number

- Depending on the search results, some steps may be skipped.
- When you enter characters, the system will automatically search the database for all possible options. Only the characters you enter are active.

- If the search candidates number reaches 20 or less, the screen automatically changes to the search result screen.

1 Display the “Address Search” screen.

2 Touch [House#].

The “Enter House Number” screen appears.

3 Enter the house number and then touch [OK].



The “Enter Street Name” screen appears.

4 Enter the street name and then touch [OK].



The “Street Selection” screen appears.

5 Touch the street you want.

The “Enter City Name” screen appears.

6 Enter the city name and then touch [OK].

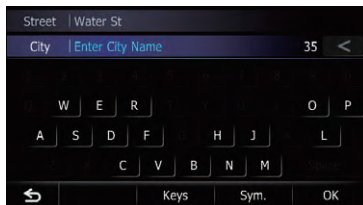

The “Select City” screen appears.

**7 Touch the desired city name.**

The “**House Number Selection**” screen appears.

If the house number you have entered is not found, a message appears. In that case, all house number ranges are listed after touching [**Yes**].

- If you touch , the geographic center of the city appears on the map screen.

**8 Touch the desired house number range.**

The searched location appears on the map screen.

- ➔ For the subsequent operations, refer to *Setting a route to your destination* on page 45.

**Searching by selected city history**

You can search the cities from the history that you have searched by entering the name with the keyboard and selected by “**Address**”, “**POI**” or “**Favorites**”.

- The history can store up to 50 cities.
- The cities are listed in order of the most recent search.

**1 Display the “Destination Menu” screen.**

- ➔ For details of the operations, refer to *Screen switching overview* on page 26.

**2 Touch [Address].**

The “**Address Search**” screen appears.

**3 Touch [History].**

The “**City History List**” screen appears.

**4 Touch the desired city name.**

The “**Street Name**” screen appears.

- If you touch , the geographic center of the city appears on the map screen.

**5 Enter the street name and then touch [OK].**

The “**Street Selection**” screen appears.

**6 Touch the street you want.**

The “**Enter House Number**” screen appears.

- If the selected street has only one matching location, the searched location appears on the map screen.

**7 Enter the house number and then touch [OK].**

The “**House Number Selection**” screen appears.

- If you touch [**OK**] without entering the house number, a representative location on the street in the selected city appears.

**8 Touch the desired house number range.**

The searched location appears on the map screen.

- ➔ For the subsequent operations, refer to *Setting a route to your destination* on page 45.

**Setting up a route to your home**

If your home location is stored, the route to your home can be calculated by touching a single key.

**1 Display the “Destination Menu” screen.**

- ➔ For details of the operations, refer to *Screen switching overview* on page 26.

**2 Touch [Return Home].**

- If you have not registered your home location, a message appears. Touch [**Register**] to start registration.
- ➔ For details, refer to *Registering your home* on page 162.

**Searching for Points of Interest (POI)**

Information about various facilities (Points Of Interest POI), such as gas stations, parking lots or restaurants, is available. You can search for a POI by selecting the category (or entering the POI Name).



## Searching for and selecting a location

### Searching for POIs by preset categories

You can search for POIs with a single touch from the preset category.

#### 1 Display the “Destination Menu” screen.

- ➔ For details of the operations, refer to *Screen switching overview* on page 26.

#### 2 Touch [POI].

#### 3 Touch the desired category.

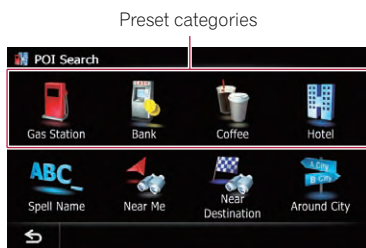

The “POI List” screen appears.

#### 4 Touch the POI you want.

The searched location appears on the map screen.

- ➔ For the subsequent operations, refer to *Setting a route to your destination* on page 45.

### Searching for a POI directly from the name of the facilities

- ☐ If the search candidates number reaches 20 or less, the screen automatically changes to the search result screen.

#### 1 Display the “Destination Menu” screen.

- ➔ For details of the operations, refer to *Screen switching overview* on page 26.

#### 2 Touch [POI].

The “POI Search” screen appears.

#### 3 Touch [Spell Name].

#### 4 Enter the POI name and then touch [OK].

The “POI List” screen appears.

- If you change the region to search, touch the state code key and display the “State List” screen to change the setting.

State code key

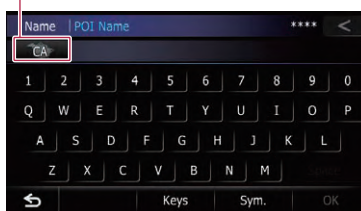



If the destination is in another country, touch [Country] to change the country setting when the “State List” screen is displayed.

- ☐ Once the region has been selected, you only have to change it when your destination is outside of the region you selected.

#### 5 Touch the POI you want.

The searched location appears on the map screen.

- If you touch [Sort], the order of POI can be sorted.
  - ☐ Current order is indicated on the upper right of the screen.
  - : Sorts the items in the list in order by distance from the vehicle position.
  - : Sorts the items in the list in order by degree of consistency with the entered text.
  - : Sorts the items in the list alphabetically.
- ➔ For the subsequent operations, refer to *Setting a route to your destination* on page 45.

### Searching for a nearby POI

You can search for POIs in your surroundings.

- ☐ Up to 300 POIs within a 100 miles (160 kilometers) radius of the vehicle position are listed in order by distance.

**1 Display the “Destination Menu” screen.**

- ➔ For details of the operations, refer to *Screen switching overview* on page 26.

**2 Touch [POI].**

The “**POI Search**” screen appears.

**3 Touch [Near Me].**

POIs are divided into several categories.

**4 Touch the category you want.**

The “**POI List**” screen appears.

- If there are more detailed categories within the selected category, repeat this step as many times as necessary.

**5 Touch the POI you want.**

The searched location appears on the map screen.

- ➔ For the subsequent operations, refer to *Setting a route to your destination* on page 45.

**Searching for POIs around the destination**

- This function is available when the route is set.

**1 Display the “Destination Menu” screen.**

- ➔ For details of the operations, refer to *Screen switching overview* on page 26.

**2 Touch [POI].**

The “**POI Search**” screen appears.

**3 Touch [Near Destination].**

POIs are divided into several categories.

**4 Touch the category you want.**

The “**POI List**” screen appears.

- If there are more detailed categories within the selected category, repeat this step as many times as necessary.

**5 Touch the POI you want.**

The searched location appears on the map screen.

- ➔ For the subsequent operations, refer to *Setting a route to your destination* on page 45.

**Searching for POIs around the city**

You can search for POIs around a specified city.

- If the search candidates number reaches 20 or less, the screen automatically changes to the search result screen.

**1 Display the “Destination Menu” screen.**

- ➔ For details of the operations, refer to *Screen switching overview* on page 26.

**2 Touch [POI].**

The “**POI Search**” screen appears.

**3 Touch [Around City].****4 Enter the city name and then touch [OK].**

The “**Select City**” screen appears.

- If you change the region to search, touch the state code key and display the “**State List**” screen to change the setting.

State code key

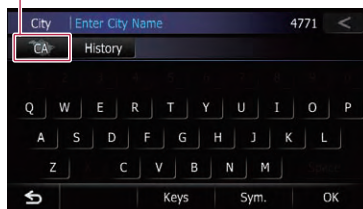

If the destination is in another country, touch [**Country**] to change the country setting when the “**State List**” screen is displayed.

- Once the region has been selected, you only have to change it when your destination is outside of the region you selected.
  - If you touch [**History**], the “**City History List**” screen appears, enabling you to search by previously selected city history.
    - ➔ For details, refer to *Searching by selected city history* on page 40.

**5 Touch the desired city name.**

POIs are divided into several categories.

- If you touch , the geographic center of the city appears on the map screen.

## Searching for and selecting a location

### 6 Touch the category you want.

The "POI List" screen appears.

- If there are more detailed categories within the selected category, repeat this step as many times as necessary.

### 7 Touch the POI you want.

The searched location appears on the map screen.

- ➔ For the subsequent operations, refer to *Setting a route to your destination* on page 45.

### How to read the "POI List" screen

The following information is displayed on the "POI List" screen.

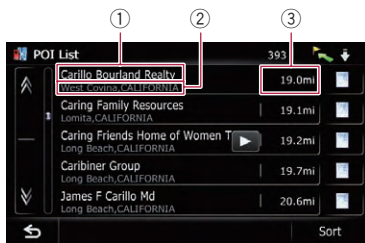

- ① Facility name
  - ② Facility address
  - ③ Distance from the position that the search starts
- If you touch , detailed information of the facility appears.

### Selecting destination from "Favorites"

Storing locations you visit frequently saves time and effort.

Selecting an item from the list provides an easy way to specify the position.

- This function is not available if no locations have been registered in "Favorites".
- ➔ For details, refer to *Storing favorite locations* on page 50.

### 1 Display the "Destination Menu" screen.

- ➔ For details of the operations, refer to *Screen switching overview* on page 26.

### 2 Touch [Favorites].

### 3 Touch the entry you want.



The searched location appears on the map screen.

- ➔ For the subsequent operations, refer to *Setting a route to your destination* on page 45.

### Searching for POIs by using the data on the SD memory card

Creating a customized POI is possible by using the utility program AVIC FEEDS which is available separately, on your PC. (AVIC FEEDS will be available on our website.) Storing the customized POI properly and inserting the SD memory card enables the system to use the data for searches.

### 1 Store the item into the SD memory card by using the AVIC FEEDS.

### 2 Insert an SD memory card into the SD card slot.

- ➔ For details of the operation, refer to *Inserting and ejecting an SD memory card* on page 18.

### 3 Display the "Destination Menu" screen.

- ➔ For details of the operations, refer to *Screen switching overview* on page 26.

**4 Touch [AVIC FEEDS].**

The “Select POI” screen appears.

**5 Touch the item you want.****6 Touch the POI you want.**

The searched location appears on the map screen.

- ➔ For the subsequent operations, refer to *Setting a route to your destination* on the next page. 

## Selecting a location you searched for recently

The places that you have set as destination or waypoint in the past are automatically stored in “History”.

- If no location is stored in Destination History, you cannot select [History]. (If you perform a route calculation, you can select [History].)
- “History” can store up to 100 locations. If the entries reach the maximum, the new entry overwrites the oldest one.

**1 Display the “Destination Menu” screen.**

- ➔ For details of the operations, refer to *Screen switching overview* on page 26.

**2 Touch [History].****3 Touch the entry you want.**

The searched location appears on the map screen.

- ➔ For the subsequent operations, refer to *Setting a route to your destination* on the next page. 

## Searching for a location by coordinates

Entering a latitude and longitude pinpoints the location.

**1 Display the “Destination Menu” screen.**

- ➔ For details of the operations, refer to *Screen switching overview* on page 26.

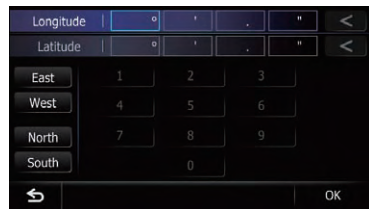
**2 Touch [Coordinates].****3 Touch [East] or [West], and then enter the longitude.**

To enter W 50°1'2.5" for example, touch [West], [0], [5], [0], [0], [1], [0], [2], and [5].

**4 Touch [North] or [South], and then enter the latitude.**

To enter N 5°1'2.5" for example, touch [North], [0], [5], [0], [1], [0], [2], and [5].

**5 Touch [OK].**

The searched location appears on the map screen.

- ➔ For the subsequent operations, refer to *Setting a route to your destination* on the next page. 

## After the location is decided

### Setting a route to your destination

#### 1 Search for a location.

- For details, refer to Chapter 6.

After searching for the destination, the Location confirmation screen appears.

#### 2 Touch [OK].

##### Location confirmation screen

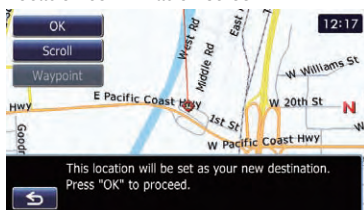

The destination is set, and then route calculation starts.

When the route calculation is completed, Route confirmation screen appears.

- If you press the **MODE** button during route calculation, the calculation is canceled and the map screen appears.
- If you touch [**Scroll**], the map display is changed to the scroll mode. In the scroll mode, you can display the location more precisely to register it, or make settings.
- If you touch [**Waypoint**], the location is added to the "Waypoints List" screen.
  - ☐ If a destination is not set, [**Waypoint**] is not available.

#### 3 Touch [OK].

##### Route confirmation screen

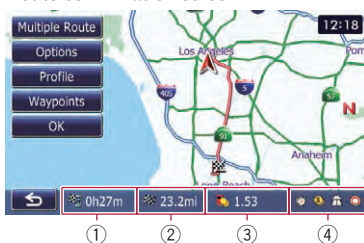

Sets the displayed route as your route, and starts the route guidance.

- ① Travel time to your destination

- ② Distance to the destination
- ③ Estimated fuel cost to your destination
  - For details, refer to *Inputting the fuel consumption information for calculating the fuel cost* on page 159.
- ④ Route calculation condition
  - If you touch **[S]**, the message confirming whether to cancel the calculated route appears. If you touch [**Yes**], the calculated route is canceled and the map screen appears.

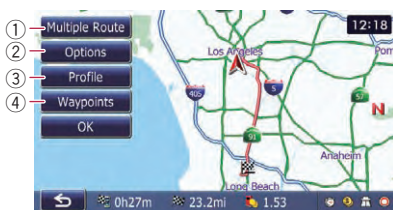

- ① **Multiple Route**
  - For details, refer to *Displaying multiple routes* on this page.
- ② **Options**
  - For details, refer to *Modifying the route calculation conditions* on the next page.
- ③ **Profile**
  - For details, refer to *Checking the current itinerary* on page 47.
- ④ **Waypoints**
  - For details, refer to *Editing waypoints* on page 48.

### Displaying multiple routes

You can select a desired route from multiple route options. Calculated routes are shown in different colors.

- ☐ If you set waypoints, you cannot display multiple routes.

#### 1 Touch [Multiple Route] on the Route confirmation screen.

Multiple route options appear.

#### 2 Touch **[1]** to **[6]**.

Another route is displayed.

#### 3 Touch [OK].

Route confirmation screen appears. ☐

## Displaying the route overview

❑ “Route Overview” is active only when the route is set.

1 Press the HOME button to display the “Top Menu” screen.

2 Touch [Destination].

The “Destination Menu” screen appears.

3 Touch [Route Overview].

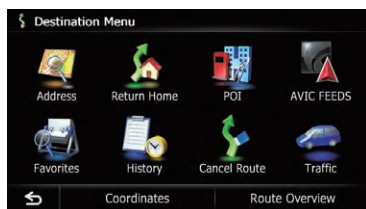

① Options

➤ For details, refer to *Modifying the route calculation conditions* on this page.

② Profile

➤ For details, refer to *Checking the current itinerary* on the next page.

③ Waypoints

➤ For details, refer to *Editing waypoints* on page 48.

4 Touch [OK].

## Modifying the route calculation conditions

You can modify the conditions for route calculation and recalculate the current route.

1 Display the “Route Overview” screen.

➤ For details, refer to *Displaying the route overview* on this page.

2 Touch [Options].

3 Touch the desired items to change the route calculation conditions and then touch [OK].

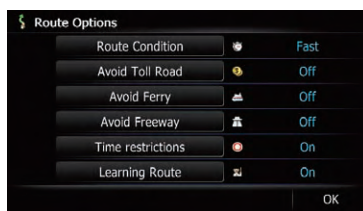

The route is recalculated, and the Route confirmation screen appears.

## Items that users can operate

Settings marked with an asterisk (\*) show that these are default or factory settings.

### Route Condition

This setting controls how the route should be calculated by taking into account the time, distance or main road.

Determines which condition takes priority for route calculation.

#### Fast\*:

Calculates a route with the shortest travel time to your destination as a priority.

#### Short:

Calculates a route with the shortest distance to your destination as a priority.

#### Main Road:

Calculates a route that passes major arterial roads as a priority.

## Checking and modifying the current route

### Avoid Toll Road

This setting controls whether toll roads (including toll areas) should be taken into account.

#### Off\*:

Calculates a route that may include toll roads (including toll areas).

#### On:

Calculates a route that avoids toll roads (including toll areas).

- The system may calculate a route that includes toll roads even if “On” is selected.

### Avoid Ferry

This setting controls whether ferry crossings should be taken into account.

#### Off\*:

Calculates a route that may include ferries.

#### On:

Calculates a route that avoids ferries.

- The system may calculate a route that includes ferries even if “On” is selected.

### Avoid Freeway

This setting controls whether freeways may be included in the route calculation.

#### Off\*:

Calculates a route that may include freeways.

#### On:

Calculates a route that avoids freeways.

- The system may calculate a route that includes freeways even if “On” is selected.

### Time restrictions

This setting controls whether streets or bridges that have traffic restrictions during a certain time should be taken into account.

- If you want to set your route to avoid raised draw bridges, select “On”.

#### On\*:

Calculates a route while avoiding streets or bridges with traffic restrictions during a certain time.

#### Off:

Calculates a route while ignoring traffic restrictions.

- The system may calculate a route that includes streets or bridges that are subject to traffic restrictions during a certain time even if “On” is selected.

### CAUTION

If the time difference is not set correctly, the navigation system cannot consider traffic regulations correctly. Set the time difference correctly.

- ➔ For details, refer to *Setting the time difference* on page 171.

### Learning Route

The system learns the travel history of your vehicle for each road.

This setting controls whether or not the travel history should be taken into account.

#### On\*:

Calculates a route with the travel history taken into account.

#### Off:

Calculates a route without the travel history taken into account.

#### Clear:

Clears the current travel history.

## Checking the current itinerary

You can check the route details.

### 1 Display the “Route Overview” screen.

- ➔ For details, refer to *Displaying the route overview* on the previous page.

### 2 Touch [Profile].

The “Route Profile” screen appears.



## Editing waypoints

You can edit waypoints (locations you want to visit on the way to your destination) and recalculate the route so that it passes through these locations.

## Adding a waypoint

Up to 5 waypoints can be set, and waypoints and final destination can be sorted automatically or manually.

### 1 Display the “Route Overview” screen.

- ➔ For details, refer to *Displaying the route overview* on page 46.

### 2 Touch [Waypoints].

The “Waypoints List” screen appears.

### 3 Touch [Add].



The “Select Search method” screen appears.

### 4 Search for a location.

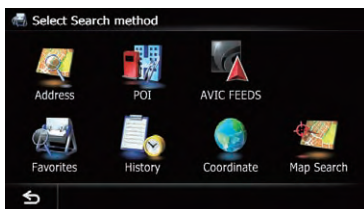

- ➔ For details, refer to Chapter 6.

### 5 Touch [OK].

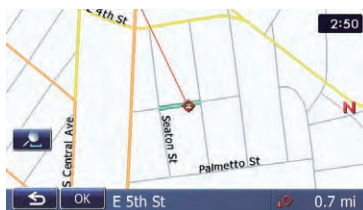

### 6 Touch [OK] on the “Waypoints List” screen.



The route is recalculated, and the Route confirmation screen appears.

- ☐ If you set waypoints, you cannot display multiple routes.

## Deleting a waypoint

You can delete waypoints from the route and then recalculate the route. (You can delete successive waypoints.)

### 1 Display the “Route Overview” screen.

- ➔ For details, refer to *Displaying the route overview* on page 46.

### 2 Touch [Waypoints].

The “Waypoints List” screen appears.

### 3 Touch [Delete] next to the waypoint that you want to delete.

The touched waypoint will be deleted from the list.

### 4 Touch [OK] on the “Waypoints List” screen.

The route is recalculated, and the Route confirmation screen appears.

### 5 Touch [OK].

The map of the current position appears.



## Checking and modifying the current route

### Sorting waypoints

You can sort waypoints and recalculate the route.

- You cannot sort waypoints that you have already passed.

#### 1 Display the “Route Overview” screen.

- For details, refer to *Displaying the route overview* on page 46.

#### 2 Touch [Waypoints].

The “Waypoints List” screen appears.

#### 3 Touch [Sort].

The “Sort Waypoints” screen appears.

#### 4 Touch the waypoint or destination.



Put them in the desired order.

- If you touch [**Automatic**], the destination and waypoints are sorted in the order of a nearest waypoint from the current location in the direct antenna path.
- If you touch [**Clear**], waypoint sort is canceled.

#### 5 Touch [OK].

The “Waypoints List” screen appears.

#### 6 Touch [OK] on the “Waypoints List” screen.

The route is recalculated, and the Route confirmation screen appears.

#### 7 Touch [OK].

The map of the current position appears.

## Canceling the route guidance

If you no longer need to travel to your destination, follow the steps below to cancel the route guidance.

#### 1 Display the “Destination Menu” screen.

- For details of the operations, refer to *Screen switching overview* on page 26.

#### 2 Touch [Cancel Route].

A message confirming the cancellation of the current route appears.

#### 3 Touch [Yes].

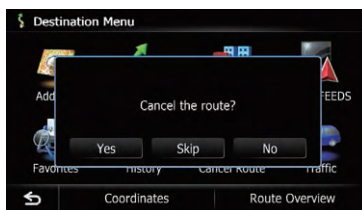

The current route is deleted, and a map of your surroundings reappears.

- If you touch [**Skip**], the next waypoint is skipped and a new route is calculated. All other waypoints remain.

When the route calculation is completed, Route confirmation screen appears.

- [**Skip**] is available only when a waypoint is set.
- If you touch [**No**], the previous screen returns without deleting the route.

## Storing favorite locations

Storing your favorite locations as “Favorites” provides you with the opportunity to save the time and effort of re entering this information. Stored items can be made available on “Favorites” later.

### Registering a location by “Favorites”

“Favorites” can store up to 400 locations. Home location is counted as one of the items in “Favorites”.

#### 1 Display the “Destination Menu” screen.

- For details of the operations, refer to *Screen switching overview* on page 26.

#### 2 Touch [Favorites].

The “Favorites” screen appears.

#### 3 Touch [Add].

The “Select Search method” screen appears.

#### 4 Search for a location.

- For details about the search methods, refer to Chapter 6.

#### 5 When the map of the location you want to register is displayed, touch [OK].

The location is registered, and then the “Edit Favorite” screen appears.

- For details, refer to *Editing the favorite location in the list* on this page.

#### 6 Touch [OK].

The registration is complete.

### Registering a location by scroll mode

- ☐ This function is available when “Registration” is set in the “Quick Access” menu.
  - For details, refer to *Selecting the “Quick Access” menu* on page 169.

#### 1 Touch and drag the screen to scroll the map to the position that you want to register.



#### 2 Touch to display the “Quick Access” menu.

#### 3 Touch .

The location is registered, and then the “Edit Favorite” screen appears.

- For details, refer to *Editing the favorite location in the list* on this page.

#### 4 Touch [OK].

The registration is complete. 

## Editing registered locations

### Editing the favorite location in the list

#### 1 Display the “Destination Menu” screen.

- For details of the operations, refer to *Screen switching overview* on page 26.

#### 2 Touch [Favorites].

The “Favorites” screen appears.

#### 3 Touch next to the location that you want to edit.

The “Edit Favorite” screen appears.

#### 4 Touch the item that you want to change the setting.

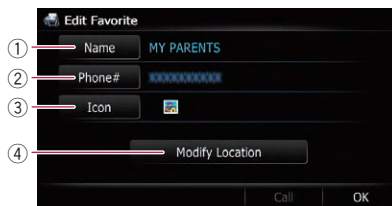

## Registering and editing locations

### ① Name

You can enter the desired name.

- Up to 17 characters can be input for the name.

### ② Phone#

You can edit the registered phone number. To dial the number, touch **[Call]**.

The maximum digits you can enter for the phone number is 15.

### ③ Icon

You can change the symbol displayed on the map and “Favorites”.

### ④ Modify Location

You can change the registered location by scrolling the map.

### 5 Touch **[OK]**.

The registration is complete.

## Editing your home

When you have already registered your home, you can edit the information of your home.

### 1 Display the “Destination Menu” screen.

- ➔ For details of the operations, refer to *Screen switching overview* on page 26.

### 2 Touch **[Favorites]**.

- Home location is displayed on the top of the list.

### 3 Touch next to the home location.



The “**Edit Favorite**” screen appears.

### 4 Touch the item that you want to change the setting.

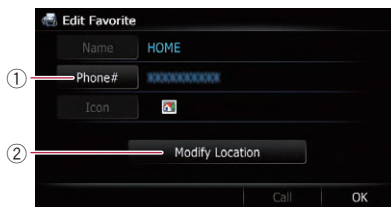

### ① Phone#

To dial the number, touch **[Call]**.

### ② Modify Location

You can change the registered location by scrolling the map.

- For home information, **[Name]** and **[Icon]** are not editable.

### 5 Touch **[OK]**.

The registration is complete.

## Sorting the favorite locations in the list

### 1 Display the “Destination Menu” screen.



- ➔ For details of the operations, refer to *Screen switching overview* on page 26.

### 2 Touch **[Favorites]**.

The “**Favorites**” screen appears.

### 3 Touch **[Sort]**.

Each time you touch **[Sort]** changes the sort order.

- Current order is indicated on the upper right of the screen.
  -  : Sorts the items in the list in order of the recently used items.
  -  : Sorts the items in the list alphabetically.
  -  : Sorts the items in the list in order by distance from the vehicle position.

## Deleting a favorite location from the list

### 1 Display the "Destination Menu" screen.

- For details of the operations, refer to *Screen switching overview* on page 26.

### 2 Touch [Favorites].

The "Favorites" screen appears.

### 3 Touch [Delete].

### 4 Select the location you want to delete.



A check mark appears next to the selected location.

- If you touch [All], you can select all entries. If you want to deselect all entries, touch [None].

### 5 Touch [Delete].



A message will appear asking you to confirm the deletion.

### 6 Touch [Yes].



The data you selected is deleted.

- If you touch [No], the deletion is canceled. □

## Exporting and importing favorite locations

### Exporting favorite locations

You can export the "Favorites" data to an SD memory card for editing by using the utility program AVIC FEEDS which is available separately, on your PC.

- If there is previous data in the SD memory card, the data is overwritten with new data.

### 1 Insert an SD memory card into the SD card slot.

- For details of the operation, refer to *Inserting and ejecting an SD memory card* on page 18.

### 2 Display the "Destination Menu" screen.

- For details of the operations, refer to *Screen switching overview* on page 26.

### 3 Touch [Favorites].

The "Favorites" screen appears.

### 4 Touch .

Data export starts.

After the data is exported, the completion message appears.



### 5 Touch [OK].

The "Favorites" screen appears.

## Importing favorite locations

You can import the locations that you have edited on the utility program AVIC FEEDS to "Favorites".

- When a location that is already registered in "Favorites" is imported, the location is overwritten.

### 1 Store the item into the SD memory card by using the AVIC FEEDS.

## Registering and editing locations

### 2 Insert an SD memory card into the SD card slot.

- For details of the operation, refer to *Inserting and ejecting an SD memory card* on page 18.

### 3 Display the “Destination Menu” screen.

- For details of the operations, refer to *Screen switching overview* on page 26.

### 4 Touch [Favorites].

The “Favorites” screen appears.

### 5 Touch [All].

The message confirming whether to replace the stored items appears.



### 6 Touch [Yes].

Data import starts.

After importing the data is finished, the “Favorites” screen appears.

## Deleting the destination history from the list

Items in “History” can be deleted. All entries in “History” can be deleted at once.

### 1 Display the “Destination Menu” screen.

- For details of the operations, refer to *Screen switching overview* on page 26.

### 2 Touch [History].

The “Destination History List” screen appears.

### 3 Touch [Delete].

The “Delete from History” screen appears.

### 4 Select the location you want to delete.

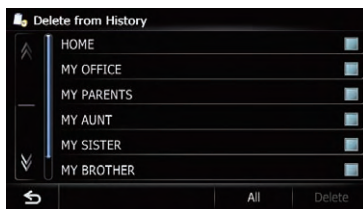

A check mark appears next to the selected location.

- If you touch [All], you can select all entries. If you want to deselect all entries, touch [None].

### 5 Touch [Delete].



A message will appear asking you to confirm the deletion.

### 6 Touch [Yes].

The data you selected is deleted.

- If you touch [No], the deletion is canceled.

- ❑ Please note that use of the traffic information function on AVIC X940BT will require that a separately sold Traffic tuner (ND TMC10) be connected.

You can check real time traffic information transmitted by the Traffic Management Channel (TMC) of the receive data services (RDS) on the screen. Such traffic information is updated periodically. When the navigation system receives updated traffic information, the navigation system will overlay the traffic information on your map and also display detailed text information when available. When you are traveling along a route and there is traffic information on your current route, the system will detect it and ask you if you would like to be rerouted, or suggest another route automatically.

- ❑ When used in North America, this product receives traffic information provided by Clear Channel Broadcasting, Inc. © Clear Channel Broadcasting, Inc.
- ❑ The system acquires the traffic information up to 100 miles in radius from the vehicle position. (If there is a lot of traffic information around your vehicle, the radius will be shorter than 100 miles.)
- ❑ The navigation system provides the following functions by using the information from RDS TMC service:
  - Displaying a list of traffic information
  - Displaying traffic information on a map
  - Suggesting a route to avoid traffic congestion by using traffic information
- ❑ The term “traffic congestion” in this section indicates the following types of traffic information: stop and go, stopped traffic, closed/blocked roads. This information is always taken into consideration when checking your route, and the information related with these events cannot be turned off. If you select other traffic information in “**Traffic Settings**”, the information can be displayed in a list or on a map.
  - ➔ For details, refer to *Selecting traffic information to display* on page 58.

## Checking all traffic information

Traffic information except traffic flow information is listed on screen. This allows you to check how many traffic incidents have occurred, their location and their distance from your current position.

### 1 Display the “Destination Menu” screen.

- ➔ For details of the operations, refer to *Screen switching overview* on page 26.

### 2 Touch [Traffic].

The “**Traffic Menu**” screen appears.

### 3 Touch [Traffic Events].

The “**Traffic Event List**” screen appears. The list with received traffic information is shown.

### 4 Select an incident you want to view in detail.



The details of the selected incident are displayed.

- ❑ Touching an incident you want to see allows you to view the detailed information of the incident. If the information cannot be displayed on one screen, touch or to view the remaining information.
- ❑ Touching allows you to check the location on a map. (Traffic information without positional information cannot be checked on a map.)
  - If you touch [**Sort**], the traffic information can be sorted. Each time you touch the key changes the setting.
    - : You can sort the traffic information by distance from your current position.

## Using traffic information

When you touch **[Traffic Events]**, the list displayed will be sorted according to the linear distance from the vehicle position to the traffic information.

When you touch **[Traffic on Route]**, the list displayed will be sorted according to the distance from the vehicle position to the traffic information.

- **ABC** :  
You can sort the traffic information in alphabetical order.
- **🚧** :  
You can sort the traffic information according to the incident.  
The list will be sorted in the order of closed/blocked roads, traffic congestion, accidents, road works and others.

Current order is indicated on the upper right of the screen.

- If you touch **[Refresh]** while new traffic information is received, current information is changed and old information is removed. The traffic information list is updated to reflect the new situation.

### 5 Touch **S**.

The previous screen returns. **▢**

## Checking traffic information on the route

All traffic information on the current route is displayed on screen in a list.

### 1 Display the "Destination Menu" screen.

- ➔ For details of the operations, refer to *Screen switching overview* on page 26.

### 2 Touch **[Traffic]**.

The "Traffic Menu" screen appears.

### 3 Touch **[Traffic on Route]**.

The "Traffic on Route" screen appears.

The method for checking the content displayed on the screen is the same as "Traffic Event List" screen.

- ➔ For details, refer to *Checking all traffic information* on the previous page. **▢**

## How to read traffic information on the map

The traffic event information displayed on the map is as follows.

- ▢ A line is displayed only when the map scale is 2.5 miles (5 km) or lower.
- ▢ Icons appear only when the scale on the map is 10 miles (20 km) or lower. If the scale is changed, the icons are resized according to the selected scale.

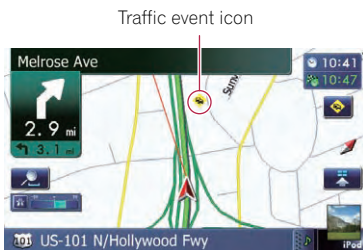

- **🚦** with yellow line:  
Stop and go traffic
- **🚦** with red line:  
Stopped traffic
- **🚫** with black line:  
Closed/blocked roads
- **🚧** etc.:  
Accidents, constructions, etc.
- ▢ For meanings of other icons, check them the "Traffic Type Settings" screen.
- ➔ For details of the operations, refer to *Selecting traffic information to display* on page 58. **▢**

## Viewing the traffic flow

All traffic flow information is displayed on screen in a list.

### 1 Display the "Destination Menu" screen.

- ➔ For details of the operations, refer to *Screen switching overview* on page 26.

### 2 Touch **[Traffic]**.

The "Traffic Menu" screen appears.



### 3 Touch [Traffic Flow].

A list with traffic flow information that has been received is shown. The list is sorted by distance from your current position.



Places (street names) where incidents have occurred are displayed on the list.

### 4 Select an incident you want to view in detail.

The details of the selected incident are displayed.

- ❑ Touching an incident you want to see allows you to view the detailed information of the incident. If the information cannot be displayed on one screen, touch  or  to view the remaining information.
- ❑ Touching  allows you to check the location on a map. (Traffic information without positional information cannot be checked on a map.)
- If you touch **[Sort]**, the traffic information can be sorted.

Each time you touch the key changes the setting.

- : You can sort the traffic information by the linear distance from your current position.
- : You can sort the traffic information in alphabetical order.
- : You can sort the traffic information by the average speed. The list will be sorted in the order of closed/blocked roads, traffic congestion, accidents, road works and others.

Current order is indicated on the upper right of the screen.

- If you touch **[Refresh]** while new traffic information is received, current information is changed and old information is removed. The traffic information list is updated to reflect the new situation.

- Touch .

The traffic event information displayed on the map is as follows.



Traffic flow icon and line

- **Red:** average speed in this area is slower than 15 mph (24 km/h)
- **Yellow:** average speed in this area is between 15 mph to 45 mph (24 km/h to 72 km/h)
- **Green:** average speed in this area is faster than 45 mph (72 km/h) (An icon without a line will be displayed) 

## Setting an alternative route to avoid traffic congestion

The navigation system checks at regular intervals whether or not there is the traffic information on your route. If the navigation system detects any traffic congestion on your current route, the system tries to find a better route in the background.

- ❑ The following types of traffic incidents on the route will be checked: stop and go, stopped traffic and closed/blocked roads except for closed freeway exits/entrances.



## Using traffic information

### Checking for traffic congestion automatically

If there is information about traffic congestion on your current route and if an alternative route can be found, the navigation system will recommend a new alternative route automatically. In such a case, the following screen will appear.



- ① Difference in distance and travel time between the existing route and new route.
  - ② Distance from the current position of your vehicle to the point of entry into the new route.
- There is no action if the system cannot find any traffic congestion information on your route or the system cannot find an alternative.

#### 1 Touch [New].

The recommended route is displayed on the screen.

- If you touch **[Current]** while the recommended route is displayed, the screen switches to the current route display.

#### 2 Touch [OK].

The displayed route is set.

- When no selection is made, the screen returns to the previous screen.

### Checking traffic information manually

Touching the notification icon on the map screen allows you to check traffic information on your route while the icon is displayed. The notification icon is only displayed on the navigation map screen if there is any traffic information on your route.

ation map screen if there is any traffic information on your route.

- The notification icon is not available if your vehicle deviates from the route.

#### 1 Set [Show Traffic Incident] to "View".

- For details, refer to *Displaying the traffic notification icon* on page 165.

#### 2 Display the map screen.

The icon appears when the system acquires traffic information on the current route.

- For details of the operations, refer to *Screen switching overview* on page 26.

#### 3 Touch the notification icon while the icon is displayed.

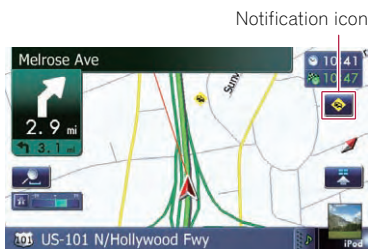

Traffic information on the current route is displayed on the map screen.

#### 4 Touch [Diversion] to search for an alternative route.

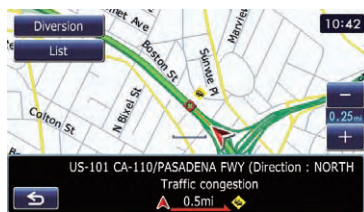

After touching **[Diversion]**, the route is recalculated taking all traffic congestion on your current route into account.

- [Diversion]** will be available only when the system can find traffic congestion.

- Notification icon shows the nearest traffic information on the route. However, if you touch **[Diversion]**, the route is recalculated by taking into account not only this information, but also all traffic congestion information on the route.
- ⇒ For details, refer to *Checking for traffic congestion automatically* on the previous page.
  - If you touch **[List]**, the “Traffic on Route” screen appears.
  - If you touch **[S]**, the message disappears and the map screen returns. □

## Selecting traffic information to display

There are different types of traffic information that can be received via the RDS TMC service, and you can select which types will be incorporated and displayed on your navigation system.

### 1 Display the “Destination Menu” screen.

- ⇒ For details of the operations, refer to *Screen switching overview* on page 26.

### 2 Touch **[Traffic]**.

The “Traffic Menu” screen appears.

### 3 Touch **[Traffic Settings]**.

The “Traffic Settings” screen appears.

### 4 Touch **[Displayed Traffic Info]**.

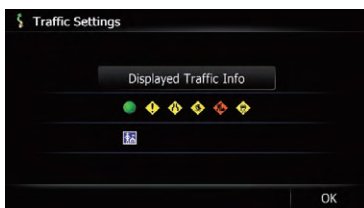

The “Traffic Type Settings” screen appears.

### 5 Touch the traffic information item to display.

A check mark appears next to the selected traffic information.

- If you touch **[All]**, you can select all entries. If you want to deselect all entries, touch **[None]**.

### 6 Touch **[OK]**.



The selected traffic information icon is added to the screen.

### 7 Touch **[OK]**. □

## Selecting preferred RDS-TMC service provider manually

A default preferred TMC service provider for each country has been set. The navigation system tunes to the radio station with good reception among the preferred RDS TMC service providers. If you want to set another preferred RDS TMC service provider, you can manually select one from available RDS TMC service providers.

### 1 Display the “Destination Menu” screen.

- ⇒ For details of the operations, refer to *Screen switching overview* on page 26.

### 2 Touch **[Traffic]**.

The “Traffic Menu” screen appears.

### 3 Touch **[TMC Provider Selection]**.

### 4 Touch the desired service provider on the list.

After touching a service provider, the system starts tuning to the selected RDS TMC service provider. When the tuning is successful, the system returns to the map display. □

## Registering and connecting a Bluetooth device

If your devices feature Bluetooth® technology, this navigation system can be connected to your devices wirelessly. This section describes how to set up a Bluetooth connection.

For details about the connectivity with the devices featuring Bluetooth wireless technology, refer to the information on our website.

### Preparing communication devices

This navigation system has a built-in function to use devices featuring Bluetooth wireless technology.

➔ For details, refer to *Notes for hands free phoning* on page 72.

You can register and use devices that feature the following profiles with this navigation system.

- HFP (Hands Free Profile)
- A2DP (Advanced Audio Distribution Profile)
- ❑ If the registered device features both HFP and A2DP, the hands free connection is made and then the Bluetooth audio connection is made.  
If the registered device features either profile, the corresponding connection is made.
- ❑ When the navigation system is turned off, the Bluetooth connection is also disconnected. When the system restarts, the system automatically attempts to reconnect the previously connected device. Even when the connection is severed for some reason, the system automatically reconnects the specified device (except when the connection is severed due to device operation). ❑

### Registering your Bluetooth devices

You need to register your devices featuring Bluetooth wireless technology when you con-

nect it for the first time. A total of 5 devices can be registered. Three registration methods are available:

- Searching for nearby Bluetooth devices
- Pairing from your Bluetooth devices
- Searching for a specified Bluetooth device
- ❑ If you try to register more than 5 devices, the system will ask you to select one of the registered devices to delete.
  - ➔ For details, refer to *Deleting a registered device* on page 62.

### Searching for nearby Bluetooth devices

The system searches for available Bluetooth devices near the navigation system, displays them in a list, and registers them for connection.

#### 1 Activate the Bluetooth wireless technology on your devices.

For some Bluetooth devices, no specific action is necessary to activate Bluetooth wireless technology. For details, refer to the instruction manual of your devices.

#### 2 Display the “Settings Menu” screen.

- ➔ For details of the operations, refer to *Screen switching overview* on page 26.

#### 3 Touch [Bluetooth Settings].

The “Bluetooth Settings” screen appears.

#### 4 Touch [Registration].

The “Nearby Device List” screen appears. The system searches for Bluetooth devices waiting for the connection and displays them in the list if a device is found.

- ❑ Up to 30 devices will be listed in the order that the devices are found.

## 5 Wait until your Bluetooth device appears in the list.



- If you cannot find the Bluetooth device that you want to connect, check that the device is waiting for the Bluetooth wireless technology connection.

## 6 Touch the Bluetooth device name you want to register.

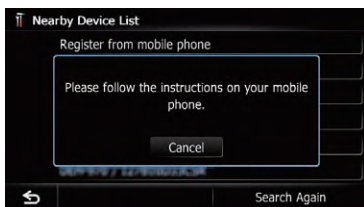

- If you touch **[Search Again]**, the system starts searching for Bluetooth devices waiting for connection, and displays them in the list format when any devices are detected.

## 7 Enter the password (the default password is "1111") using the Bluetooth device.

Enter the password while the message **"Please follow the instructions on your mobile phone."** appears.

The device is registered in the navigation system.

After the device is successfully registered, the Bluetooth connection is established from the navigation system.

## Pairing from your Bluetooth devices

You can register the Bluetooth device by setting the navigation system to standby mode and requesting connection from the Bluetooth device.

### 1 Activate the Bluetooth wireless technology on your devices.

For some Bluetooth devices, no specific action is necessary to activate Bluetooth wireless technology. For details, refer to the instruction manual of your devices.

### 2 Display the "Settings Menu" screen.

- ➔ For details of the operations, refer to *Screen switching overview* on page 26.

### 3 Touch [Bluetooth Settings].

The **"Bluetooth Settings"** screen appears.

### 4 Touch [Registration].

The **"Nearby Device List"** screen appears.

### 5 Touch [Register from mobile phone].

The navigation system waits for a Bluetooth wireless technology connection.

# Registering and connecting a Bluetooth device

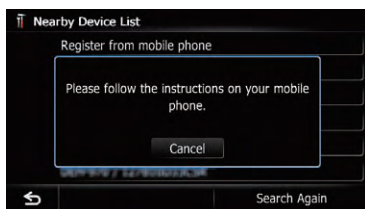

## 6 Register the navigation system on your Bluetooth device.

If your device asks you to enter a password, enter the password of the navigation system. When the device is successfully registered, the connection settings are made from the device.

- ❑ If registration fails, repeat the procedure from the beginning.

## Searching for a specified Bluetooth device

If you cannot connect your Bluetooth device using the nearby device search and if your Bluetooth device is found in the list, try the following method.

### 1 Activate the Bluetooth wireless technology on your devices.

For some Bluetooth devices, no specific action is necessary to activate Bluetooth wireless technology. For details, refer to the instruction manual of your devices.

### 2 Display the “Settings Menu” screen.

- ➡ For details of the operations, refer to *Screen switching overview* on page 26.

### 3 Touch [Bluetooth Settings].

The “Bluetooth Settings” screen appears.

### 4 Touch [Registration].

The “Nearby Device List” screen appears.

### 5 Touch [Select specific devices].

The “Select specific devices” screen appears.

## 6 Touch the Bluetooth device name to be connected.



The system searches for Bluetooth devices waiting for the connection and displays them in the list if a device is found.

- ❑ If you cannot find the desired device name on the list, touch **[Other phones]** to search the devices available nearby.

## 7 Wait until your Bluetooth device appears in the list.



- ❑ If you cannot find the Bluetooth device that you want to connect, check that the device is waiting for the Bluetooth wireless technology connection.

## 8 Touch the Bluetooth device name you want to register.

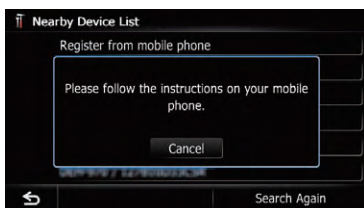

- If you touch **[Search Again]**, the system starts searching for Bluetooth devices waiting for connection, and displays them in the list format when any devices are detected.

## 9 Enter the password (the default password is "1111") using the Bluetooth device.

Enter the password while the message **"Please follow the instructions on your mobile phone."** appears.

The device is registered in the navigation system.

After the device is successfully registered, the Bluetooth connection is established from the navigation system.

## Deleting a registered device

When you have already registered 5 Bluetooth devices and you want to add another one, you must first delete one of the registered devices.

- If a registered phone is deleted, all the phone book entries and call history lists that correspond to the phone will be also cleared.

## 1 Display the "Settings Menu" screen.

- For details of the operations, refer to *Screen switching overview* on page 26.

## 2 Touch [Bluetooth Settings].

The **"Bluetooth Settings"** screen appears.

## 3 Touch [Registration].

A message prompting you to delete a registered device appears.

## 4 Touch [OK].



The **"Delete from Connection List"** screen appears.

## 5 Touch the Bluetooth device name that you want to delete.

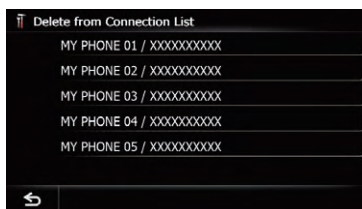

The device is deleted. □

## Connecting a registered Bluetooth device manually

The navigation system automatically connects the Bluetooth device selected as the target of connection. However, connect the Bluetooth device manually in the following cases:

- Two or more Bluetooth devices are registered, and you want to manually select the device to be used.
- You want to reconnect a disconnected Bluetooth device.

## Registering and connecting a Bluetooth device

- Connection cannot be established automatically for some reason.

If you start connection manually, carry out the following procedure. You can also connect the Bluetooth device by having the navigation system detect it automatically.

### 1 Activate the Bluetooth wireless technology on your devices.

For some Bluetooth devices, no specific action is necessary to activate Bluetooth wireless technology. For details, refer to the instruction manual of your devices.

### 2 Display the "Settings Menu" screen.

- ➔ For details of the operations, refer to *Screen switching overview* on page 26.

### 3 Touch [Bluetooth Settings].

The "Bluetooth Settings" screen appears.

### 4 Touch [Connection].

The "Connection List" screen appears.

### 5 Touch the name of the device that you want to connect.



The "Select Profile" screen appears.

### 6 Touch the profile that you want to connect.



You can select the following profiles:

- **Handsfree and Audio:**

Connects the device as the hands free phone and the Bluetooth audio player.

- **Audio:**  
Connects the device as Bluetooth audio player.
- **Handsfree:**  
Connects the device as the hands free phone.

Connection starts.



When a connection is successfully established, a connection complete message appears and the map screen returns by touching [OK].

- To cancel the connection to your device, touch [Cancel].
- If connection fails, check whether your device is waiting for a connection and then retry.

## Setting for priority connecting

The selected device is set for priority connecting.

And one of the following icons is indicated next to the device name.

- : Appears when the device is registered so that it will be preferentially paired with both the hands free and Bluetooth audio connection.
- : Appears when the device is registered so that it will be preferentially paired with the Bluetooth audio connection.
- : Appears when the device is registered so that it can be preferentially paired with the hands free connection.

## ⚠ CAUTION

For your safety, avoid talking on the phone as much as possible while driving.

If your cellular phone features Bluetooth technology, this navigation system can be connected to your cellular phone wirelessly. Using this hands free function, you can operate the navigation system to make or receive phone calls. You can also transfer the phone book data stored in your cellular phone to the navigation system. This section describes how to set up a Bluetooth connection and how to operate a cellular phone featuring Bluetooth technology on the navigation system.

For details about the connectivity with the devices featuring Bluetooth wireless technology, refer to the information on our website.

## Displaying the phone menu

Use the “Phone Menu” if you connect the cellular phone to the navigation system for utilization.

➡ For details, refer to Chapter 11.

**1 Press the HOME button to display the “Top Menu” screen.**

**2 Touch [Phone].**

The “Phone Menu” screen appears.

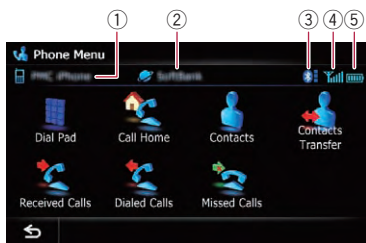

- ① Name of connected cellular phone
- ② Network name of the cellular phone company

- ③ Strength of the Bluetooth connection between the navigation system and the device
- ④ Reception status of the cellular phone
- ⑤ Battery status of the cellular phone

## Making a phone call

You can make a phone call in many different ways.

### Direct dialing

**1 Display the “Phone Menu” screen.**

- ➡ For details, refer to *Displaying the phone menu* on this page.

**2 Touch [Dial Pad].**

The “Dial Input” screen appears.

**3 Touch the number keys to enter the phone number.**



The phone number that was input is displayed.

When the input is complete, [OK] becomes active.

- If you touch , the entered number is deleted one digit at a time from the end of the number. Press and hold to delete all digits.
- If you touch , the previous screen returns.

**4 Touch [OK] to make a call.**

- To cancel the call after the system starts dialing, touch

**5 Touch to end the call.**



## Using hands-free phoning

### Making a call home easily

You can call home without taking the time to enter the phone number if the phone number has been registered.

#### 1 Display the “Phone Menu” screen.

- ➔ For details, refer to *Displaying the phone menu* on the previous page.

#### 2 Touch [Call Home].

Dialing home starts.

- If you have not registered your home number, a message appears. Touch [Register] to start registration.
- ➔ For details, refer to *Registering your home* on page 162.

### Calling a number in the phone book

You can select and call a contact from the phone book entries transferred to the navigation system.

- Before using this function, you need to transfer the phone book entries stored in your cellular phone to the navigation system.
- ➔ For details, refer to *Transferring the phone book* on page 68.

### Searching for a contact to call on the alphabet tabs

#### 1 Display the “Phone Menu” screen.

- ➔ For details, refer to *Displaying the phone menu* on the previous page.

#### 2 Touch [Contacts].

The “Contacts List” screen appears.

#### 3 Touch alphabet tabs.



The screen jumps to the top of the page displaying the entries that start with the selected letter or number.

- Touching [#ABCDE] displays all entries that start with symbols or numbers.
- Touching [Others] displays the page including entries that are not assigned to any of the other tabs.

#### 4 Touch the desired name on the list.

The “Contacts Type Selection” screen appears.

#### 5 Touch the desired entry on the list to make a call.

#### 6 Touch to end the call.

### Calling a number by searching by name

#### 1 Display the “Phone Menu” screen.

- ➔ For details, refer to *Displaying the phone menu* on the previous page.

#### 2 Touch [Contacts].

The “Contacts List” screen appears.

#### 3 Touch [Search].

The “Contacts Name Search” screen appears. You can search by the names registered in the “Contacts List” screen.

- 4 Enter the desired name and then touch [OK].

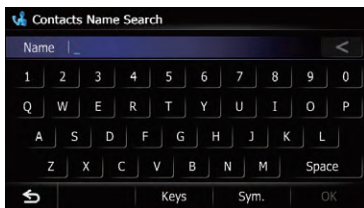

The “Contacts Name Search Results” screen appears.

- 5 Touch the desired name on the list.

The “Contacts Type Selection” screen appears.

- 6 Touch the desired entry on the list to make a call.

- 7 Touch  to end the call.

## Dialing from the history

The most recent calls made (dialed), received and missed are stored in the call history list. You can browse the call history list and call numbers from it.

- Each call history saves 30 calls per registered cellular phone. If the number of calls exceeds 30, the oldest entry will be deleted.

- 1 Display the “Phone Menu” screen.

- ➔ For details, refer to *Displaying the phone menu* on page 64.

- 2 Touch [Received Calls], [Dialed Calls] or [Missed Calls].

The selected call history list appears.

- 3 Touch an entry on the list.

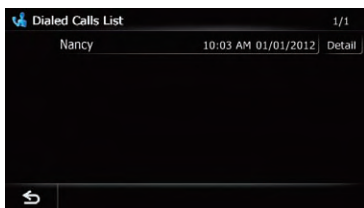

Dialing starts.

- To cancel the call after the system starts dialing, touch .
- If you touch [Detail], the “Detailed Information” screen appears.

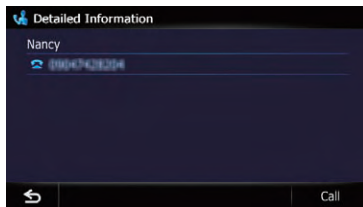

You can check the details of the party before making a phone call.

- 4 Touch  to end the call.

## Dialing a favorite location

You can make a call to an entry stored in the “Favorites” list.

- 1 Display the “Destination Menu” screen.

- ➔ For details of the operations, refer to *Screen switching overview* on page 26.

- 2 Touch [Favorites].

The “Favorites” screen appears.

- 3 Touch  next to the location that you want to make a call.

The “Edit Favorite” screen appears.

- 4 Touch [Call] to make a call.

- To cancel the call after the system starts dialing, touch .

- 5 Touch  to end the call.

## Dialing a facility’s phone number

You can make a call to facilities with phone number data.

- You cannot make a call to locations or POIs that have no phone number data.

- 1 Display the “Destination Menu” screen.

- ➔ For details of the operations, refer to *Screen switching overview* on page 26.

## Using hands-free phoning

### 2 Touch [POI].

The “POI Search” screen appears.

### 3 Search for the POI.

The “POI List” screen appears.

- ➔ For details of the operation, refer to *Search ing for Points of Interest (POI)* on page 40.

### 4 Touch next to the POI that you want to call.

The “POI Information” screen appears.

### 5 Touch [Call] to make a call.

- To cancel the call after the system starts dialing, touch .

### 6 Touch to end the call.

## Dialing from the map

You can make a call by selecting the icon of a registered location or a POI icon from the map screen.

- You cannot make a call to locations or POIs that have no phone number data.

### 1 Scroll the map, and place the cursor on an icon on the map.

### 2 Touch .

The “Information List” screen appears.

### 3 Touch the POI you want.

The “POI Information” screen appears.

### 4 Touch [Call] to make a call.

- To cancel the call after the system starts dialing, touch .

### 5 Touch to end the call.

## Receiving a phone call

You can perform hands free answering by using the navigation system.

## Answering an incoming call

The system informs you that it is receiving a call by displaying a message and producing a ring sound.

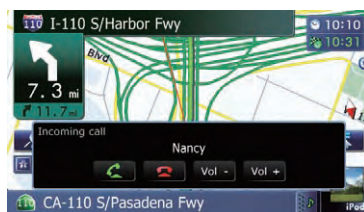

- You can set the system to automatically answer incoming calls. If not set to automatically answer incoming calls, you will have to answer the calls manually.
  - ➔ For details, refer to *Answering a call automatically* on page 70.
- If the voice on the other end of the call is too quiet to hear, you can adjust the volume of the received voice.
  - ➔ For details, refer to *Setting the Volume for Guidance and Phone* on page 172.
- The registered name appears if the phone number of the received call is already registered in “Contacts”.
- Depending on the caller ID service, the phone number of the received call may not be displayed. “Unknown” appears instead.

### 1 To answer an incoming call, touch .

The operation menu during a call appears.

- If you touch [Vol -] or [Vol +], you can adjust the ring tone volume.
- If you touch  an incoming call is rejected.

The rejected call is recorded in the missed call history list.

- ➔ For details, refer to *Dialing from the history* on the previous page.

## 2 Touch to end the call.

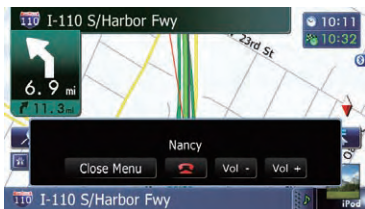

The call ends.

- ❑ You may hear a noise when you hang up the phone.
- If you touch **[Vol -]** or **[Vol +]**, you can adjust the volume when talking.
- If you touch **[Close Menu]**, the operation menu during call is minimized.

To display the menu again, touch .



## Transferring the phone book

You can transfer the phone book entries from your cellular phone to the phone book of the navigation system.

- ❑ Depending on the cellular phone, phone book may be called Contacts, Business Card or something else.
- ❑ With some cellular phones, it may not be possible to transfer the entire phone book at once. In this case, transfer addresses one at a time from your phone book using your cellular phone.
- ❑ If you connect the cellular phone featuring auto synchronization function, phone book transfer or synchronization will be automatically performed.

- ❑ A maximum of 1 000 entries can be transferred per cellular phone. If the entries exceed 1 000, the extra entries will not be transferred. If more than one number is registered for one person, such as work place and home, each number may be counted separately.
- ❑ Each entry can hold up to 5 phone numbers.
- ❑ Depending on the cellular phone that is connected to this navigation system via Bluetooth technology, this navigation system may not be able to display the phone book correctly. (Some characters may be garbled.)
- ❑ If the phone book in the cellular phone contains image data, the phone book may not be correctly transferred.
- ❑ The transferred data cannot be edited on the navigation system.

### 1 Connect the cellular phone that has the phone book to transfer.

- ➔ For details, refer to *Connecting a registered Bluetooth device manually* on page 62.

### 2 Touch **[Contacts Transfer]** on the "Phone Menu" screen.

### 3 Check that the following screen is displayed, and operate your cellular phone to transfer the phone book entries.

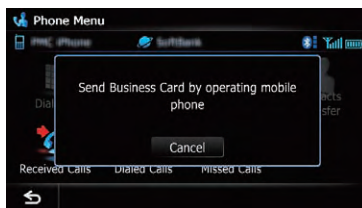

When data transfer is finished, a message asking whether you want to transfer more data appears.

Touch **[Yes]** to continue the transfer.

## Using hands-free phoning

### 4 Touch [No].

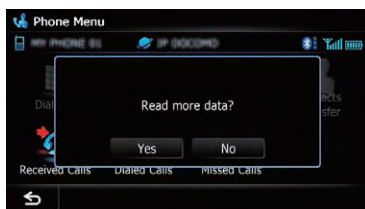

The transferred data is imported to the navigation system.

When the data is successfully imported, an import complete message is displayed and the “Contacts List” screen appears.

- It may take time depending on how many entries will be transferred.

## Changing the order of names in the phone book

### 1 Display the “Settings Menu” screen.

- ➔ For details of the operations, refer to *Screen switching overview* on page 26.

### 2 Touch [Bluetooth Settings].

The “Bluetooth Settings” screen appears.

### 3 Touch [Sort Order].

Each touch of [Sort Order] changes the settings as follows:

- **First** (default):  
Switches the contacts entries to first/last name display and sort the entries by order of first name.
  - **Last**:  
Switches the contacts entries to last/first name display and sort the entries by order of last name.
- Depending on the type of cellular phone, the settings may not be available.

## Deleting registered contacts

### 1 Display the “Phone Menu” screen.

- ➔ For details, refer to *Displaying the phone menu* on page 64.

### 2 Touch [Contacts].

The “Contacts List” screen appears.

### 3 Touch [Delete].

The “Delete from Contacts” screen appears.

### 4 Touch the entry you want to delete.

A check mark appears next to the entry.

- If you touch [All], you can select all entries. If you want to deselect all entries, touch [None].

### 5 Touch [Delete].

The message confirming whether to delete the entry appears.

### 6 Touch [Yes].

The entry is deleted.

- If you touch [No], the deletion is canceled. □

## Changing the phone settings

### Editing the device name

You can change the device name to be displayed on your cellular phone. (Default is “PIONEER NAVI”.)

### 1 Display the “Settings Menu” screen.

- ➔ For details of the operations, refer to *Screen switching overview* on page 26.

### 2 Touch [Bluetooth Settings].

The “Bluetooth Settings” screen appears.

### 3 Touch [Device Name].

The keyboard to enter the name appears.

### 4 Touch to delete the current name, and enter the new name by using the keyboard.



- ❑ Up to 16 characters can be entered for a device name.

### 5 Touch [OK].

The name is changed.

## Editing the password

You can change the password to be used for authentication on your cellular phone. (Default is "1111".)

- ❑ Four to eight characters can be entered for a password.

### 1 Display the "Settings Menu" screen.

- ➔ For details of the operations, refer to *Screen switching overview* on page 26.

### 2 Touch [Bluetooth Settings].

The "Bluetooth Settings" screen appears.

### 3 Touch [Password].

The "Set Password" screen appears.

### 4 Touch to delete the current password, and enter the new password by using the keyboard.

### 5 Touch [OK].

The password is changed.

## Stopping Bluetooth wave transmission

You can stop transmission of electric waves by turning off the Bluetooth function. If you do not use the Bluetooth wireless technology, we recommend selecting "Off".

### 1 Display the "Settings Menu" screen.

- ➔ For details of the operations, refer to *Screen switching overview* on page 26.

### 2 Touch [Bluetooth Settings].

The "Bluetooth Settings" screen appears.

### 3 Touch [Bluetooth On/Off].

Each touch of [Bluetooth On/Off] changes the settings as follows:

- **On** (default):  
Turns on Bluetooth function.
- **Off**:  
Turns off Bluetooth function.

## Echo canceling and noise reduction

When you are operating hands free phoning in the vehicle, you may hear an undesirable echo. This function reduces the echo and noise while you are using hands free phoning, and maintains a certain sound quality.

### 1 Display the "Settings Menu" screen.

- ➔ For details of the operations, refer to *Screen switching overview* on page 26.

### 2 Touch [Bluetooth Settings].

The "Bluetooth Settings" screen appears.

### 3 Touch [Echo Cancel].

Each touch of [Echo Cancel] changes the settings as follows:

- **On** (default):  
Activates echo canceling and noise reduction.
- **Off**:  
Deactivates echo canceling and noise reduction.

## Answering a call automatically

The navigation system automatically answers incoming calls to the cellular phone, so you can answer a call while driving without taking your hands off the steering wheel.

### 1 Display the "Settings Menu" screen.

- ➔ For details of the operations, refer to *Screen switching overview* on page 26.

### 2 Touch [Bluetooth Settings].

The "Bluetooth Settings" screen appears.

### 3 Touch [Auto Answer Preference].

The "Auto Answer Preference" screen appears.

## Using hands-free phoning

### 4 Touch the desired option.

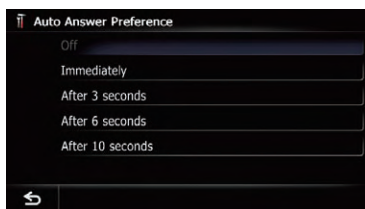

On this screen, you can select the following items:

- **Off** (default):  
No automatic response. Respond manually.
- **Immediately**:  
Answers immediately.
- **After 3 seconds**:  
Answers after three seconds.
- **After 6 seconds**:  
Answers after six seconds.
- **After 10 seconds**:  
Answers after ten seconds.

## Setting the automatic rejection function

If this function is on, the navigation system automatically rejects all incoming calls.

### 1 Display the “Settings Menu” screen.

- For details of the operations, refer to *Screen switching overview* on page 26.

### 2 Touch [Bluetooth Settings].

The “**Bluetooth Settings**” screen appears.

### 3 Touch [Refuse All Calls].

Each touch of [**Refuse All Calls**] changes the settings as follows:

- **Off** (default):  
Accepts all incoming calls.
  - **On**:  
Rejects all incoming calls.
- If both “**Refuse All Calls**” and “**Auto Answer Preference**” are activated, “**Refuse All Calls**” takes priority and all incoming calls are automatically rejected.

- If “**Refuse All Calls**” is set to “**On**”, rejected incoming calls will not be stored in the missed call list.

## Clearing memory

You can clear the memory of each item that corresponds to the connected cellular phone: phone book, dialed/received/missed call history list and preset dials.

### 1 Display the “Settings Menu” screen.

- For details of the operations, refer to *Screen switching overview* on page 26.

### 2 Touch [Bluetooth Settings].

The “**Bluetooth Settings**” screen appears.

### 3 Touch [Clear Memory].

The “**Clear Memory**” screen appears.

### 4 Touch the desired option.

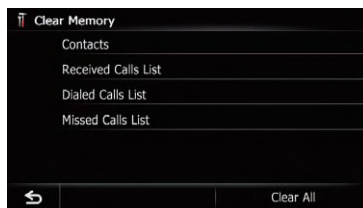

On this screen, you can select the following items:

- **Contacts**:  
Clears the registered phone book.
  - **Received Calls List**:  
Clears the received call history list.
  - **Dialed Calls List**:  
Clears the dialed call history list.
  - **Missed Calls List**:  
Clears the missed call history list.
- If you touch [**Clear All**], all the data is cleared that correspond to the connected cellular phone.

### 5 Touch [Yes].

Data on the selected item is cleared from this navigation system’s memory.

- If you do not want to clear the memory that you have selected, touch [**No**].

## Updating the Bluetooth wireless technology software

Update files will be available for download in the future. You will be able to download the latest update from an appropriate website to your PC.

- ❑ Before you download the files and install the update, read through the instructions on the website. Follow the instructions on the website for steps until [**Firmware update**] becomes active.

**1 Store the updated files into the SD memory card.**

**2 Insert an SD memory card into the SD card slot.**

- ➔ For details of the operation, refer to *Inserting and ejecting an SD memory card* on page 18.

**3 Display the “Settings Menu” screen.**

- ➔ For details of the operations, refer to *Screen switching overview* on page 26.

**4 Touch [Bluetooth Settings].**

The “Bluetooth Settings” screen appears.

**5 Touch [Firmware update].**

The current version is displayed.



**6 Touch [Firmware update].**

The message confirming whether or not to start the update will appear.

**7 Touch [Yes].**

Update starts.

**8 Wait until the upgrade process is complete.**

A message will appear after the update is complete.

**9 Touch [OK].**

The message disappears, and the map screen returns.

**10 Eject the SD memory card.** ❑

## Notes for hands-free phoning

### General notes

- Connection to all cellular phones featuring Bluetooth wireless technology is not guaranteed.
- The line of sight distance between this navigation system and your cellular phone must be 10 meters or less when sending and receiving voice and data via Bluetooth technology. However, the actual transmission distance may be shorter than the estimated distance, depending on the usage environment.
- With some cellular phones, the ring sound may not be output from the speakers.
- If private mode is selected on the cellular phone, hands free phoning may be disabled.

### Registration and connection

- Cellular phone operations vary depending on the type of cellular phone. Refer to the instruction manual that came with your cellular phone for detailed instructions.
- With cellular phones, phone book transfer may not work even though your phone is paired with the navigation system. In that case, disconnect your phone, perform pairing again from your phone to the navigation system, and then perform the phone book transfer.

### Making and receiving calls

- You may hear a noise in the following situations:



## Using hands-free phoning

When you answer the phone by using the button on the phone.

When the person on the other end of line hangs up the phone.

- If the person on the other end of the phone call cannot hear the conversation due to an echo, decrease the volume level for hands free phoning. This may reduce the echo.
- With some cellular phones, even if you press the accept button on the cellular phone when a call comes in, hands free phoning may not be performed.
- The registered name appears if the phone number of the received call is already registered in the phone book. When one phone number is registered under different names, the name that comes first in the phone book is displayed.
- If the phone number of the received call is not registered in the phone book, the phone number of the received call appears.

### The received call history and the dialed number history

- Calls made or editing performed only on your cellular phone will not be reflected to the dialed number history or phone book in the navigation system.
- You cannot make a call to the entry of an unknown user (no phone number) in the received call history.
- If calls are made by operating your cellular phone, no history data will be recorded in the navigation system.

### Phone book transfers

- If there are more than 1 000 phone book entries on your cellular phone, all entries may not be downloaded completely.
- With some cellular phones, it may not be possible to transfer all items in the phone book at one time. In this case, transfer items one by one from your cellular phone.
- Depending on the cellular phone, this navigation system may not display the phone book correctly. (Some characters may be

garbled, or first and last names may be reversed.)

- If the phone book in the cellular phone contains image data, the phone book may not be transferred correctly. (Image data can not be transferred from the cellular phone.)
- Depending on the cellular phone, phone book transfer may not be available. 

This chapter describes the basic operations of the AV source.

You can play or use the following sources with your Pioneer navigation system.

- Tuner (HD Radio™ tuner) (\*1)
- FM (\*2)
- AM (\*2)
- CD
- ROM (in MP3, AAC, WMA)
- DVD Video
- DivX
- USB
- SD

The following sources can be played back or used by connecting an auxiliary device.

- HD Radio (HD Radio™ tuner) (\*2)
- iPod
- Smartphone application (Pandora, Aha Radio)
- Bluetooth audio
- XM Tuner
- SIRIUS Tuner
- AV input 1 (AV1)
- AV input 2 (AV2)
- External unit 1 (EXT1)
- External unit 2 (EXT2)
- (\*1) A source available only on AVIC Z140BH.
- (\*2) Sources available on AVIC X940BT.

## Displaying the AV operation screen

- Press the **MODE** button when the map screen is displayed.
  - The AV operation screen can also be displayed by touching **[AV Source & Contents]** on the "Top Menu".

## Selecting a source

Source icons

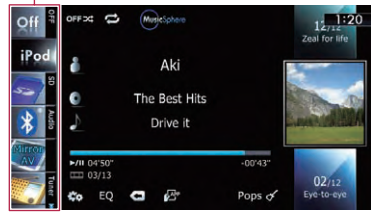

### 1 Touch, then drag any source icons up or down to display additional source icons.

The AV source icons will scroll, and previously hidden icons will appear.

### 2 Tap the icon of the source you want to select.

The operation screen of the selected source appears.

- The currently selected source icon is high lighted.

## Operating list screens (e.g. iPod list screen)

This describes the operations when a list screen is displayed.

- For information on how to display the list screen, refer to the descriptions within the desired source portion of this manual.

## Switching between the AV operation screen and the list screen

The following example describes how to switch between the AV operation screen and the artist list screen of iPod.

## Basic operations of the AV source

- 1 Touch the appropriate key to display the list that you want.



- 2 Touch the key on the right edge of the screen.

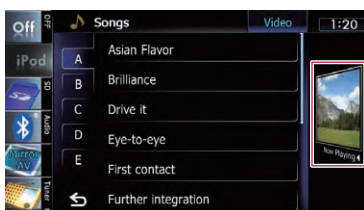

The AV operation screen returns.

### Selecting an item

- 1 Scroll the list by dragging items up or down to display the item you want to select.



- Flicking a list item enables you to quickly scroll through the list.  
To stop scrolling, gently touch the list.

- 2 Tap the item.

- The item currently selected is highlighted.

### Returning to the previous display

- Touch  to return to the previous screen. 

## Using the radio (FM)

- ❑ This function is available for AVIC X940BT only.

You can listen to the radio by using the navigation system. This section describes operations for radio (FM).

### Starting procedure

#### 1 Display the AV operation screen.

- ➔ For details of the operations, refer to *Dis playing the AV operation screen* on page 74.

#### 2 Tap [FM] on the left edge of the screen to display the "FM" screen.

When the tuner has been tuned in to an HD Radio broadcasting, [FM] cannot be selected.

#### 3 Use the touch panel keys on the screen to control the radio.

- ➔ For details, refer to *Using the touch panel keys* on the next page.

Shows that the frequency selected is being broadcast in stereo.

#### ⑦ **Current time**

#### ⑧ **Program service name or frequency indicator**

Shows the frequency of the preset item. If the program service name can be obtained, the program service name is shown instead of the frequency.

#### ⑨ **Preset number indicator**

Shows what preset item has been selected.

### Reading the screen

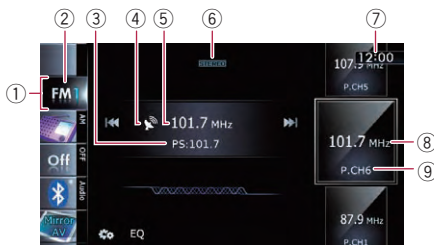

#### ① **Source icon**

Shows which source has been selected.

#### ② **Band indicator**

Shows which band the radio is tuned to: FM1 to FM3.

#### ③ **Program service name indicator**

Shows the program service name (station name) of the current station.

#### ④ **Signal level indicator**

#### ⑤ **Frequency indicator**

#### ⑥ **STEREO indicator**

## Using the radio (FM)

### Using the touch panel keys

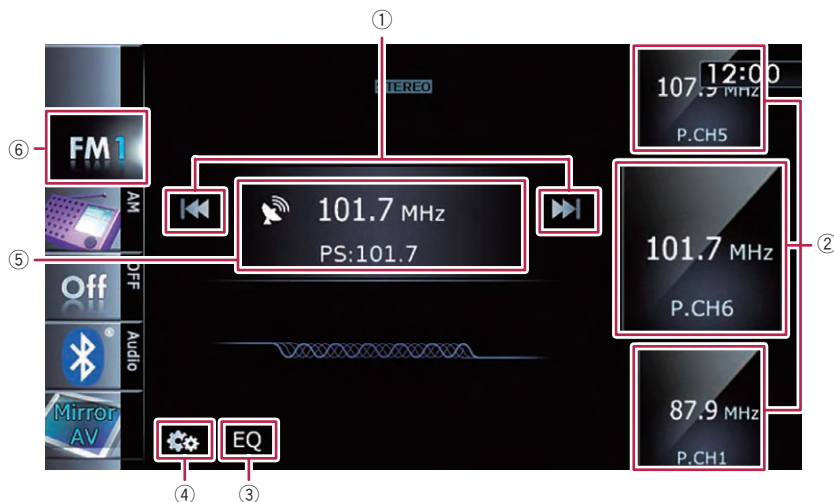

#### ① Performs manual tuning

To tune manually, touch [◀◀] or [▶▶] briefly. The frequencies move up or down one step at a time.

#### Performs seek tuning

To perform seek tuning, touch and hold [◀◀] or [▶▶] for about one second and then release. The tuner will scan frequencies until a broadcast strong enough for good reception is found.

- ❑ You can cancel seek tuning by touching either [◀◀] or [▶▶] briefly.
- ❑ If you keep holding [◀◀] or [▶▶], you can skip broadcasting frequencies. Seek tuning will start at the time you release the keys.

#### ② Selects a preset channel

The keys can be used to switch preset channels.

Scroll by dragging the keys up or down to display the preset channel you want to select, and tap the channel.

- ❑ The lower keys and the upper keys appear only when the preset channel is selected.

#### ③ Recalls equalizer curves

➤ For details, refer to *Using the equalizer* on page 182.

#### ④ Displays the “Function” menu

➤ For details, refer to *Using advanced functions* on the next page.

#### ⑤ Switches between the AV operation screen and the preset list display

You can switch the screen display according to your preference.

➤ For details of the operation, refer to ***Switching between the AV operation screen and the list screen*** on page 74.

#### ⑥ Selects an FM band

Tapping the key repeatedly switches between the following FM bands: **FM1**, **FM2**, or **FM3**.

- ❑ This function is convenient for preparing different preset lists for each band.

### Storing and recalling broadcast frequencies

With a tap of any of the preset tuning keys (“P1” to “P6”), you can easily store up to six broadcast frequencies for later recall (also with the tap of a key).

- 1 Select a frequency that you want to store in memory.
- 2 Display the preset channel list.
  - For details, refer to **Switches between the AV operation screen and the preset list display** on the previous page.
- 3 Keep touching a preset tuning key [P1] to [P6].

Preset list display



Preset tuning keys

The selected radio station has been stored in memory.

The next time you tap the same preset tuning key “P1” to “P6”, the radio station frequencies are recalled from memory.

- ❑ Up to 18 FM stations, six for each of the three FM bands can be stored in memory.
- For details of the list operations, refer to *Operating list screens (e.g. iPod list screen)* on page 74. ❑

## Operating by hardware buttons

### Pressing the TRK button

You can move preset channels up or down.

### Pressing and holding the TRK button

You can perform seek tuning. ❑

## Using advanced functions

- Touch  on the “FM” screen.

The “Function” menu appears.

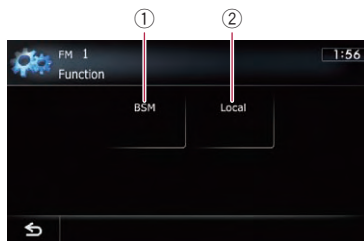

- ① Stores the strongest broadcast frequencies
  - ② Tunes in strong signals
- For details of each function, refer to sections below with the relative titles.

## Storing the strongest broadcast frequencies

BSM (best stations memory) lets you automatically store the six strongest broadcast frequencies under the preset tuning keys “P1” to “P6” and, once stored there, you can tune into them with the touch of a key.

- ❑ Storing broadcast frequencies with BSM may replace broadcast frequencies you have already saved.

### 1 Touch on the “FM” screen.

The “Function” menu appears.

### 2 Touch [BSM].

### 3 Touch [Start] to begin a search.

“BSM” begins to flash. While “BSM” is flashing, the six strongest broadcast frequencies will be stored under the preset tuning keys “P1” to “P6” in order of their signal strength. When this is complete, “BSM” stops flashing.

- If you touch [Stop], the storage process is canceled.

## Tuning in strong signals

Local seek tuning allows you to tune in only those radio stations with sufficiently strong signals for good reception.

## Using the radio (FM)

### 1 Touch on the "FM" screen.

The "Function" menu appears.

### 2 Touch [Local].

### 3 Touch [On] to turn local seek tuning on.

- If you touch [Off], local seek tuning is turned off.

### 4 Touch [◀Prev] or [Next▶] to set the sensitivity.

There are four levels of sensitivity for FM.

Level: **1** **2** **3** **4**

- The level "4" setting allows reception of only the strongest stations, while lower settings let you receive weaker stations. □

- ❑ This function is available for AVIC X940BT only.

You can listen to the radio using this navigation system. This section describes operations for radio (AM).

## Starting procedure

### 1 Display the AV operation screen.

- ➡ For details of the operations, refer to *Dis playing the AV operation screen* on page 74.

### 2 Tap [AM] on the left edge of the screen to display the "AM" screen.

When the tuner has been tuned in to an HD Radio broadcasting, [AM] cannot be selected.

### 3 Use the touch panel keys on the screen to control the radio.

- ➡ For details, refer to *Using the touch panel keys* on the next page. ❑

## Reading the screen

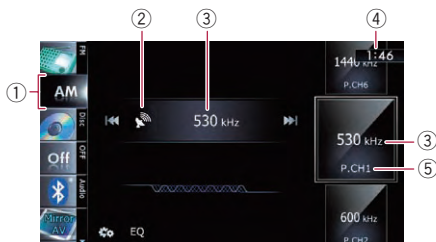

- ① **Source icon**  
Shows which source has been selected.
- ② **Signal level indicator**
- ③ **Frequency indicator**  
Shows the current frequency.
- ④ **Current time**
- ⑤ **Preset number indicator**  
Shows what preset item has been selected. ❑



## Using the radio (AM)

### Using the touch panel keys

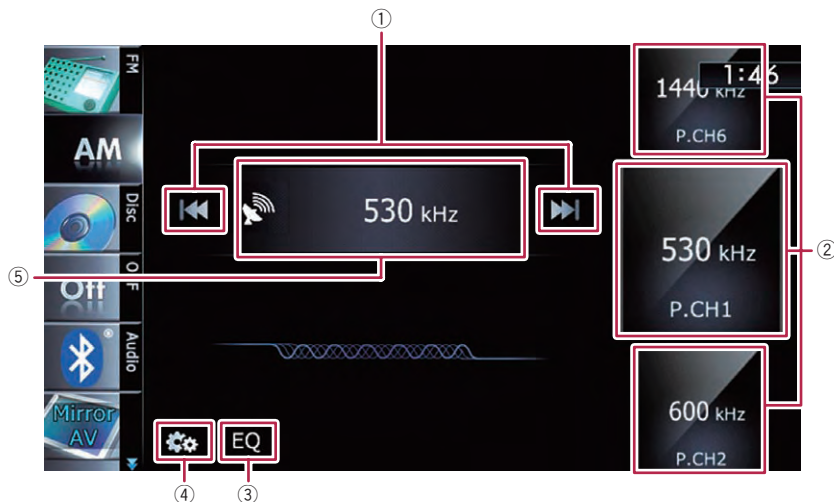

#### ① Performs manual tuning

To tune manually, touch [◀◀] or [▶▶] briefly. The frequencies move up or down one step at a time.

#### Performs seek tuning

To perform seek tuning, touch and hold [◀◀] or [▶▶] for about one second and then release. The tuner will scan frequencies until a broadcast strong enough for good reception is found.

- You can cancel seek tuning by touching either [◀◀] or [▶▶] briefly.
- If you keep holding [◀◀] or [▶▶], you can skip broadcasting frequencies. Seek tuning will start at the time you release the keys.

#### ② Selects a preset channel

The keys can be used to switch preset channels. Scroll by dragging the keys up or down to display the preset channel you want to select, and tap the channel.

- The lower keys and the upper keys appear only when the preset channel is selected.

#### ③ Recalls equalizer curves

➤ For details, refer to *Using the equalizer* on page 182.

#### ④ Displays the “Function” menu

➤ For details, refer to *Using advanced functions* on the next page.

#### ⑤ Switches between the AV operation screen and the preset list display

You can switch the screen display according to your preference.

➤ For details of the operation, refer to ***Switching between the AV operation screen and the list screen*** on page 74.

### Storing and recalling broadcast frequencies

With a tap of any of the preset tuning keys (“P1” to “P6”), you can easily store up to six broadcast frequencies for later recall (also with the tap of a key).

#### 1 Select a frequency that you want to store in memory.

## Using the radio (AM)

### 2 Display the preset channel list.

- For details, refer to **Switches between the AV operation screen and the preset list display** on the previous page.

### 3 Keep touching a preset tuning key [P1] to [P6].

Preset list display

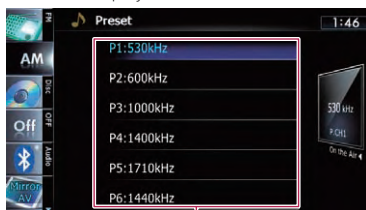

Preset tuning keys

The selected radio station has been stored in memory.

The next time you tap the same preset tuning key "P1" to "P6", the radio station frequencies are recalled from memory.

- For details of the list operations, refer to **Operating list screens (e.g. iPod list screen)** on page 74.

## Operating by hardware buttons

### Pressing the TRK button

You can move preset channels up or down.

### Pressing and holding the TRK button

You can perform seek tuning.

## Using advanced functions

- Touch on the "AM" screen.

The "Function" menu appears.

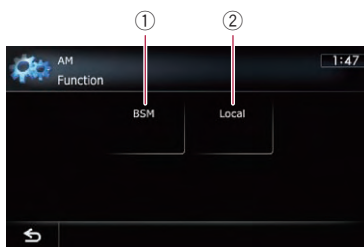

- ① **Stores the strongest broadcast frequencies**
  - ② **Tunes in strong signals**
- For details of each function, refer to sections below with the relative titles.

## Storing the strongest broadcast frequencies

BSM (best stations memory) lets you automatically store the six strongest broadcast frequencies under the preset tuning keys "P1" to "P6" and, once stored there, you can tune into them with the touch of a key.

- Storing broadcast frequencies with BSM may replace broadcast frequencies you have already saved.

### 1 Touch on the "AM" screen.

The "Function" menu appears.

### 2 Touch [BSM].

### 3 Touch [Start] to begin a search.

"BSM" begins to flash. While "BSM" is flashing, the six strongest broadcast frequencies will be stored under the preset tuning keys "P1" to "P6" in order of their signal strength. When this is complete, "BSM" stops flashing.

- If you touch [Stop], the storage process is canceled.

## Tuning in strong signals

Local seek tuning allows you to tune in only those radio stations with sufficiently strong signals for good reception.

## Using the radio (AM)

### 1 Touch on the "AM" screen.

The "Function" menu appears.

### 2 Touch [Local].

### 3 Touch [On] to turn local seek tuning on.

- If you touch [Off], local seek tuning is turned off.

### 4 Touch [◀Prev] or [Next▶] to set the sensitivity.

There are two levels of sensitivity for AM.

Level: **1** **2**

- The level "2" setting allows reception of only the strongest stations, while lower settings let you receive weaker stations. □

You can listen to the radio by using the navigation system. This section describes operations for HD Radio reception.

#### For AVIC-X940BT users

This navigation system is ready to receive HD Radio broadcasts when connected to the GEX P20HD, GEX P10HD, sold separately.

- For details concerning operation, refer to the HD Radio tuner's operation manual.
- AVIC Z140BH shows "Tuner" and AVIC X940BT shows "HD Radio" as the source icon. This chapter describes operation procedures for AVIC Z140BH.

## HD Radio broadcasting

HD Radio broadcasting is high quality audio and data services. HD Radio broadcasting is brought to you by your local FM or AM stations.

HD Radio broadcasting features the following:

- High quality audio
- FM multicasting
- Data services

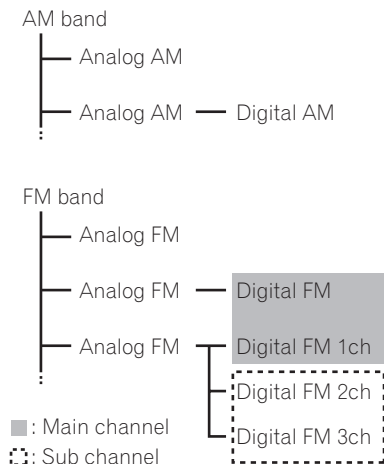

### Digital Sound

Digital, CD quality sound. HD Radio Technology enables local radio stations to broadcast a clean digital signal. AM sounds like today's FM and FM sounds like a CD.

### PSD

Program Service Data: Contributes to the superior user experience of HD Radio Technology. Presents song name, artist, station IDs, HD2/HD3 Channel Guide, and other relevant data streams.

### HD2/HD3

Adjacent to traditional main stations are extra local FM channels. These HD2/HD3 Channels provide new, original music as well as deep cuts into traditional genre.

### iTunes® Tagging

iTunes® Tagging provides you the opportunity to discover a wide range of content and the means to "tag" that content for later review and purchase from the iTunes® Store.

### Artist Experience

Visual information related to content being played on your HD Radio receiver, such as Album Art, historical photographs, still art from live broadcasts, among other related content.

## Starting procedure

### 1 Display the AV operation screen.

- For details of the operations, refer to *Displaying the AV operation screen* on page 74.

### 2 Tap [Tuner] on the left edge of the screen to display the "Tuner" screen.

### 3 Use the touch panel keys on the screen to control the radio.

- For details, refer to *Using the touch panel keys* on page 86. ■

# HD Radio™ reception

## Reading the screen

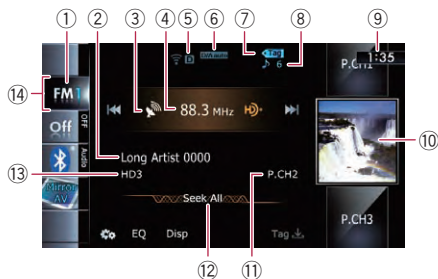

- ☐ Items marked with asterisk (\*) appear only on AVIC Z140BH.

① **Band indicator**

Shows which band the radio is tuned to: FM1, FM2, FM3 or AM.

② **Detailed information**

➔ For details, refer to *Switching the display* on page 87.

③ **Signal level indicator**

④ **Frequency indicator**

⑤ **Signal type indicator**

Shows the type of signal currently being received. If a digital broadcasting is received, "D" appears. Otherwise, "A" appears.

⑥ **Blending mode indicator**

➔ For details, refer to *Switching the reception mode* on page 89.

⑦ **Song info reception indicator\***

Shows the reception status of song information.

Indicator	Meaning
	Appears when the navigation system receives song information and can store it. The icon is displayed on the operation screen of the HD Radio receiver.
	Appears when the navigation system is storing song information. The icon is displayed on all operation screens of AV sources.

⑧ **Song info status indicator\***

Shows the status of the song information stored in the navigation system.

Indicator	Meaning
	The number of song information items stored in the navigation system is displayed. The icon is displayed on all operation screens of AV sources.
	Appears when song information is transferred to iPod. The icon is displayed on all operation screens of AV sources.

⑨ **Current time**

⑩ **Album artwork**

Shows the album artwork of the current song if it is available.

- ☐ If the album artwork cannot be acquired, the station logo is displayed. When the station logo cannot be acquired either, the preset number indicator is displayed.
- ☐ The AVIC X940BT shows the preset number indicator only.

⑪ **Preset number indicator**

➔ Shows what preset item has been selected.

⑫ **Seek type indicator**

➔ For details, refer to *Switching the seek mode* on page 89.

⑬ **Multicasting indicator**

Shows the number of multicast channels in the current frequency.

⑭ **Source icon**

Shows which source has been selected. ☐

## Using the touch panel keys

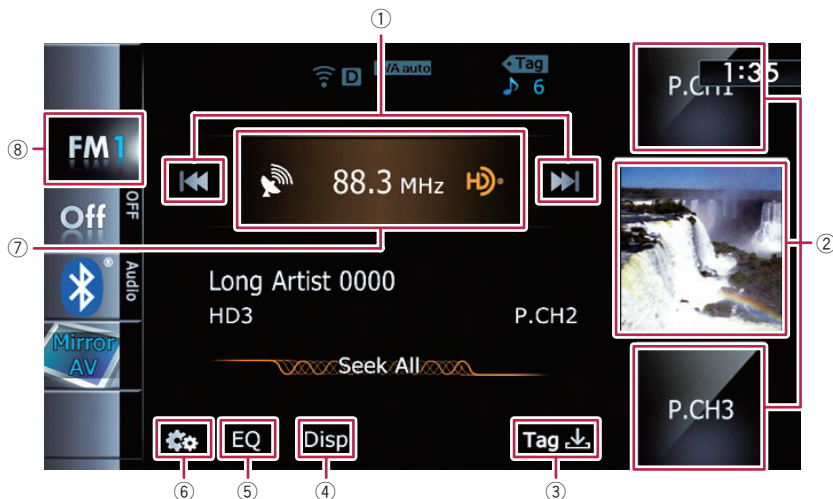

- ❑ Items marked with asterisk (\*) appear only on AVIC Z140BH.

### ① Performs manual tuning

To tune manually, touch [◀◀] or [▶▶] briefly. The frequencies move up or down one step at a time.

#### Performs seek tuning

To perform seek tuning, touch and hold [◀◀] or [▶▶] for about one second and then release. The tuner will scan frequencies until a broadcast strong enough for good reception is found.

- ❑ You can cancel seek tuning by touching either [◀◀] or [▶▶] briefly.
- ❑ When an analog station is received, tuning up or down is conducted within analog broadcasts.

If a digital broadcast is not yet received, tuning up or down tunes into the next or previous analog station.

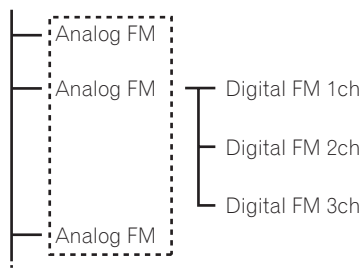

### ② Selects a preset channel

The keys can be used to switch preset channels.

Scroll by dragging the keys up or down to display the preset channel you want to select, and tap the channel.

- ❑ The lower keys and the upper keys appear only when the preset channel is selected.

### ③ Stores song information to an iPod\*

## HD Radio™ reception

Touch this key when receiving the song information of the song on air, and you can store the song information on your iPod.

➔ For details, refer to *Storing song information to an iPod (iTunes Tagging)* on the next page.

### ④ Switches the display

➔ For details, refer to *Switching the display* on this page.

### ⑤ Recalls equalizer curves

➔ For details, refer to *Using the equalizer* on page 182.

### ⑥ Displays the “Function” menu

➔ For details, refer to *Using advanced functions* on the next page.

### ⑦ Switches between the AV operation screen and the preset list display

You can switch the screen display according to your preference.

➔ For details of the operation, refer to *Switching between the AV operation screen and the list screen* on page 74.

### ⑧ Selects a band

Tap the key repeatedly until the desired band is displayed: **FM1**, **FM2**, **FM3**, or **AM**.

□ This function is convenient for preparing different preset lists for each band.

## Storing and recalling broadcast frequencies

With a tap of any of the preset tuning keys (“Preset 1” to “Preset 6”), you can easily store up to six broadcast frequencies for later recall (also with the tap of a key).

### 1 Select a frequency that you want to store in memory.

### 2 Display the preset channel list.

➔ For details, refer to *Switches between the AV operation screen and the preset list display* on this page.

### 3 Keep touching a preset tuning key [Preset 1] to [Preset 6].

Preset list display

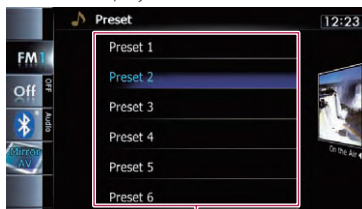

Preset tuning keys

The selected radio station has been stored in memory.

The next time you tap the same preset tuning key “Preset 1” to “Preset 6”, the radio station frequencies are recalled from memory.

□ Up to 18 FM stations, six for each of the three FM bands, as well as six AM stations, can be stored in memory.

➔ For details, refer to *Operating list screens (e.g. iPod list screen)* on page 74. □

## Operating by hardware buttons

### Pressing the TRK button

You can move preset channels up or down.

### Pressing and holding the TRK button

You can perform seek tuning. □

## Switching the display

Desired information can be displayed.

### ● Touch [Disp].

#### AVIC-Z140BH

Touching [Disp] repeatedly switches between the following settings:

Channel name    Artist name    Song title  
Genre

#### AVIC-X940BT

The contents and order of the setting display depend on the HD Radio tuner.

- ❑ Only when the tuner has been tuned in to an HD Radio station, can the display be changed.
- ❑ When the tuner has been tuned in to an HD Radio station, default display is changed into station name instead of frequency.

## Scrolling the detailed information

You can turn the detailed information scroll mode on and off.

- **Touch and hold [Disp].** 

## Storing song information to an iPod (iTunes Tagging)

- ❑ This function is available for AVIC Z140BH only.

You can store the song information to the iPod, when the navigation system has received the song information. The songs will show up in a playlist called "Tagged playlist" in iTunes next time you sync your iPod. You can directly buy the songs via the navigation system.

Depending on when the song information is stored, information on the songs before and after the song on air may also be stored. Be sure to confirm the song before you purchase.

- ❑ The iTunes Tagging function is available during reception of digital broadcasts.
- ❑ This function can be operated with the following iPod models:
  - iPod touch 4th generation
  - iPod touch 3rd generation
  - iPod touch 2nd generation
  - iPod touch 1st generation
  - iPod classic
  - iPod nano 6th generation
  - iPod nano 5th generation
  - iPod nano 4th generation
  - iPod nano 3rd generation
  - iPhone 4S
  - iPhone 4
  - iPhone 3GS
  - iPhone 3G

- iPhone

- ❑ The version of iTunes must be 7.4 or higher.

### 1 Tune into the digital broadcast station.



When song information is received,  is displayed while the desired song is being broadcast, and **[Tag]** becomes active.

- ➔ For details, refer to **Song info reception indicator\*** on page 85.

### 2 Touch [Tag].

The information on the song on air is stored in the navigation system.



While the information is being acquired,  is displayed.

When completed,  turns off and  is displayed.

- ❑ The song information for up to 50 songs can be stored on this navigation system. Depending on when the song information is stored, information for the previous song or song after the current song may also be stored.

### 3 Connect your iPod.

The song information stored in the navigation system is transferred to your iPod.

- ❑ If the iPod is already connected, every time you touch **[Tag]**, the song information will be transferred to your iPod. When the song information is stored on your iPod,  disappears.
- ❑ When transfer of song information is completed, the information stored in the navigation system will be automatically cleared.
- ❑ If you turn off the navigation system or disconnect the iPod while transferring song information to it, the transfer may not complete.
- ❑ While the song information is stored in the navigation system, transfer to iPod is not possible. 

## Using advanced functions

- **Touch  on the "Tuner" screen.**

The **"Function"** menu appears.



# HD Radio™ reception



- ① Stores the strongest broadcast frequencies
  - ② Switches the seek mode
  - ③ Tunes in strong signals
  - ④ Switches the reception mode
- For details of each function, refer to sections below with the relative titles.

## Storing the strongest broadcast frequencies

BSM (best stations memory) lets you automatically store the six strongest broadcast frequencies under the preset tuning keys "Preset 1" to "Preset 6" and, once stored there, you can tune in to these frequencies with the touch of a key.

1 Touch  on the "Tuner" screen.

2 Touch [BSM].

3 Touch [Start] to begin a search.

"BSM" begins to flash. While "BSM" is flashing, the six strongest broadcast frequencies will be stored under the preset tuning keys "Preset 1" to "Preset 6" in order of their signal strength. When this is complete, "BSM" stops flashing.

- To cancel the storage process, touch [Stop].
- Storing broadcast frequencies with BSM may replace broadcast frequencies you have already saved.

## Switching the seek mode

You can select the method of seek tuning.

1 Touch  on the "Tuner" screen.

2 Touch [Seek] to select the desired setting.

- **All:**  
Seeks stations from both analog and digital broadcasting.
- **HD:**  
Seeks from digital broadcasting only.
- If you select "HD" on this setting while [Blending] is set to "Analog", the setting on [Blending] turns to "D/A Auto" automatically.

## Tuning in strong signals

Local seek tuning allows you to tune in only those radio stations with sufficiently strong signals for good reception.

1 Touch  on the "Tuner" screen.

2 Touch [Local].

3 Touch [On] to turn local seek tuning on. To turn local seek tuning off, touch [Off].

4 Touch [◀Prev] or [Next▶] to set the sensitivity.

There are four levels of sensitivity for FM and two levels for AM:

FM: 1 2 3 4

AM: 1 2

- The FM "4" (AM "2") setting allows reception of only the strongest stations, while lower settings let you receive weaker stations.

## Switching the reception mode

If a digital broadcast reception condition gets poor, the tuner automatically switches to the analog broadcast of the same frequency level by default. If you want to prevent a frequent automatic switching, switch this setting to [Analog].

1 Touch  on the "Tuner" screen.

## 2 Touch [Blending] to switch the reception mode.

- **Analog:**  
Receives analog broadcasting only.
  - **D/A Auto:**  
Automatically switches to the analog broadcast of the same frequency level as the digital broadcast.
- If you select "**Analog**" on this setting while [Seek] is set to "**HD**", the setting on [Seek] turns to "**All**" automatically.

## Playing audio CDs

You can play a normal music CD using the built in drive of the navigation system. This section describes how.

### Starting procedure

#### 1 Display the AV operation screen.

- For details of the operations, refer to *Displaying the AV operation screen* on page 74.

#### 2 Insert the disc you want to play into disc-loading slot.

Playback starts from the first track of the CD.

- For details, refer to *Inserting and ejecting a disc* on page 17.
- ☐ If the disc is already set, tap [Disc] on the left edge of the screen.
- For details, refer to *Selecting a source* on page 74.

#### 3 Use the touch panel keys on the screen to control the disc.

- For details, refer to *Using the touch panel keys* on the next page. ☐

### Reading the screen

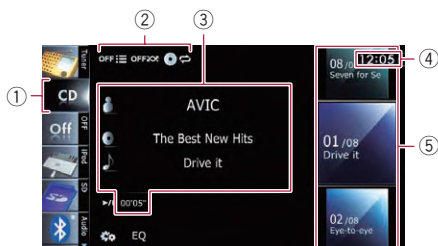

#### ① Source icon

Shows which source has been selected.

#### ② Playback condition indicator

Indicates the current playback condition.

### Scanning tracks of a CD

Indicator	Meaning
	Cancels the scan play.
	Plays the beginning of each track in the current repeat play range for about 10 seconds.

### Playing tracks in random order

Indicator	Meaning
	Does not play tracks in random order.
	Plays all tracks in the current disc in random order.

### Setting a repeat play range

Indicator	Meaning
	Repeats the current disc.
	Repeats just the current track.

#### ③ Current track information

- : **Artist name**  
Shows the artist name of the track currently playing (when available).
- : **Album title**  
Shows the title of the album of the current track (when available).
- : **Track title**  
Shows the title of the track currently playing (when available).
- **Play time**  
Shows the elapsed playing time within the current track.
- ☐ "-----" is displayed if there is no corresponding information.

#### ④ Current time

#### ⑤ Track information

- **Track number indicator**  
Shows the track number and the total number of tracks in the current repeat range.
- **Track title indicator** ☐

## Using the touch panel keys



- ① **Scans tracks of a CD**  
Scan play is performed by touching only one key.  
➔ For details of the operation, refer to **Scans tracks of a CD** on the next page.
- ② **Plays tracks in random order**  
All of the tracks in the disc can be played at random by touching only one key.  
➔ For details of the operation, refer to **Plays tracks in random order** on the next page.
- ③ **Sets a repeat play range**  
The repeat play range can be changed by touching only one key.  
➔ For details, refer to **Changes the repeat range** on the next page.
- ④ **Selects a track to play**  
Scrolling the keys up or down displays tracks, and tapping a track starts playback. Tapping the lower key during random play back skips to the next track. Tapping the upper key jumps to the start of the current track.
- ⑤ **Recalls equalizer curves**  
➔ For details, refer to **Using the equalizer** on page 182.
- ⑥ **Displays the “Function” menu**  
➔ For details, refer to **Using advanced functions** on the next page.
- ⑦ **Playback and Pause**  
Touching [▶/⏸] switches between playback and pause.
- ⑧ **Selects a track from the list**  
Touching the key displays the list which lets you see the list of track titles on a disc. You can play a track on the list by tapping it.



- ☐ “-----” is displayed if there is no corresponding information.  
➔ For details, refer to **Operating list screens** (e.g. iPod list screen) on page 74.
- ⑨ **Switches the media file type played**  
➔ For details, refer to **Switches the media file type played** on page 97. ☐

## Playing audio CDs

### Operating by hardware buttons

#### Pressing the TRK button

You can skip tracks forward or backward.

#### Pressing and holding the TRK button

You can perform fast reverse or fast forward.

### Using advanced functions

#### ● Touch on the "CD" screen.

The "Function" menu appears.

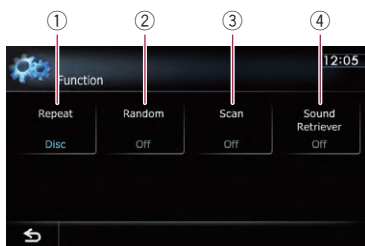

#### ① Changes the repeat range

Each touch of [Repeat] changes the setting as follows:

- **Disc:** Repeats the current disc.
- **Track:** Repeats just the current track.

If you perform track search or fast forward or reverse, track repeat playback is automatically canceled.

#### ② Plays tracks in random order

Each touch of [Random] turns it on or off.

If you turn the random play on when the repeat play range is set to "Track", the repeat play range changes to "Disc" automatically.

#### ③ Scans tracks of a CD

Each touch of [Scan] turns it on or off. Scan play lets you hear the first 10 seconds of each track on the CD. When you find the track you want, touch [Scan] to turn scan play off.

After scanning is finished, normal playback of the tracks will begin again.

If you turn the scan play on when the repeat play range is set to "Track", the repeat play range changes to "Disc" automatically.

#### ④ Uses "Sound Retriever" function

"Sound Retriever" function automatically enhances compressed audio and restores rich sound.

Each touch of [Sound Retriever] changes the setting as follows:

- **MODE 1:** Activates "Sound Retriever" function.
- **MODE 2:** Activates "Sound Retriever" function.
- **Off:** Deactivates "Sound Retriever" function.

"MODE 2" has a stronger effect than "MODE 1" and is more effective when playing back highly compressed audio data.

You can play a disc that contains compressed audio files using the built in drive of the navigation system. This section describes these operations.

- In the following description, the MP3, WMA, AAC files are collectively referred to as “Compressed audio file”.

## Starting procedure

### 1 Display the AV operation screen.

- ➔ For details of the operations, refer to *Displaying the AV operation screen* on page 74.

### 2 Insert the disc you want to play into disc-loading slot.

Playback starts from the first file of the ROM.

- ➔ For details, refer to *Inserting and ejecting a disc* on page 17.
- If the disc is already set, tap [Disc] on the left edge of the screen.
- ➔ For details, refer to *Selecting a source* on page 74.

### 3 Use the touch panel keys on the screen to control the disc.

- ➔ For details concerning operations, refer to *Using the touch panel keys* on page 96. □

## Reading the screen

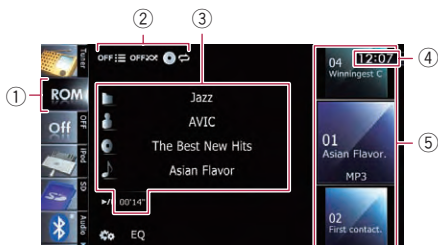

- ① **Source icon**  
Shows which source has been selected.
- ② **Playback condition indicator**  
Indicates the current playback condition.

## Scanning folders and files

Indicator	Meaning
	Cancels the scan play.
	Plays the first audio files of each folder for about 10 seconds when the repeat range is set to "Disc". Plays the beginning of each audio file in the current folder for about 10 seconds when the repeat range is set to "Folder".

## Playing files in random order

Indicator	Meaning
	Does not play files in random order.
	Plays all audio files in the current repeat play range in random order.

## Setting a repeat play range

Indicator	Meaning
	Repeats all compressed audio files.
	Repeats just the current file.
	Repeats the current folder.

### ③ Current file information

- : **Folder name**  
Shows the folder name currently playing.
- : **Artist name**  
Shows the artist name currently playing (when available).
- : **Album title**  
Shows the title of the album of the current file (when available).
- : **Track title**  
Shows the title of the track currently playing (when available).  
□ If the title of a track is not available, the file name appears.
- **Play time**  
Shows the elapsed playing time within the current file.

## Playing music files on ROM

□ "-----" is displayed if there is no corresponding information.

④ **Current time**

⑤ **File information**

- **File number indicator**
- **File name indicator**
- **File type indicator**

Shows the type of audio files. □

## Using the touch panel keys



### ① Scans folders and files

Scan play is performed by touching only one key.

➔ For details of the operation, refer to **Scans folders and files** on the next page.

### ② Plays files in random order

The files in the current repeat play range can be played at random by touching only one key.

☐ If the disc contains a mixture of various media file types, all tracks or files within the current part ("CD" or "ROM") are played randomly.

➔ For details, refer to **Plays files in random order** on the next page.

### ③ Sets a repeat play range

The repeat play range can be changed by touching only one key.

➔ For details, refer to **Changes the repeat range** on the next page.

### ④ Selects a file to play

Scrolling the keys up or down displays files, and tapping a file starts playback.

Tapping the lower key during random playback skips to the next file. Tapping the upper key jumps to the start of the current file.

### ⑤ Recalls equalizer curves

➔ For details, refer to *Using the equalizer* on page 182.

### ⑥ Displays the "Function" menu

➔ For details, refer to *Using advanced functions* on the next page.

### ⑦ Playback and Pause

Touching [▶/||] switches between playback and pause.

### ⑧ Selects a file from the list

Touching the key displays the list which lets you see the list of track titles or folder names on a disc.

☐ If the title of a track is not available, the file name appears.

Tapping a folder on the list shows its content. You can play a file on the list by tapping it.





## Playing music files on ROM

➔ For details, refer to *Operating list screens* (e.g. *iPod list screen*) on page 74.

Touching [L] displays the content of the upper folder (parent folder). If the uppermost folder is listed, [L] cannot be used.

### ⑨ Switches the media file type played

When playing a disc containing a mixture of various media file types, you can switch between media file types to play.

Tap the key repeatedly to switch between the following media file types:

**CD** (audio data (CD DA))    **ROM** (compressed audio file)    **DivX** (DivX video files) [M]

## Operating by hardware buttons

### Pressing the TRK button

You can skip files forward or backward.

### Pressing and holding the TRK button

You can perform fast reverse or fast forward. [M]

## Using advanced functions

### ● Touch [F] on the "ROM" screen.

The "Function" menu appears.

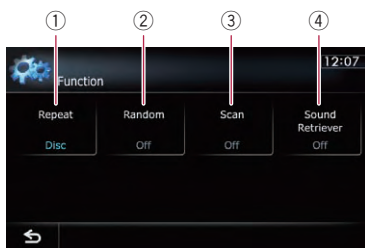

### ① Changes the repeat range

Each touch of [Repeat] changes the setting as follows:

- **Disc**: Repeats all compressed audio files.
- **Track**: Repeats just the current file.

- **Folder**: Repeats the current folder.

- ❑ If you select another folder during repeat play, the repeat play range changes to "Disc".
- ❑ If you perform fast reverse or fast forward during "Track", the repeat play range changes to "Folder".
- ❑ When "Folder" is selected, it is not possible to playback a subfolder of that folder.
- ❑ When playing discs with compressed audio files and audio data (CD DA), repeat play is performed within the currently playing data session even if "Disc" is selected.

### ② Plays files in random order

Each touch of [Random] turns it on or off. When the random play is turned on, the files in the current repeat play range are randomly played.

- ❑ If you turn the random play on when the repeat play range is set to "Track", the repeat play range changes to "Folder" automatically.

### ③ Scans folders and files

Scan play lets you hear the first 10 seconds of each file. Scan play is performed in the current repeat play range.

Each touch of [Scan] turns it on or off. When you find the file you want, touch [Scan] to turn the scan play off.

- ❑ After completion of file or folder scanning, normal playback of the files will begin again.
- ❑ If you turn the scan play on when the repeat play range is set to "Track", the repeat play range changes to "Folder" automatically.
- ❑ If you turn the scan play on while the repeat play range is set to "Disc", scan play is performed for only the first file of each folder.

### ④ Uses "Sound Retriever" function

"Sound Retriever" function automatically enhances compressed audio and restores rich sound.

Each touch of [**Sound Retriever**] changes the setting as follows:

- **MODE 1:** Activates "**Sound Retriever**" function.
  - **MODE 2:** Activates "**Sound Retriever**" function.
  - **Off:** Deactivates "**Sound Retriever**" function.
- "**MODE 2**" has a stronger effect than "**MODE 1**" and is more effective when playing back highly compressed audio data. □

## Playing a DVD-Video

You can play a DVD Video using the built in drive of the navigation system. This section describes operations for playing a DVD Video.

### Starting procedure

#### 1 Display the AV operation screen.

- For details of the operations, refer to *Displaying the AV operation screen* on page 74.

#### 2 Insert the disc you want to play into disc-loading slot.

The source changes and then playback will start.

- For details, refer to *Inserting and ejecting a disc* on page 17.
- If the disc is already set, tap **[Disc]** on the left edge of the screen.
- For details, refer to **Selecting a source** on page 74.

#### 3 Use the touch panel keys on the screen to control the disc.

- For details, refer to *Using the touch panel keys* on the next page. □

- ④ **Audio channel indicator**  
Shows the current audio channel type, such as “Mch” (Multi channel).
- ⑤ **Subtitle number indicator**  
Shows the subtitle number currently selected.
- ⑥ **Subtitle language indicator**  
Shows the subtitle language currently selected.
- ⑦ **Viewing angle indicator**  
Shows what viewing angle has been selected.
- ⑧ **Current time**
- ⑨ **Digital sound format indicator**  
Shows which digital sound format (surround sound format) has been selected.
- ⑩ **Play time indicator**  
Shows the elapsed playing time within the current title.
- ⑪ **Source icon**  
Shows which source has been selected. □

### Reading the screen



- ① **Title number indicator**  
Shows the title number currently playing.
- ② **Audio track indicator**  
Shows the audio track number and audio language currently selected.
- ③ **Chapter number indicator**  
Shows the chapter number currently playing.

## Using the touch panel keys

Playback screen (page 1)

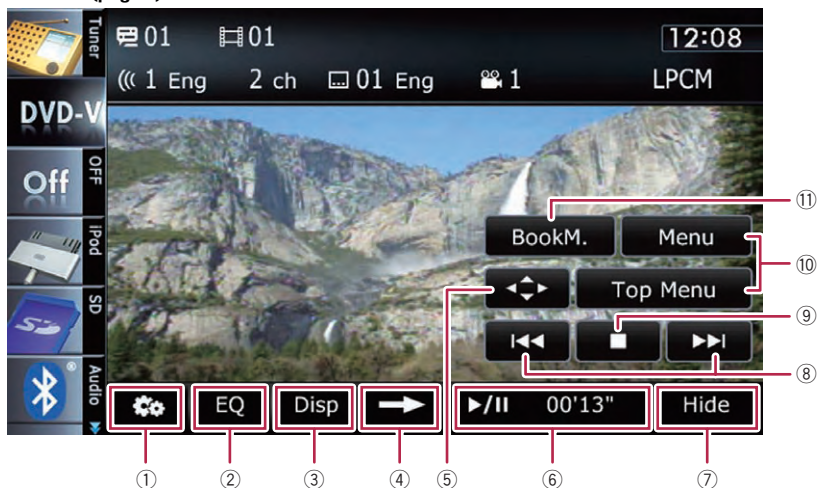

Playback screen (page 2)

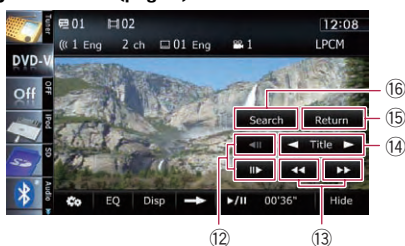

Playback screen (page 3)

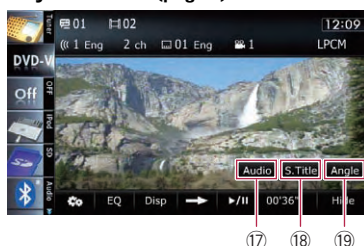

- ❑ With some discs, the icon  may be displayed, meaning that the operation is invalid.

- ① **Displays the "Function" menu**  
 ➔ For details, refer to *Using advanced functions* on page 103.
- ② **Recalls equalizer curves**  
 ➔ For details, refer to *Using the equalizer* on page 182.
- ③ **Switches the display**  
 Touching [Disp] changes the indication on the information plate as follows:  
 Disc information display    Repeat range and L/R select display

- ④ **Switches to the next page of touch panel keys**

- ⑤ **Displays the DVD menu keypad**  
 ➔ For details, refer to *Using DVD menu by touch panel keys* on page 102.

- ⑥ **Playback and Pause**

Touching [▶/⏸] switches between playback and pause.

- ⑦ **Hides the touch panel keys and information of the current video**

Touching [Hide] shows only the current video.

- ❑ If you want to display the touch panel keys and information of the current video again, touch anywhere on the LCD screen.

## Playing a DVD-Video

### ⑧ Skips forward or backward

Touching [▶▶] skips to the start of the next chapter. Touching [◀◀] once skips to the start of the current chapter. Touching it twice quickly will skip to the previous chapter.

### ⑨ Stops playback

When [■] is touched once to stop playback, playback can be resumed from the stopped position. When [■] is touched two times to stop playback, playback returns to the beginning.

### ⑩ Displays the DVD menu

You can display the menu by touching [Menu] or [Top Menu] while a disc is playing. Touching either of these keys again lets you start playback from the location selected from the menu. For details, refer to the instructions provided with the disc.

### ⑪ Resumes playback (Bookmark)

➔ For details, refer to *Resuming playback (Bookmark)* on this page.

### ⑫ Frame-by-frame playback (or slow-motion playback)

➔ For details, refer to *Frame by frame playback* on page 103.

➔ For details, refer to *Slow motion playback* on page 103.

### ⑬ Fast reverse or forward

Touch and hold [◀◀] or [▶▶] to perform fast reverse or forward.

If you keep touching [◀◀] or [▶▶] for five seconds, fast reverse/fast forward continues even if you release either of these keys. To resume playback at a desired point, touch [▶/II] or opposite key of [◀◀] or [▶▶] which you touched.

### ⑭ Skips the title forward or backward

Touching [▶] skips to the start of the next title. Touching [◀] skips to the start of the previous title.

### ⑮ Performs an operation (such as resuming) that is stored on the disc

When using a DVD that has a point recorded that indicates where to return to, the DVD returns to the specified point and begins playback from that point.

### ⑯ Searches for a desired scene and starts playback from a specified time

➔ For details, refer to *Searching for a specific scene and starting playback from a specified time* on the next page.

### ⑰ Changes the audio track (Multi-audio)

Each touch of [Audio] switches between audio tracks recorded in the disc.

DTS audio format cannot be output, so select an audio track other than DTS audio format.

Display indications such as **MPEG-A** and **Mch** describe the audio track recorded on the DVD. This indication may not be the same as the actual sound currently output from the navigation system.

### ⑱ Changes the subtitle (Multi-subtitle)

Each touch of [S.Title] switches between the subtitle languages recorded on the disc.

### ⑲ Changes the viewing angle (Multi-angle)

Each touch of [Angle] switches between viewing angles.

During playback of a scene shot from multiple angles, the angle icon  is displayed. Turn the angle icon display on or off using the "DVD/DivX® Setup" menu.

➔ For details, refer to *Setting the angle icon display* on page 109.

## Resuming playback (Bookmark)

The Bookmark function lets you resume playback from a selected scene the next time the disc is loaded.

### ● Touch [BookM.].



You can bookmark one point for each of up to five discs. If you try to memorize another point for the same disc, the older bookmark will be overwritten by the newer one.

- To clear the bookmark on a disc, touch and hold **[BookM.]**.

## Searching for a specific scene and starting playback from a specified time

You can search for the scene you want by specifying a title or a chapter, and the time.

- Chapter search and time search are not available when disc playback has been stopped.

**1 Touch [Search] and then touch [Title] (title), [Chapter] (chapter), [Time] (time).**

**2 Touch the keys to input the target number or time and then touch [Enter].**

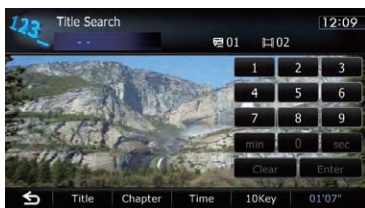

### For titles, chapters

- To select 3, touch **[3]** and **[Enter]** in order.
- To select 10, touch **[1]** and **[0]** and **[Enter]** in order.

### For time (time search)

- To select 5 minutes 3 seconds, touch **[5]**, **[min]**, **[3]**, **[sec]** and **[Enter]** in order.
- To select 71 minutes 00 seconds, touch **[7]**, **[1]**, **[min]** and **[Enter]** in order.
- To select 100 minutes 05 seconds, touch **[1]**, **[0]**, **[0]**, **[5]**, **[sec]** and **[Enter]** in order.
- To cancel an input number, touch **[Clear]**. To cancel the input numbers, touch and hold **[Clear]**.

## Direct number search

You can use this function when you need to enter a numerical command during DVD playback.

**1 Touch [Search].**



**2 Touch [10Key].**

**3 Touch [0] to [9] to input the desired number.**

**4 While the input number is displayed, touch [Enter].**

## Operating the DVD menu

You can operate the DVD menu by touching the menu item on the screen directly.

- This function can be used when the  key is displayed on the lower right corner of the LCD screen.
- This function may not work properly with some DVD disc content. In that case, use touch panel keys to operate the DVD menu.
- If you touch the screen while  is displayed, the touch panel keys will not be displayed.

**1 Touch the screen to display the touch panel keys.**

**2 Touch [Top Menu] or [Menu] to display touch panel keys to operate the DVD menu.**

**3 Touch the desired menu item.**

- If you touch , the touch panel keys for selecting the menu item are displayed.

## Using DVD menu by touch panel keys

If items on the DVD menu appear, the touch panel keys may overlay them. If so, select an item using those touch panel keys.

## Playing a DVD-Video

- 1 Touch [▲], [▼], [◀] or [▶] to select the desired menu item.

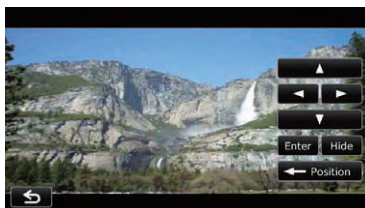

- If the touch panel keys for DVD menu selection disappear, touching anywhere on the screen, then touch . The touch panel keys are displayed again.

- 2 Touch [Enter].

Playback starts from the selected menu item. The way to display the menu differs depending on the disc.

- If you touch [Position], the display position of touch panel keys is changed each time you touch it.
- If you touch [Hide], the touch panel keys disappear and the  icon is displayed. You can select a menu item by touching it.

### Frame-by-frame playback

This lets you move ahead one frame at a time during pause.

- Touch [II▶] during pause.

Each time you touch [II▶], you move ahead one frame.

- To return to normal playback, touch [▶/II].
- With some discs, images may be unclear during frame by frame playback.

### Slow motion playback

This lets you slow down playback speed.

- 1 Touch and hold [II▶] until  is displayed during playback.

The icon  is displayed, and forward slow motion playback begins.

- To return to normal playback, touch [▶/II].

- 2 Touch [◀II] or [II▶] to adjust playback speed during slow motion playback.

Each time you touch [◀II] or [II▶] it changes the speed in four steps in the following order:

1/16 ↔ 1/8 ↔ 1/4 ↔ 1/2

- There is no sound during slow motion playback.
- With some discs, images may be unclear during slow motion playback.
- Reversed slow motion playback is not possible. 

## Operating by hardware buttons

### Pressing the TRK button

You can skip chapters forward or backward.

### Pressing and holding the TRK button

You can perform fast reverse or fast forward. 

## Using advanced functions

- Touch  on the "DVD-V" screen.

The "Function" menu appears.

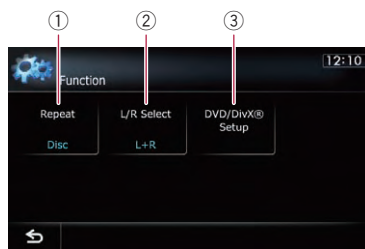

- ① Changes the repeat range

Each touch of [Repeat] changes the setting as follows:

- **Disc:** Plays throughout the current disc.
- **Chapter:** Repeats just the current chapter.
- **Title:** Repeats just the current title.

- ❑ If you perform chapter (title) search, fast forward, fast reverse or slow motion playback, the repeat play range changes to "**Disc**".
- ❑ This function is not available when disc playback has been stopped.

### ② **Selects audio output**

When playing DVDs recorded with LPCM audio, you can switch the audio output. Touch **[L/R Select]** repeatedly until the desired audio output appears on the display. Each touch of **[L/R Select]** changes the settings as follows:

- **L+R**: Left and right
  - **L**: Left
  - **R**: Right
  - **Mix**: Mixing left and right
- ❑ This function is not available when disc playback has been stopped.

### ③ **DVD setup adjustments**

- ➞ For details, refer to *Displaying DVD/DivX® Setup menu* on page 109. 



## Playing a DivX video

You can play a DivX disc using the built in drive of the navigation system. This section describes those operations.

### Starting procedure

#### 1 Display the AV operation screen.

- For details of the operations, refer to *Displaying the AV operation screen* on page 74.

#### 2 Insert the disc you want to play into disc-loading slot.

The source changes and then playback will start.

- For details, refer to *Inserting and ejecting a disc* on page 17.
- If the disc is already set, tap **[Disc]** on the left edge of the screen.
- For details, refer to **Selecting a source** on page 74.

#### 3 Use the touch panel keys on the screen to control the disc.

- For details, refer to *Using the touch panel keys* on the next page. ■

#### ④ Audio channel indicator

Shows the current audio channel type, such as “Mch” (Multi channel).

#### ⑤ Subtitle number indicator

Shows the subtitle number currently selected.

#### ⑥ Repeat range indicator

Shows which repeat range has been selected.

- For details, refer to **Changes the repeat range** on page 108.

#### ⑦ Current time

#### ⑧ Digital sound format indicator

Shows the digital sound format (surround sound format) currently selected.

#### ⑨ Play time indicator

Shows the elapsed playing time within the current file.

#### ⑩ Source icon

Shows which source has been selected. ■

### Reading the screen



#### ① Folder number indicator

Shows the folder number currently playing.

#### ② Audio track indicator

Shows the audio track number currently selected.

#### ③ File number indicator

Shows the file number currently playing.

## Using the touch panel keys

Playback screen (page 1)

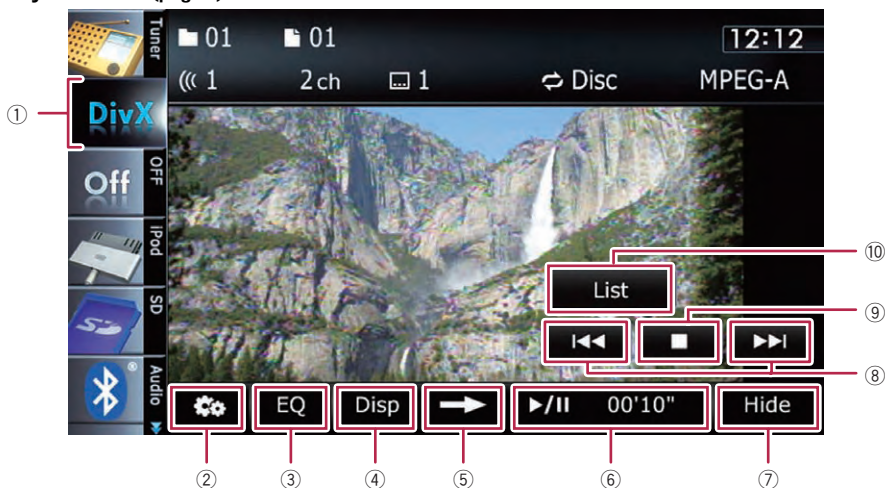

Playback screen (page 2)

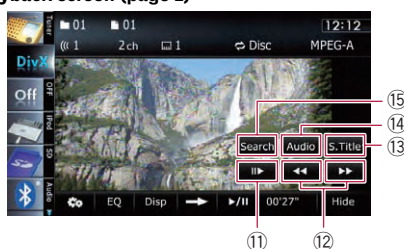

- ❑ With some discs, the icon  may be displayed, meaning that the operation is invalid.

### ① Switches the media file type played

When playing a disc containing a mixture of various media file types, you can switch between media file types to play.

Tap the key repeatedly to switch between the following media file types:

**CD** (audio data (CD DA))    **ROM** (compressed audio file)    **DivX** (DivX video files)

### ② Displays the "Function" menu

➔ For details, refer to *Using advanced functions* on page 108.

### ③ Recalls equalizer curves

- ➔ For details, refer to *Using the equalizer* on page 182.

### ④ Switches the information

Touching **[Disp]** changes the content of the information panel as follows:

Disc information display    Current folder name display    Current file name display

### ⑤ Switches to the next page of touch panel keys

### ⑥ Playback and Pause

Touching **[▶/||]** switches between playback and pause.

### ⑦ Hides the touch panel keys and information of the current video

Touching **[Hide]** shows only the current video.

## Playing a DivX video

- If you want to display the touch panel keys and information of the current video again, touch anywhere on the LCD screen.
- ⑧ **Skips forward or backward**  
Touching [▶▶] skips to the start of the next file. Touching [◀◀] once skips to the start of the current file. Touching it twice quickly will skip to the previous file.
- ⑨ **Stops playback**  
When [■] is touched once to stop playback, playback can be resumed from the stopped position. When [■] is touched two times to stop playback, playback returns to the beginning.
- ⑩ **Selects a file from the list**  
Touching the key displays the list which lets you find file names or folder names on a disc.
  - A dash ( ) is displayed if there is no corresponding information.
 Tapping a folder on the list shows its content. You can play a file on the list by tapping it.

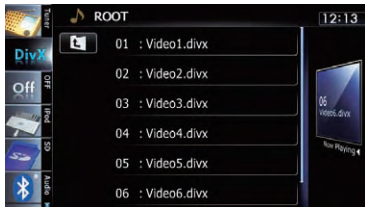

- ➔ For details, refer to *Operating list screens (e.g. iPod list screen)* on page 74.  
The contents of the folder in which the currently playing file is located are displayed. Touching [⏪] displays the content of the upper folder (parent folder). If the uppermost folder is listed, [⏪] cannot be used.
- ⑪ **Frame-by-frame playback (or slow-motion playback)**
  - ➔ For details, refer to *Frame by frame playback* on this page.
  - ➔ For details, refer to *Slow motion playback* on this page.
- ⑫ **Fast reverse or forward**  
Touch and hold [◀◀] or [▶▶] to perform fast reverse or forward.

If you keep touching [◀◀] or [▶▶] for five seconds, fast reverse/fast forward continues even if you release either of these keys. To resume playback at a desired point, touch [▶/■] or opposite key of [◀◀] or [▶▶] which you touched.

- ⑬ **Changes the subtitle (Multi-subtitle)**  
Each touch of [S.Title] switches between the subtitle languages recorded on the disc.
- ⑭ **Changes audio tracks (Multi-audio)**  
Each touch of [Audio] switches between audio tracks.
- ⑮ **Searches for a desired scene and starts playback from a specified time**
  - ➔ For details, refer to *Starting playback from a specified time* on the next page.

### Frame-by-frame playback

This lets you move ahead one frame at a time during pause.

- **Touch [⏩] during pause.**

Each time you touch [⏩], you move ahead one frame.

- To return to normal playback, touch [▶/■].
- With some discs, images may be unclear during frame by frame playback.

### Slow motion playback

This lets you slow down playback speed.

- **Touch and hold [⏩] until ⏩ is displayed during playback.**

The icon ⏩ is displayed, and forward slow motion playback begins.

- To return to normal playback, touch [▶▶] or [◀◀], etc.
- There is no sound during slow motion playback.
- With some discs, images may be unclear during slow motion playback.
- Reversed slow motion playback is not possible.

## Starting playback from a specified time

You can search for a desired scene by specifying the time.

- ❑ Time search are not possible when disc playback has been stopped.

### 1 Touch [Search].

### 2 Touch the keys to input the target number or time and then touch [Enter].

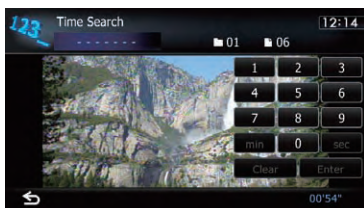

- To select 5 minutes 3 seconds, touch [5], [min], [3], [sec] and [Enter] in order.
- To select 71 minutes 00 seconds, touch [7], [1], [min] and [Enter] in order.
- To select 100 minutes 05 seconds, touch [1], [0], [0], [5], [sec] and [Enter] in order.
- ❑ To cancel an input number, touch [Clear]. To cancel the input numbers, touch and hold [Clear].

## Operating by hardware buttons

### Pressing the TRK button

You can skip files forward or backward.

### Pressing and holding the TRK button

You can perform fast reverse or fast forward.

## Using advanced functions

- Touch on the "DivX" screen.

The "Function" menu appears.

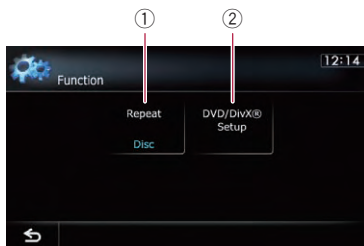

### ① Changes the repeat range

Each touch of [Repeat] changes the setting as follows:

- **Disc:** Plays throughout the current disc.
- **File:** Repeats just the current file.
- **Folder:** Repeats just the current folder.
- ❑ If you select another folder during repeat play, the repeat play range changes to "Disc".
- ❑ If you perform fast reverse or fast forward during "File", the repeat play range changes to "Folder".
- ❑ When "Folder" is selected, it is not possible to playback a subfolder of that folder.
- ❑ When playing discs with compressed audio files and audio data (CD DA), repeat play is performed within DivX videos even if "Disc" is selected.

### ② DVD setup adjustments

- ➔ For details, refer to *Displaying DVD/DivX® Setup* menu on the next page.

## DVD-Video or DivX setup

This chapter describes how to configure the DVD Video/DivX player.

### Displaying DVD/DivX® Setup menu

#### 1 Play the disc that contains DVD-Video or DivX.

#### 2 Display the AV operation screen.

- For details of the operations, refer to *Displaying the AV operation screen* on page 74.

#### 3 Touch .

The “Function” menu appears.

#### 4 Touch [DVD/DivX® Setup].

The “DVD/DivX® Setup” screen appears.

#### 5 Touch the desired function.



### Setting the top-priority languages

You can assign the top priority language to the top priority subtitle, audio and menu in initial playback. If the selected language is recorded on the disc, subtitles, audio and menu are displayed or output in that language.

#### 1 Display the “DVD/DivX® Setup” screen.

- For details, refer to *Displaying DVD/DivX® Setup menu* on this page.

#### 2 Touch [Subtitle Language], [Audio Language] or [Menu Language].

Each language menu is displayed and the currently set language is selected.

#### 3 Touch the desired language.

When you select “Others”, a language code input display is shown. Input the four digit code of the desired language then touch [Enter].

- For details, refer to *Language code chart for DVDs* on page 112.
- ❑ If the selected language is not recorded on the disc, the default language specified on the disc is output and displayed.
- ❑ You can also switch the subtitle and audio language by touching [S.Title] or [Audio] during playback. Even if you touch [S.Title] or [Audio] to switch the subtitle or audio language, this setting will not change. 

### Setting the angle icon display

You can set the angle icon  to display in scenes where the angle can be switched.

#### 1 Display the “DVD/DivX® Setup” screen.

- For details, refer to *Displaying DVD/DivX® Setup menu* on this page.

#### 2 Touch [Multi Angle].

Each time you touch the key changes the setting.

- **On** (default): Displays the angle icon in scenes where the angle can be switched.
- **Off**: Hides the angle icon. 

## Setting the aspect ratio

There are two kinds of displays. A wide screen display has a width to height ratio (TV aspect) of 16:9, while a regular display has a TV aspect of 4:3. If you use a regular rear display with a TV aspect of 4:3, you can set the aspect ratio suitable for your rear display. (We recommend use of this function only when you want to fit it to the rear display.)

- When using a regular display, select either "**Letter Box**" or "**Panscan**". Selecting "**16:9**" may result in an unnatural image.

### 1 Display the "DVD/DivX® Setup" screen.

- ➔ For details, refer to *Displaying DVD/DivX® Setup menu* on the previous page.

### 2 Touch [TV Aspect].

Each touch of [TV Aspect] changes the setting as follows:

- **16:9**: Wide screen image (16:9) is displayed as it is (initial setting).
  - **Letter Box**: The image is in the shape of a letter box with black bands at the top and bottom of the screen.
  - **Panscan**: The image is cut short at the right and left of the screen.
- When playing discs that do not have a pan scan system, the disc is played back with "**Letter Box**" even if you select "**Panscan**" setting. Confirm whether the disc package bears the **16:9 LB** mark.
  - Some discs do not enable changing of the TV aspect. For details, refer to the disc's instructions.

## Setting the parental lock

Some DVD Video discs let you use parental lock to set restrictions so that children cannot watch violent or adult oriented scenes. You can set the parental lock level in steps as desired.

- When you set a parental lock level and then play a disc featuring parental lock, code number input indications may be dis-

played. In this case, playback will begin when the correct code number is input.

## Setting the code number and level

When you first use this function, register your code number. If you do not register a code number, parental lock will not operate.

### 1 Display the "DVD/DivX® Setup" screen.

- ➔ For details, refer to *Displaying DVD/DivX® Setup menu* on the previous page.

### 2 Touch [Parental Level].

### 3 Touch [0] to [9] to input a four-digit code number.

### 4 While the input number is displayed, touch [Enter].



The code number is registered, and you can now set the level.

### 5 Touch any of [1] to [8] to select the desired level.

The parental lock level is set.

- **Level 8**: Playback of the entire disc is possible (initial setting).
  - **Level 7 to Level 2**: Playback of discs for children and non adult oriented discs is possible.
  - **Level 1**: Only playback of discs for children is possible.
- If you want to change the parental level already set, enter the registered code number and then select the parental level.
  - We recommend that you keep a record of your code number in case you forget it.
  - The parental lock level is recorded on the disc. You can confirm it by looking at the disc package, the included literature or the disc itself. You cannot use parental lock with discs that do not feature a recorded parental lock level.
  - With some discs, parental lock operates to skip certain scenes only, after which normal playback resumes. For details, refer to the disc's instructions.

## DVD-Video or DivX setup

- ❑ If you forget the registered code number, touch  10 times on the number input screen. The registered code number is canceled, letting you register a new one. 

### Setting the auto play

When a DVD disc with DVD menu is inserted, this unit will cancel the DVD menu automatically and start playback from the first chapter of the first title.

- ❑ This function is available for DVD Video.
- ❑ Some DVDs may not operate properly. If this function is not fully operable, turn this function off and start playback.

#### 1 Display the “DVD/DivX® Setup” screen.

- ➔ For details, refer to *Displaying DVD/DivX® Setup menu* on page 109.

#### 2 Touch [Auto Play].

Each touch of [Auto Play] changes the settings as follows:

- **Off** (default):  
Deactivates the auto play function.
- **On**:  
Activates the auto play function.
- ❑ When “Auto Play” is set to “On”, the repeat range is automatically set to “Disc”. 

### Setting the subtitle file for DivX

You can select whether to display DivX external subtitles or not.

- ❑ If no DivX external subtitle files exist, the original DivX subtitles are displayed even when “Custom” is selected.

#### 1 Display the “DVD/DivX® Setup” screen.

- ➔ For details, refer to *Displaying DVD/DivX® Setup menu* on page 109.

#### 2 Touch [Subtitle File].

Touching [Subtitle File] switches this setting between “Original” and “Custom”.

- ❑ Up to 42 characters can be displayed on one line. If more than 42 characters are set, the line breaks and the characters are displayed on the next line.
- ❑ Up to 126 characters can be displayed on one screen. If more than 126 characters are set, the excess characters will not be displayed.
- ❑ The DivX subtitles will be displayed even when the subtitle file setting is on if no corresponding subtitle files exist.
- ❑ Up to three subtitle lines can be displayed at once. 

## Language code chart for DVDs

Two-letter code, input code	Language	Two-letter code, input code	Language	Two-letter code, input code	Language
aa, 0101	Afar	ia, 0901	Interlingua	rn, 1814	Rundi
ab, 0102	Abkhazian	ie, 0905	Interlingue	ro, 1815	Romanian
af, 0106	Afrikaans	ik, 0911	Inupiaq	ru, 1821	Russian
am, 0113	Amharic	in, 0914	Indonesian	rw, 1823	Kinyarwanda
ar, 0118	Arabic	is, 0919	Icelandic	sa, 1901	Sanskrit
as, 0119	Assamese	it, 0920	Italian	sd, 1904	Sindhi
ay, 0125	Aymara	ja, 1001	Japanese	sg, 1907	Sango
az, 0126	Azerbaijani	ji, 1009	Yiddish	sh, 1908	Serbo Croatian
ba, 0201	Bashkir	jw, 1023	Javanese	si, 1909	Sinhala
be, 0205	Belarusian	ka, 1101	Georgian	sk, 1911	Slovak
bg, 0207	Bulgarian	kk, 1111	Kazakh	sl, 1912	Slovenian
bh, 0208	Bihari	kl, 1112	Kalaallisut	sm, 1913	Samoan
bi, 0209	Bislama	km, 1113	Central Khmer	sn, 1914	Shona
bn, 0214	Bengali	kn, 1114	Kannada	so, 1915	Somali
bo, 0215	Tibetan	ko, 1115	Korean	sq, 1917	Albanian
br, 0218	Breton	ks, 1119	Kashmiri	sr, 1918	Serbian
ca, 0301	Catalan	ku, 1121	Kurdish	ss, 1919	Swati
co, 0315	Corsican	ky, 1125	Kirghiz; Kyrgyz	st, 1920	Sotho, Southern
cs, 0319	Czech	la, 1201	Latin	su, 1921	Sundanese
cy, 0325	Welsh	ln, 1214	Lingala	sv, 1922	Swedish
da, 0401	Danish	lo, 1215	Lao	sw, 1923	Swahili
de, 0405	German	lt, 1220	Lithuanian	ta, 2001	Tamil
dz, 0426	Dzongkha	lv, 1222	Latvian	te, 2005	Telugu
ee, 0505	Ewe	mg, 1307	Malagasy	tg, 2007	Tajik
el, 0512	Greek	mi, 1309	Maori	th, 2008	Thai
en, 0514	English	mk, 1311	Macedonian	ti, 2009	Tigrinya
eo, 0515	Esperanto	ml, 1312	Malayalam	tk, 2011	Turkmen
es, 0519	Spanish	mn, 1314	Mongolian	tl, 2012	Tagalog
et, 0520	Estonian	mo, 1315	Moldavian	tn, 2014	Tswana
eu, 0521	Basque	mr, 1318	Marathi	to, 2015	Tonga
fa, 0601	Persian	ms, 1319	Malay	tr, 2018	Turkish
fi, 0609	Finnish	mt, 1320	Maltese	ts, 2019	Tsonga
fj, 0610	Fijian	my, 1325	Burmese	tt, 2020	Tatar
fo, 0615	Faroese	na, 1401	Nauru	tw, 2023	Twi
fr, 0618	French	ne, 1405	Nepali	uk, 2111	Ukrainian
fy, 0625	Western Frisian	nl, 1412	Dutch; Flemish	ur, 2118	Urdu
ga, 0701	Irish	no, 1415	Norwegian	uz, 2126	Uzbek
gd, 0704	Gaelic	oc, 1503	Occitan	vi, 2209	Vietnamese
gl, 0712	Galician	om, 1513	Oromo	vo, 2215	Volapuk
gn, 0714	Guarani	or, 1518	Oriya	wo, 2315	Wolof
gu, 0721	Gujarati	pa, 1601	Panjabi; Punjabi	xh, 2408	Xhosa
ha, 0801	Hausa	pl, 1612	Polish	yo, 2515	Yoruba
hi, 0809	Hindi	ps, 1619	Pushto; Pashto	zh, 2608	Chinese
hr, 0818	Croatian	pt, 1620	Portuguese	zu, 2621	Zulu
hu, 0821	Hungarian	qu, 1721	Quechua		
hy, 0825	Armenian	rm, 1813	Romansh		





## Playing music files (from USB or SD)

You can play the compressed audio files stored in the external storage device (USB, SD).

- In the following description, the SD memory card and USB memory device are collectively referred to as the “external storage device (USB, SD)”. If it indicates the USB memory device only, it is referred to as the “USB storage device”.

### Starting procedure

#### 1 Display the AV operation screen.

- ➔ For details of the operations, refer to *Displaying the AV operation screen* on page 74.

#### 2 Insert the SD memory card into the SD card slot or plug the USB storage device into the USB connector.

- ➔ For details, refer to *Plugging in a USB storage device* on page 22.
- ➔ For details, refer to *Inserting and ejecting an SD memory card* on page 18.

- Playback is performed in order of folder numbers. Folders are skipped if they contain no playable files. If there are no playable files in folder 01 (root folder), playback starts from folder 02.

#### 3 Tap [USB] or [SD] on the left edge of the screen to display the “USB” or “SD” screen.

#### 4 Use the touch panel keys on the screen to control the external storage device (USB, SD).

- ➔ For details, refer to *Using the touch panel keys (Music)* on page 115. □

### Reading the screen

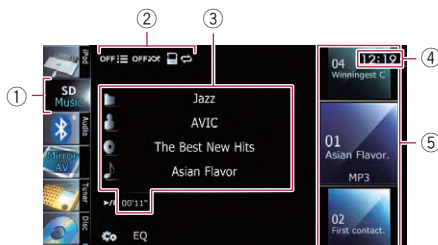

- This unit may not achieve optimum performance with some external storage devices.
- You can playback the files on a USB storage device compliant with Mass Storage Class. For details about the USB Class, refer to the manual supplied with the USB storage device.

#### ① Source icon

Shows which source has been selected.

#### ② Playback condition indicator

Indicates the current playback condition.



#### Scanning folders and files

Indicator	Meaning
	Cancels the scan play.
	Plays the first audio files of each folder for about 10 seconds when the repeat range is set to “Media”. Plays the beginning of each audio file in the current folder for about 10 seconds when the repeat range is set to “Folder”.





#### Playing files in random order

Indicator	Meaning
	Does not play files in random order.
	Plays all audio files in the current repeat play range in random order.

**Setting a repeat play range**

Indicator	Meaning
	Repeats all compressed audio files in the selected external storage device (USB, SD).
	Repeats just the current file.
	Repeats the current folder.

**③ Current file information**

-  **Folder name**  
Shows the folder name currently playing.
-  **Artist name**  
Shows the artist name currently playing (when available).
-  **Album title**  
Shows the title of the album of the current file (when available).
-  **Track title**  
Shows the title of the track currently playing (when available).  
 If the title of a track is not available, the file name appears.
- **Play time**  
Shows the elapsed playing time within the current file.  
 "-----" is displayed if there is no corresponding information.

**④ Current time****⑤ File information**

- **File number indicator**
- **File name indicator**
- **File type indicator**  
Shows the type of audio files.

## Playing music files (from USB or SD)

### Using the touch panel keys (Music)



- ① **Scans folders and files**  
Scan play is performed by touching only one key.  
➔ For details of the operation, refer to **Scans folders and files** on the next page.
- ② **Plays files in random order**  
The files in the current repeat play range can be played at random by touching only one key.  
➔ For details of the operation, refer to **Plays files in random order** on the next page.
- ③ **Sets a repeat play range**  
The repeat play range can be changed by touching only one key.  
➔ For details, refer to **Changes the repeat range** on the next page.
- ④ **Selects a file to play**  
Scrolling the keys up or down displays files, and tapping a file starts playback. Tapping the lower key during random play back skips to the next file. Tapping the upper key jumps to the start of the current file.
- ⑤ **Recalls equalizer curves**  
➔ For details, refer to *Using the equalizer* on page 182.
- ⑥ **Displays the "Function" menu**  
➔ For details, refer to *Using advanced functions* on the next page.
- ⑦ **Playback and Pause**  
Touching [▶/⏸] switches between playback and pause.
- ⑧ **Selects a file from the list**  
Touching the key displays the list which lets you find track titles or folder names on an external storage device (USB, SD). Tapping a folder on the list shows its content. You can play a file on the list by tapping it.

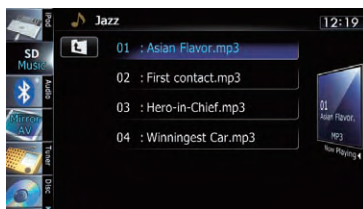

- ➔ For details, refer to *Operating list screens* (e.g. iPod list screen) on page 74.
- Touching [⏪] displays the content of the upper folder (parent folder). If the uppermost folder is listed, [⏪] cannot be used.

### ⑨ Switches the operation screen

Tapping this key switches between the screen to operate music files and the screen to operate video files. This touch panel key is available only when there are both audio and video files in the external storage device (USB, SD). 

## Operating by hardware buttons

### Pressing the TRK button

You can skip files forward or backward.

### Pressing and holding the TRK button

You can perform fast reverse or fast forward. 

## Using advanced functions

### ● Touch on the "USB" or "SD" screen.

The "Function" menu appears.

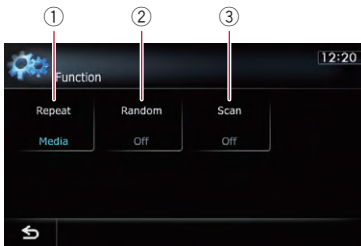

### ① Changes the repeat range

Each touch of [**Repeat**] changes the setting as follows:

- **Media**: Repeats all compressed audio files in the selected external storage device (USB, SD).
  - **Track**: Repeats just the current file.
  - **Folder**: Repeats the current folder.
- If you skip the file forward or backward when the repeat play range in "Track", the repeat play range changes to "Folder".

### ② Plays files in random order

Random play lets you playback files in random order within the current repeat range. Each touch of [**Random**] turns it on or off.

- If you turn the random play on when the repeat play range is set to "Track", the repeat play range changes to "Folder" automatically.

### ③ Scans folders and files

Scan play lets you hear the first 10 seconds of each file. Scan play is performed in the current repeat play range.

Each touch of [**Scan**] turns it on or off.

When you find the file you want, touch [**Scan**] to turn the scan play off.

- After all files or folders scanning are finished, normal playback will begin again.
- If you turn the scan play on when the repeat play range is set to "Track", the repeat play range changes to "Folder" automatically. 

## Playing video files (from USB or SD)

You can play the video files stored in the external storage device (USB, SD).

- In the following description, the SD memory card and USB memory device are collectively referred to as the “external storage device (USB, SD)”. If it indicates the USB memory device only, it is referred to as the “USB storage device”.

### Starting procedure

#### 1 Display the AV operation screen.

- ➔ For details of the operations, refer to *Displaying the AV operation screen* on page 74.

#### 2 Insert the SD memory card into the SD card slot or plug the USB storage device into the USB connector.

- ➔ For details, refer to *Plugging in a USB storage device* on page 22.
- ➔ For details, refer to *Inserting and ejecting an SD memory card* on page 18.
- Playback is performed in order of folder numbers. Folders are skipped if they contain no playable files. If there are no playable files in folder 01 (root folder), playback starts from folder 02.

#### 3 Tap [USB] or [SD] on the left edge of the screen to display the “USB” or “SD” screen.

#### 4 Touch the screen to display the touch panel keys.

#### 5 Use the touch panel keys on the screen to control the external storage device (USB, SD).

- ➔ For details, refer to *Using the touch panel keys (Video)* on the next page. □

### Reading the screen

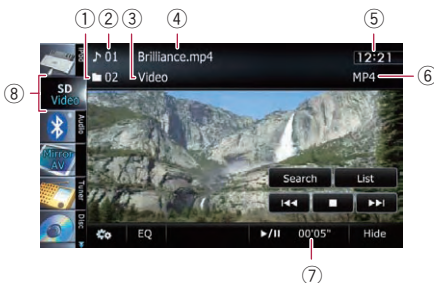

- This unit may not achieve optimum performance with some external storage devices.
- You can playback the files on a USB storage device compliant with Mass Storage Class. For details about the USB Class, refer to the manual supplied with the USB storage device.

#### ① Folder number indicator

#### ② File number indicator

#### ③ Current folder name indicator

Shows the folder name currently playing.

#### ④ File name indicator

Shows the file name currently playing.

#### ⑤ Current time

#### ⑥ File type indicator

Shows the type of audio file currently playing.

#### ⑦ Play time indicator

Shows the elapsed playing time within the current file.

#### ⑧ Source icon

Shows which source has been selected. □

## Using the touch panel keys (Video)

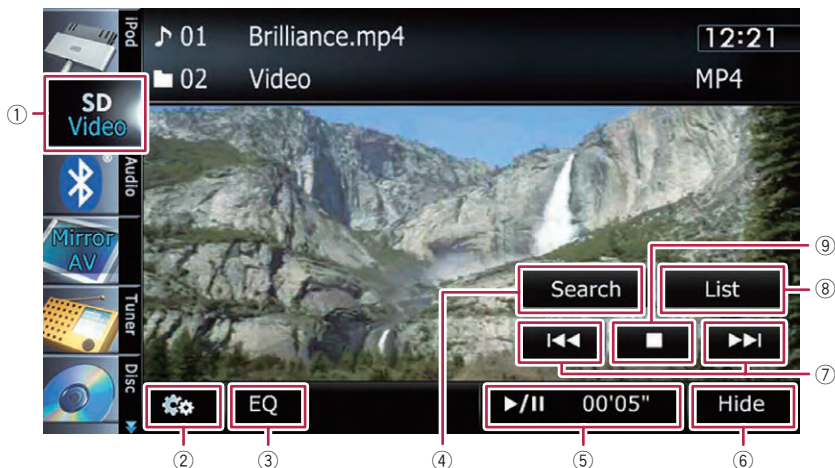

- ① **Switches the operation screen**  
Tapping this key switches between the screen to operate music files and the screen to operate video files. This touch panel key is available only when there are both audio and video files in the external storage device (USB, SD).
- ② **Displays the "Function" menu**  
➔ For details, refer to *Using advanced functions* on the next page.
- ③ **Recalls equalizer curves**  
➔ For details, refer to *Using the equalizer* on page 182.
- ④ **Searches for a desired scene and starts playback from a specified time**  
➔ For details, refer to *Searching for a specific scene and starting playback from a specified time* on the next page.
- ⑤ **Playback and Pause**  
Touching [▶/||] switches between playback and pause.
- ⑥ **Hides the touch panel keys and information of the current video**  
Touching [Hide] shows only the current video.  
 If you want to display the touch panel keys and information of the current video again, touch anywhere on the LCD screen.
- ⑦ **Skips forward or backward**

Touching [▶▶] skips to the start of the next file. Touching [◀◀] once skips to the start of the current file. Touching it twice quickly will skip to the previous file.

**Fast reverse or forward**

Touch and hold [◀◀] or [▶▶] to fast reverse or fast forward.

There is no sound on fast reverse or forward.

⑧ **Selects a file from the list**

You can select and play the title you want from the list.

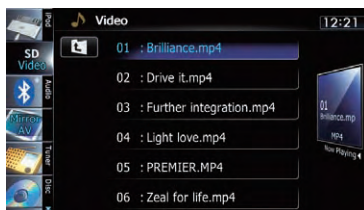

➔ For details, refer to *Operating list screens* (e.g. iPod list screen) on page 74.

The contents of the folder in which the currently playing file is located are displayed. Touching [◀] displays the content of the upper folder (parent folder). If the uppermost folder is listed, [◀] cannot be used.

## Playing video files (from USB or SD)

### ⑨ Stops playback

### Searching for a specific scene and starting playback from a specified time

You can search for a desired scene by specifying the time.

#### 1 Touch [Search].

#### 2 Touch the keys to input the target number or time and then touch [Enter].

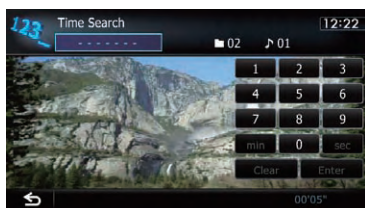

- To select 5 minutes 3 seconds, touch [5], [min], [3], [sec] and [Enter] in order.
- To select 71 minutes 00 seconds, touch [7], [1], [min] and [Enter] in order.
- To select 100 minutes 05 seconds, touch [1], [0], [0], [5], [sec] and [Enter] in order.
- To cancel an input number, touch [Clear].  
To cancel the input numbers, touch and hold [Clear].

## Operating by hardware buttons

### Pressing the TRK button

You can skip files forward or backward.

### Pressing and holding the TRK button

You can perform fast reverse or fast forward. 

## Using advanced functions

### 1 Tap [USB] or [SD] on the left edge of the screen to display the "USB" or "SD" screen.

- ☞ For details of the operations, refer to *Dis playing the AV operation screen* on page 74.

### 2 Touch the screen to display the touch panel keys.

### 3 Touch .

The "Function" menu appears.

- If the touch panel keys are not shown, touch anywhere on the screen to display them.

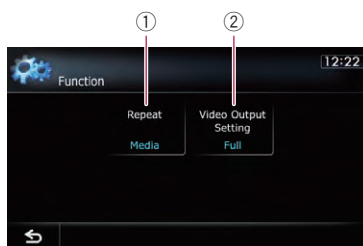

#### ① Changes the repeat range

Each touch of [Repeat] changes the setting as follows:

- **Media:** Repeats all video files in the selected external storage device (USB, SD).
- **File:** Repeats just the current file.
- **Folder:** Repeats the current folder.
- If you skip the file forward or backward when the repeat play range in "File", the repeat play range changes to "Folder".

#### ② Changes the screen size of video

If a video file is played, you can select the display mode between normal and full screen.

Each touch of [Video Output Setting] changes the setting as follows:

- **Normal:** Enlarges the display size while maintaining the aspect ratio.
- **Full:** Displays the image full screen although the aspect ratio may be changed. 

Using the USB interface cable for iPod enables you to connect your iPod to the navigation system.

- ❑ A USB interface cable for iPod (CD IU51V) (sold separately) is required for connection.

## Starting procedure

### 1 Display the AV operation screen.

- ➔ For details of the operations, refer to *Displaying the AV operation screen* on page 74.

### 2 Connect your iPod.

The source changes and then playback will start.

- ➔ For details, refer to *Connecting your iPod* on page 22.
- ❑ If the iPod is already connected, tap [iPod] on the left edge of the screen.
  - ➔ For details, refer to **Selecting a source** on page 74.
- ❑ If you connect the iPhone or iPod touch, quit applications before connecting.
- ❑ If no video is output when iPod is selected as AV source, check the setting in **AV1 Input** on the **AV System Settings** menu.
  - ➔ For details, refer to *Setting video input 1 (AV1)* on page 177.

### 3 Use the touch panel keys on the screen to control your iPod.

- ➔ For details of the operation, refer to *Using the touch panel keys* on page 122. 

## Reading the screen

### Music

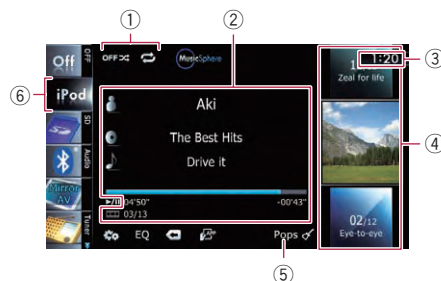

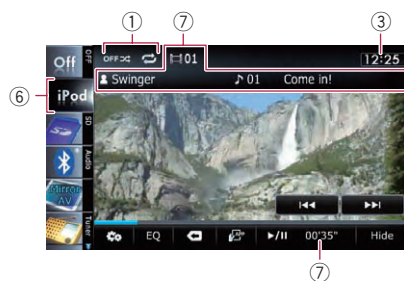

### Video



### ① Playback condition indicator

Indicates the current playback condition.



### Setting the shuffle play

Indicator	Meaning
	Cancels the shuffle play.
	Plays back songs or videos in random order within the selected list.
	Selects an album randomly, and then plays back all songs in that album in order. The actions while this indicator is displayed on the video operation screen vary depending on the connected iPod.



## Using an iPod (iPod)

### Setting a repeat play range

Indicator	Meaning
	Repeats all songs or videos in the selected list.
	Repeats just the current song or video.

### ② Current song (episode) information

- : **Artist name (podcast title)**

Shows the artist name currently playing. When a podcast is played, the podcast title is displayed (when available).

- : **Album title (release date)**

Shows the title of the album for the song. When a podcast is played, the release date is displayed (when available).

- : **Song title (episode)**

Shows the title of the current song. When a podcast is played, the episode is displayed (when available).

- : **Chapter number**

Shows the current chapter number and total number of chapters when the file with chapters played (when available).

- **Play time**

Shows the elapsed playing time within the current song (episode).

- "-----" is displayed if there is no corresponding information.

### ③ Current time

### ④ Song (episode) information

- **Song number indicator**

Shows the number of the song and the total number of songs in the selected list.

- **Song title (episode) indicator**

- **Album artwork**

Album art of the current song is displayed if it is available.

### ⑤ Genre indicator

Shows the genre of the current song.

### ⑥ Source icon

Shows which source has been selected.

### ⑦ Current video information

- : **Chapter number**

Shows the current chapter number when the video with chapters played (when available).

- : **Artist name (podcast title)**

Shows the artist name currently playing. When a podcast is played, the podcast title is displayed (when available).

- : **File number indicator**

Shows the number of the file currently playing (when available).

- **File name indicator**

Shows the file name currently playing (when available).

- **Play time indicator**

Shows the elapsed playing time within the current file.

- "-----" is displayed if there is no corresponding information.

- If characters recorded on the iPod are not compatible with this navigation system, they may turn into garbled characters. □

## Using the touch panel keys

### Music



### Video

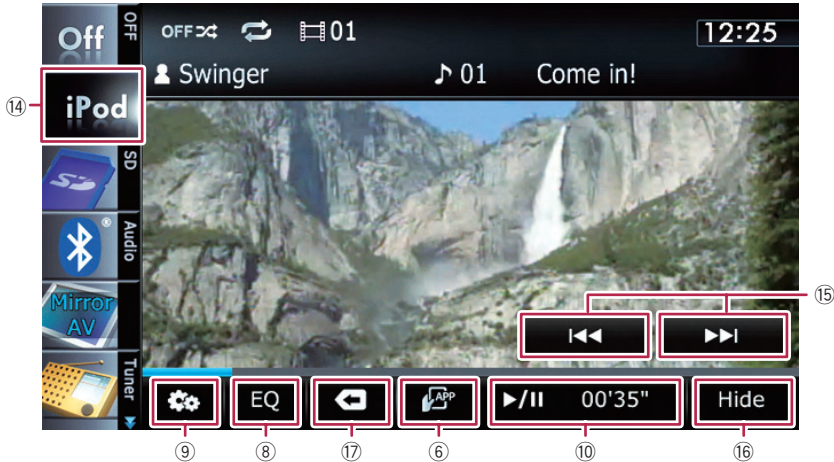

- ① **Sets the shuffle play for music**  
The shuffle play setting can be changed by touching only one key.  
➔ For details, refer to **Sets the shuffle play for music** on page 129.
- ② **Sets a repeat play range**

The repeat play range can be changed by touching only one key.

➔ For details, refer to **Sets repeat play** on page 129.

- ③ **Displays the “MusicSphere” screen**

## Using an iPod (iPod)

Touching the key displays the **MusicSphere** screen, and a playlist created with the PC application (**MusicSphere**) can be played.

➔ For details, refer to *Playing MusicSphere* on page 129.

### ④ Selects a song to play

Scrolling the keys up or down displays songs, and tapping a song starts playback.

Tapping the lower key during shuffle playback skips to the next song. Tapping the upper key once skip to the start of the current song. Tapping it again will skip to the previous song. When the song with chapters played, chapter can be skipped back and forward.

### ⑤ Displays the genre list

### ⑥ Switches the control mode of iPod functions

Touching the key lets you control the functions of an iPod connected to the navigation system from the iPod.

➔ For details, refer to *Operating the functions from your iPod* on page 128.

### Displays the operation screen of application for iPhone

➔ For details, refer to *Operating an application for iPhone from the navigation system* on page 126.

### ⑦ Displays the top category menu

Touching the key displays the top category for song playback.

### Displays the previously selected list

If you select the song from the list to play after touching , touching the key displays the previous list.

### ⑧ Recalls equalizer curves

➔ For details, refer to *Using the equalizer* on page 182.

### ⑨ Displays the "Function" menu

➔ For details, refer to *Using advanced functions* on page 129.

### ⑩ Playback and Pause

Touching  switches between playback and pause.

### ⑪ Displays the song list

### ⑫ Displays the album list

### ⑬ Displays the artist list

### ⑭ Displays the top category menu

Touching the key displays the top category menu for song or video playback.

### Switches the operation screen



Tapping this key displays the touch panel key (**[Video]** or **[Music]**) to switch between the screen to operate video files and the screen to operate music files.

➔ For details of the operation, refer to *Starting the video playback* on the next page.

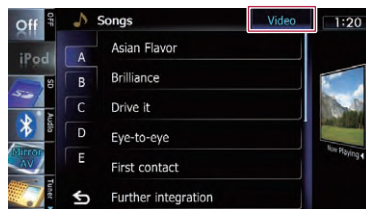

- ❑ This touch panel key is available only when there are both audio and video file in your iPod.
- ❑ Touching **[Video]** or **[Music]** on the list screens enables you to perform the equivalent operation.







### ⑮ Skips back or forward to another video

Touching  skips to the start of the next video. Touching  once skips to the start of the current video. Touching again will skip to the previous video. When the video with chapters played, chapter can be skipped back and forward.

### Fast reverse or forward

Touch and hold  or  to fast reverse or fast forward.

If you keep touching  or  for five seconds, fast reverse/fast forward continues even if you release either of these keys. To resume playback at a desired point, touch ,  or .

### ⑯ Hides the touch panel keys and information of the current video



Touching **[Hide]** shows only the current video.

- ❑ If you want to display the touch panel keys and information of the current video again, touch anywhere on the LCD screen.

### 17 Displays the top category menu for video

Touching the key displays the top category for video playback.

#### Displays the previously selected list

If you select the video from the list to play after touching , touching the key displays the previous list. .

## Operating by hardware buttons

### Pressing the TRK button

You can skip songs, videos or podcasts forward or backward.

When the song, video or podcast with chapter played, you can skip chapter forward or backward.

### Pressing and holding the TRK button

You can perform fast reverse or fast forward. .

## Starting the video playback

This navigation system can play video if an iPod with video capabilities is connected.

1 Touch [iPod] on the left edge of the screen to display the touch panel key to switch to a video source.

2 Tap [Music].

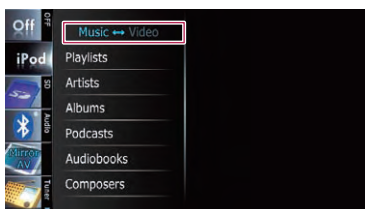

A list of videos by category appears.

3 Tap one of the categories in that contains the video you want to play.

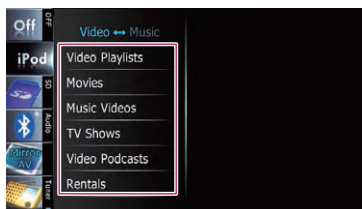

4 Tap your desired item on the list to narrow down them until the video list appears.

➤ For details, refer to *Narrowing down a song or video with the list* on this page.

5 On the video list, tap the video you want to play.

Video playback will start.

6 Touch the screen to display the touch panel keys.

➤ For details of the operation, refer to *Using the touch panel keys* on page 122. .

## Narrowing down a song or video with the list

Tapping an item on list allows you to search for a song or video and play it in your iPod.

1 Display a list screen.

➤ For details, refer to *Displays the genre list* on the previous page.

➤ For details, refer to *Displays the song list* on the previous page.

➤ For details, refer to *Displays the album list* on the previous page.

➤ For details, refer to *Displays the artist list* on the previous page.

■ If you touch , the top category menu screen is displayed. Tap the category of your preference.

## Using an iPod (iPod)

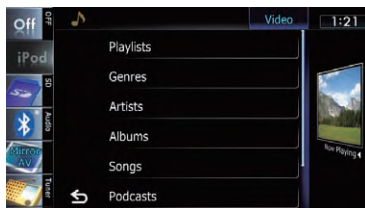

**2 Scroll by dragging tabs up or down to display the character that you want to refine.**

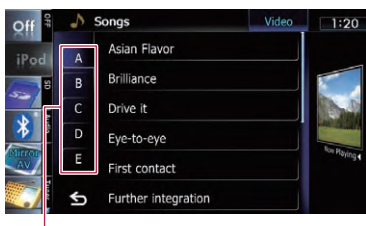

Character tabs

**3 Tap the tab to select the character and display the page which includes applicable options.**

- An article listed below and space at the beginning of the artist name will be ignored and the next character will be taken into account for searching.
  - "A" or "a"
  - "AN", "An", or "an"
  - "THE", "The", or "the"



**4 Scroll the list by dragging items up or down to display the item you want to select.**

Refine the item until the song title (episode) is displayed on the list.

- Tapping **[All]** on the list includes all options in the current list. For example, if you tap **[All]** after tapping **[Artists]**, you can proceed to the next screen with all artists in the list selected.
- After you select artists, albums, genres, podcasts, or composers, go on to touch and hold one of the list to start playing the

first song in the selected list and display the next hierarchy.

**5 On the song (episode) or video list, tap the song (episode) or video you want to play.**

- After you select the song (episode) or video using this function, touching  displays the list previously selected. 

## Operating an application for iPhone from the navigation system

This navigation system can switch to the **Advanced App Mode**, which you can display and operate the application for iPhone on the screen.

In **Advanced App Mode**, you can operate applications with finger gestures such as tapping, dragging, scrolling or flicking on the screen of the navigation system.

- ❑ Be sure to read *Using app based connected content* before you perform this operation.
  - For details, refer to *Using app based connected content* on page 223.

- Pioneer is not liable for any issues that may arise from incorrect or flawed app based content.
- The content and functionality of the supported applications are the responsibility of the App providers.
- In Advanced App Mode, functionality through the product is limited while driving, with available functions determined by the App providers.
- Availability of Advanced App Mode functionality is determined by the App provider, and not determined by Pioneer.
- Advanced App Mode allows access to applications other than those listed (subject to limitations while driving), but the extent to which content can be used is determined by the App providers.

This function can be operated with the following iPhone models:

- iPod touch 4th generation
  - iPhone 4S
  - iPhone 4
- ❑ Applications operable by switching this navigation system to **Advanced App Mode** are only those available for **Advanced App Mode**.  
Please check iPhone applications supported Advanced App Mode at

<http://www.pioneerelectronics.com/AppRadio>

- ❑ The compatible finger gestures vary depending on the application for iPhone.

## Starting procedure

### 1 Display the operation screen of the iPhone.

- For details of the operation, refer to *Starting procedure* on page 120.

### 2 Start an application available for Advanced App Mode from the iPhone.

An image of the application is displayed on the screen of this navigation system.

- ❑ You can start an application available for **Advanced App Mode** also from a launcher application.

### 3 Touch to hide the AV source icons or wait until the source icons disappear.

- ❑ If the source icons are displayed, you can not conduct the operation of application on the screen.

### 4 Operate the application.

### 5 Touch the key to go back to the operation screen of the iPhone.

## Using the touch panel keys

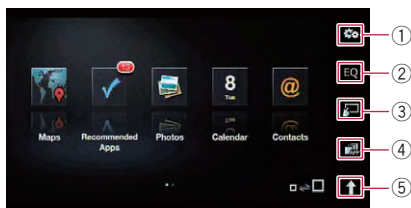

#### ① Displays the "Function" menu

#### ② Recalls equalizer curves

- For details, refer to *Using the equalizer* on page 182.

#### ③ Switches to the normal mode

- Tapping the key displays the operation screen of iPhone.

## Using an iPod (iPod)

### ④ Starts the AppRadio app

Tapping the key starts **AppRadio app**, which is a launcher application for applications available for **Advanced App Mode**.

❑ To use the **AppRadio app** in this navigation system, install the application to the iPhone in advance.

For details about the **AppRadio app**, visit the following site:

<http://www.pioneerelectronics.com/AppRadio>

❑ In some iPhone modes, selecting a source may start up an application for iPhone. If the message "**Start up the application from your Device.**" appears, start up the application from your iPhone.

### ⑤ Displays the AV source icons

Tapping the key shows the AV source icons.

❑ If you touch **⏮**, **⏪** switches to **⏸**. If you touch **⏸**, the AV source icons are hidden and **⏸** switches to **⏮**.

## Using the keyboard

### ⚠ CAUTION

For your safety, the keyboard functionality is only available when the vehicle is stopped and the parking brake is engaged.

❑ Keyboard is available only in **Advanced App Mode**.

When you tap a text input area of an application for iPhone, a keyboard will be displayed on screen. You can input the desired text directly from this navigation system.

❑ The language preference for the keyboard of this navigation system should be same as the setting on your iPhone. If the settings for this product and the iPhone are different, you may not be able to enter characters properly.

### 1 Set language preference for the keyboard of the iPhone.

### 2 Display the operation screen of the iPhone.

➤ For details of the operation, refer to *Starting procedure* on page 120.

### 3 Touch **⏮**.

### 4 Touch **⏮**.

The "Function" menu appears.

### 5 Touch [Keyboard].

The "Select Keyboard" screen appears.

### 6 Touch the desired language.

After the language is selected, the previous screen returns.

### 7 Tap the text input area on the application screen of the iPhone.

The keyboard for entering the text appears.

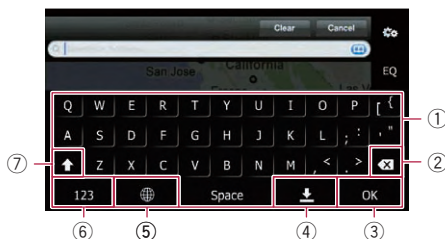

① Enters the characters

② Deletes the input text one letter at a time, beginning at the end of the text

③ Confirms the entry and allows you to proceed to the next step

④ Hides the keyboard and text can now be entered using the keyboard of iPhone

⑤ Changes the iPhone keyboard layout

❑ The iPhone keyboard layouts that can be selected by tapping **⌐** depends on the setting of Hardware Keyboard Layout of your iPhone.

⑥ Switches to a keyboard offering numeric and symbol characters

⑦ Converts the case of the keyboard characters

## When using an application not compatible with Advanced App Mode

When an application not compatible with **Advanced App Mode** is started, depending on the application, you can operate it with the touch panel key displayed. However, the behavior when touching the key depends on the application.

Also, the display of images on the screen of this navigation system depends on the application.

### 1 Display the operation screen of the iPhone.

- For details of the operation, refer to *Starting procedure* on page 120.

### 2 Touch .

The operation of music or video sources is switched to your iPhone.

### 3 Start an application from the iPhone.

### 4 Touch the key to go back to the operation screen of the iPhone. .

## Operating the functions from your iPod

You can switch operation of the music or video sources to your iPod.

- ❑ The following operations can be performed from the navigation system even if other operations are performed from your iPod.
  - Playback and Pause
  - Fast reverse or forward
  - Skip forward or backward
  - Adjusting the volume
- ❑ Sound is output from the speakers of your vehicle even if the iPod operations is performed from your iPod.

## Starting procedure

### 1 Display the operation screen of the iPod.

- For details of the operation, refer to *Starting procedure* on page 120.

### 2 Touch .

The operation of music or video sources is switched to your iPod.

### 3 Operate the music or video sources with iPod.

### 4 Touch the key to go back to the operation screen of the iPod.

## Using the touch panel keys



#### ① Displays the "Function" menu

#### ② Recalls equalizer curves





- For details, refer to *Using the equalizer* on page 182.

#### ③ Switches to the normal mode

Tapping the key displays the operation screen of iPod.

#### ④ Hides the AV source icons

Tapping the key shows only the current image.

- ❑ If you touch ,  switches to . If you touch , the AV source icons are displayed and  switches to .

#### ⑤ Operates the iPod

The operations activated by touching vary depending on the connected iPod. .



## Using an iPod (iPod)

### Playing MusicSphere

You can play playlists created with the PC application (**MusicSphere**) using an exciting graphic interface.

- PC application (**MusicSphere**) will be available on our website.

### Starting procedure

#### 1 Display the music operation screen of the iPod.

- ➔ For details of the operation, refer to *Starting procedure* on page 120.

#### 2 Touch .

- ➔ For details of the operations, refer to *Displays the "MusicSphere" screen* on page 122.

### Reading the screen



#### ① Category name and total number of songs

Shows the category name and the total number of playable songs in the playlist currently selected.

#### ② Song title indicator

Shows six songs including the first song played after selecting the playlist.

#### ③ Playlist name indicator

Shows the name of the playlist currently selected.

#### ④ Current time

#### ⑤ Category name

Shows the category name in the playlist.

### Using the touch panel keys



①

#### ① Switches to the AV operation screen

#### ② Plays the playlist

Tapping a key moves the playlist to the center of the screen, and tapping the center key starts playback.

- To change the playlist to be displayed, rotate the sphere by dragging the keys up, down, left, or right. □

### Using advanced functions

- Touch  on the "iPod" screen.

The "Function" menu appears.

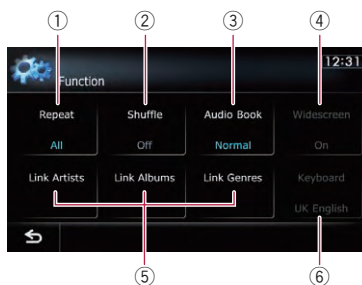

#### ① Sets repeat play

There are two repeat play types for playback.

Each touch of [Repeat] changes the setting as follows:

- **All:** Repeats all songs or videos in the selected list.
- **One:** Repeats just the current song or video.

#### ② Sets the shuffle play for music

This function shuffles songs or albums and plays them in random order.

Each touch of [**Shuffle**] changes the setting as follows:

- **Off:** Does not shuffle.
- **Songs:** Plays back songs or videos in random order within the selected list.
- **Albums:** Selects an album randomly, and then plays back all songs in that album in order.

### ③ Sets the audiobook play speed

While listening to an audiobook on iPod, playback speed can be changed.

Each touch of [**Audio Book**] changes the setting as follows:

- **Normal:** Playback in normal speed
- **Faster:** Playback faster than normal speed
- **Slower:** Playback slower than normal speed

### ④ Plays video in wide screen mode

If the video is compatible with wide screen format, set "**Widescreen**" to "**On**" in order to view the video image in the wide screen. Each touch of [**Widescreen**] changes the setting as follows:

- **On:** Outputs the wide screen video from an iPod.
- **Off:** Outputs the normal sized video from an iPod.
- Display size is changed after you change "**Widescreen**" setting and select the video to play.
- This setting is available only during the video operation.

### ⑤ Plays songs related to the currently playing song

You can play songs related to the currently playing song, using of the following lists.

- **Link Artists:** Songs related to the currently playing artist will be played in the album order.
- **Link Albums:** Songs related to the currently playing album will be played.
- **Link Genres:** Songs related to the currently playing genre will be played in the artist order.

### ⑥ Selects the display language of the keyboard

You can select the display language of the keyboard used in **Advanced App Mode**.

- This setting is available only when you change the screen of the navigation system to the screen of the application for iPhone.

## Using smartphone applications

When connecting smartphone with applications installed, you can control, view, and/or hear application content from this navigation system.

❑ In this chapter, iPhone and iPod touch will be referred to as iPhone.

In this navigation system, you can use the following applications.

- Pandora® internet
  - Aha Radio
- ❑ Be sure to read *Using app based connected content* before you perform this operation.
- ➔ For details, refer to *Using app based connected content* on page 223.
- ❑ Even if you switch to another source while listening to Aha Radio contents, playback of the contents continues when you switch back to the Aha Radio source.
- ❑ When you are talking on a cellular phone connected to this navigation system via Bluetooth wireless technology, playback content is paused temporarily. Playback resumes when you finish talking.

### Information for the smartphone compatibility

The following devices can use this function.

- iPhone and iPod touch
- Android™ device
- BlackBerry® device

The following applications are supported by the respective smartphones.

	iPhone	Android	BlackBerry
Pandora® internet	✓	✓	✓
Aha Radio	✓	✓	

Followings are the detailed information regarding the terminals required to use the Aha Radio application on this navigation system.

#### For iPhone users

- The device has iOS 3.0 or higher.

- USB interface cable for iPod (CD IU51V) (sold separately) is required to connect your iPhone to this navigation system.

#### For Android device users

- The following conditions apply to use of this function.
  - The device has Android OS 2.2 or higher.
  - The device supports Bluetooth SPP (Serial Port Profile).
- ❑ Compatibility with all Android devices is not guaranteed.
  - For details about Android device compatibility with this navigation system, refer to the information on our website.
- The device is connected to this navigation system via Bluetooth.

#### For BlackBerry device users

- The following conditions apply to use of this function.
  - The device has BlackBerry OS 4.3 or higher.
  - The device supports Bluetooth SPP (Serial Port Profile).
- ❑ Compatibility with all BlackBerry devices is not guaranteed.
  - For details about BlackBerry device compatibility with this navigation system, refer to the information on our website.
- The device is connected to this navigation system via Bluetooth. ❑

### Starting procedure

The procedure varies depending on your type of smartphone.

## For Android device and BlackBerry device users

### 1 Register the device in this navigation system.

- When registering the device, you must select either "**Handsfree and Audio**" or "**Audio**".
- The registered device must be selected as the priority device.
  - ➔ For details, refer to *Registering your Bluetooth devices* on page 59.

### 2 Display the "AV System Settings" screen.

- ➔ For details, refer to *Displaying the screen for AV system settings* on page 177.

### 3 Touch [App Connection] and set to "Bluetooth".

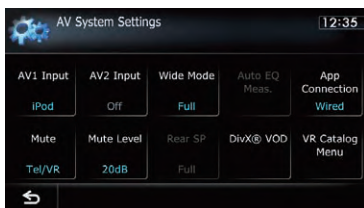

- This key is not available when an Aha Radio source has already been selected.

### 4 Display the AV operation screen.

- ➔ For details of the operations, refer to *Displaying the AV operation screen* on page 74.

### 5 Tap [Pandora] or [aha] on the left side of the screen to display "Pandora" or "aha" screen.

When you tap [Pandora] or [aha], the navigation system attempts to establish the Bluetooth connection.

After the connection is successfully established, the touch panel keys on the "Pandora" or "aha" screen are activated.

- ➔ For details, refer to **Selecting a source** on page 74.

### 6 Use the touch panel keys on the screen to control the Pandora or Aha Radio.

- ➔ For details, refer to *Using Pandora® internet radio* on the next page.
- ➔ For details, refer to *Using Aha Radio* on page 135.

## For iPhone users

### 1 Display the "AV System Settings" screen.

- ➔ For details, refer to *Displaying the screen for AV system settings* on page 177.

### 2 Touch [App Connection] and set to "Wired".



- This key is not available when an Aha Radio source has already been selected.

### 3 Start up the Pandora or Aha application installed on the iPhone.

- In some iPhone modes, selecting a source may start up an iPhone application. If the message "**Start up the application from your Device.**" appears, start up the application from your iPhone.
- Before starting up, sign in to Pandora from your iPhone.

### 4 Display the AV operation screen.

- ➔ For details of the operations, refer to *Displaying the AV operation screen* on page 74.

### 5 Connect your iPhone.

The source changes and then playback will start.

- ➔ For details, refer to *Connecting your iPod* on page 22.

## Using smartphone applications

- If the iPod is already connected, tap [Pandora] or [aha] on the left edge of the screen.
- ➔ For details, refer to **Selecting a source** on page 74.

**6 Tap [Pandora] or [aha] on the left side of the screen to display “Pandora” or “aha” screen.**

**7 Use the touch panel keys on the screen to control the Pandora or Aha Radio.**

- ➔ For details, refer to *Using Pandora® internet radio* on this page.
- ➔ For details, refer to *Using Aha Radio* on page 135. □

### Using Pandora® internet radio

You can experience Pandora by connecting an smartphone that has the Pandora application installed.

#### Note:

- Certain functionality of the Pandora service is not available when accessing the service through the Pioneer navigation system, including, but not limited to, creating new stations, deleting stations, emailing current stations, buying songs from iTunes, viewing additional text information, logging in to Pandora, and adjusting Cell Network Audio Quality.
- Pandora internet radio is a music service not affiliated with Pioneer. More information is available at <http://www.pandora.com>
- To insure compatibility, install the latest version of the Pandora® internet radio application by navigating to [www.pandora.com](http://www.pandora.com) on your mobile device.

### Reading the screen

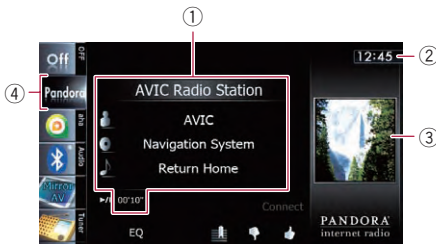

#### ① Current song information

- **Station name indicator**  
Shows the Pandora station name the tuner is currently tuned in.
- **Artist name**  
Shows the artist name currently playing.
- **Album title**  
Shows the title of the album of the current track.
- **Track title**  
Shows the title of the current track.
- **Play time indicator**  
Shows the elapsed playing time within the current track.
  - “-----” is displayed if there is no corresponding information.

#### ② Current time

#### ③ Album artwork

Album art of the current track is displayed if it is available.

#### ④ Source icon

Shows which source has been selected.

## Using the touch panel keys

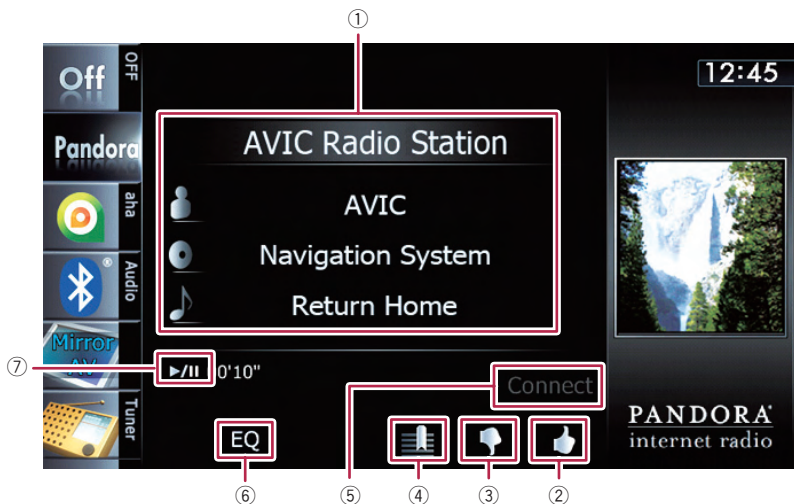

## ① Selects a Pandora station from the list



Touching the key displays the list of your Pandora stations to select one of them to play.



➔ For details, refer to *Operating list screens* (e.g. *iPod list screen*) on page 74.

Scroll the list by dragging items up or down to display the item you want to select.

- Touching [QuickMix] plays only one track based on particular musical characteristics at a time from shuffled several stations.
- Stations indicated by  are shared stations.
- Each time you touch [List] changes the sort order. Current order is indicated on the upper right of the screen.

- : You can sort the items in the list alphabetically.
- : You can sort the items in the list in order of dates the items were created.

## ② Thumbs Up

Touching the key gives "Thumbs Up" to the track currently playing.

- This function is not available when using a shared station.

## ③ Thumbs Down

Touching the key gives "Thumbs Down" to the track currently playing and skip to the next track.

- This function is not available when using a shared station.

## ④ Bookmark

Touching the key displays the screen which lets you select the artist or track to add book marks.

## ⑤ Connecting a registered Bluetooth device manually

- This is displayed when "App Connection" is set to "Bluetooth".

➔ For details, refer to *Starting procedure* on page 131.

## Using smartphone applications

- ⑥ **Recalls equalizer curves**  
 ➔ For details, refer to *Using the equalizer* on page 182.
- ⑦ **Playback and Pause**  
 Touching [▶/II] switches between playback and pause.

### Operating by hardware buttons

#### Pressing the TRK button

You can skip the track forward. 

### Using Aha Radio

When connecting iPod with the Aha Radio installed, you can control, view, and/or hear Aha Radio content from this navigation system. You can also display POI information from the Aha Radio application on the map screen and route to these POIs.

- ❑ For details concerning operations, refer to the Help and Tips section within the Aha Radio application.
- ❑ Aha Radio stations may require initial setup or sign in before the station can be accessed.

#### Note:

- Certain functionality of the Aha Radio service may not be available when accessing the service through the Pioneer navigation system, including, but not limited to, creating new Aha stations, deleting Aha stations, recording 'shouts' by voice, adjusting Aha Radio App settings, logging into Facebook, creating a Facebook account, logging into Twitter, or creating a Twitter account.
- Aha Radio is a service not affiliated with Pioneer. More information is available at <http://www.ahamobile.com>.
- A specific version of the Aha Radio application is required to be installed on your smartphone in order to enjoy Aha Radio content on this navigation system.
- Because the application for the smartphone is not provided by Pioneer, the required version of the application may not yet be available at the time of purchase of the navigation system.

Availability, version and update information can be found at <http://www.pioneerelectronics.com/aharadio>

### Reading the screen

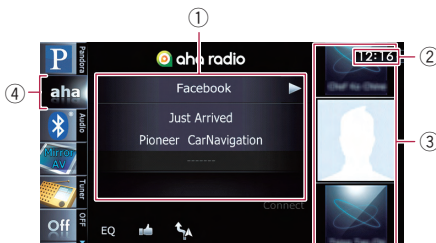

- ① **Current station information**  
 Shows which source has been selected.
- **Station name**  
 Shows the name of the Aha Radio station that the navigation system is currently tuned to.
  - **Detailed information**  
 Shows the information on the content currently being played.  
 ❑ "-----" is displayed if there is no corresponding information.
  - **Rating information**  
 Shows the rated value of the current content displayed (only when and where applicable).

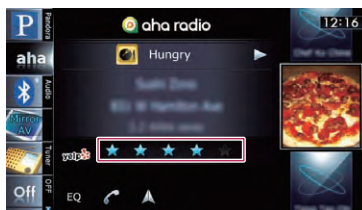

- ② **Current time**
- ③ **Content image**  
 Displays an image of the current content if one is available.
- ④ **Source icon**  
 Shows which source has been selected.

## Using the touch panel keys

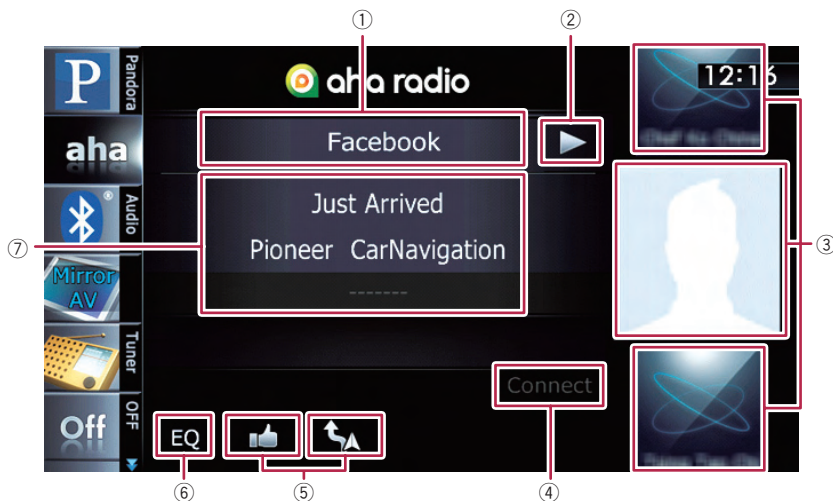

① **Selects an Aha Radio station from the list**

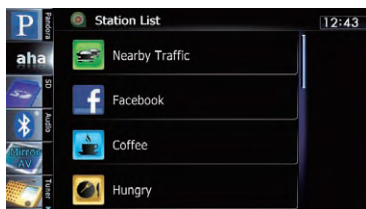

Touching this key displays the list of your available Aha Radio stations. Touch the desired Aha Radio station to change Aha sources.



➡ For details of the list operations, refer to *Operating list screens (e.g. iPod list screen)* on page 74.

Scroll the list by dragging items up or down to display the item you want to select.

② **Playback and pause (or stop)**

Touch  to start playback. Touching  during playback, pauses or stops playback.

Pause (or stop) key functionality depends on the content.

③ **Selects content to play**

Scrolling the keys up or down displays available content while tapping a key starts playback.





④ **Connecting a registered Bluetooth device manually**

This is displayed when "App Connection" is set to "Bluetooth".

➡ For details, refer to *Starting procedure* on page 131.









⑤ **Performs additional functions of each station or content currently playing**

The icons displayed vary depending on each station or content.

Indicator	Meaning
	Touching the key discloses the current car location through Aha Radio.
	Touching the key retweets the selected tweets with your Twitter account.
	Touching the key performs fast reverse of the current content for 30 seconds.
	Touching the key sends you to the Location confirmation screen the selected POI to search for the desired route. ➡ For the subsequent operations, refer to <i>Setting a route to your destination</i> on page 45.



## Using smartphone applications

Indicator	Meaning
	Touching the key "likes" current content. <input type="checkbox"/> Depending on the content, touching  or  cancels "likes".
	Touching the key "dislikes" current content. <input type="checkbox"/> Depending on the content, touching  or  cancels "dislikes".
	Touching the key unsubscribes the selected content. The unsubscribed content will be deleted from the My Feeds station.
	Touching the key follows the current content. The followed content will be added to the My Feeds station.
	Touching the key lets you make a call to a phone number registered in the current content using the hands free function.

### ⑥ Recalls equalizer curves

➔ For details, refer to *Using the equalizer* on page 182.

### ⑦ Pauses the content currently playing and shows a text pop-up screen

"-----" is displayed if there is no corresponding information.

Pop up screen

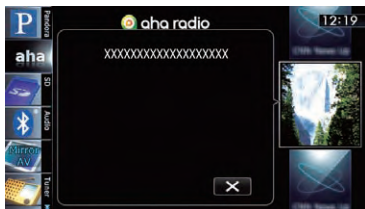

Touching  closes the pop up screen and plays the content.

## Displaying POIs obtained with Aha Radio

If you select a station with content that includes POI location information, the corresponding POI icons will appear on the map screen. A maximum of 30 POI icons are displayed at one time.



Detailed information can be displayed by placing the scroll cursor over the POI icon.

➔ For details, refer to *Viewing information about a specified location* on page 32.

The POI icons on the map will not disappear even when the iPod is removed. The icons will disappear with the following operations:

- Turning off the ignition switch (ACC OFF)
- Initializing user data
- Updating the display of the Aha POI icons

Aha POI icons are updated at the following intervals.

- When a station with content including location information is reselected
- When the content lists of the Aha application are updated
- If there are 30 or more content items selected and 31st POI is read

## Functions coupled with Aha Radio and the navigation system

Depending on the stations, functions coupled with the navigation system are available.

You can control the Bluetooth audio player.

- ❑ Before using the Bluetooth audio player, you need to register and connect the device to this navigation system.
  - ➔ For details, refer to *Registering your Bluetooth devices* on page 59.
- ❑ Operations may vary depending on the kind of a Bluetooth audio player.
- ❑ Depending on the Bluetooth audio player connected to this navigation system, the available operations with this navigation system are limited to the following two levels:
  - A2DP profile (Advanced Audio Distribution Profile): Only playing back songs on your audio player is possible.
  - A2DP profile and AVRCP profile (Audio/Video Remote Control Profile): Playing back, pausing, selecting songs, etc., are possible.
- ❑ Since there are a number of Bluetooth audio players available on the market, operations with your Bluetooth audio player using this navigation system vary greatly in range. Please refer to the instruction manual that came with your Bluetooth audio player as well as this manual while operating your player on this navigation system.
- ❑ While you are listening to songs on your Bluetooth audio player, please refrain from operating your cellular phone as much as possible. If you try operating on your cellular phone, the signal from your cellular phone may cause a noise on the song playback.
- ❑ Even if you switch to another source while listening to a song on your Bluetooth audio player, the playback of song continues to elapse.
- ❑ Depending on the Bluetooth audio player you connected to this navigation system, operations on this navigation system to control the player may differ from those explained in this manual.
- ❑ When you are talking on a cellular phone connected to this unit via Bluetooth wireless technology, song playback from your Bluetooth audio player connected to this unit may be paused.

## Starting procedure



- 1 **Display the AV operation screen.**
  - ➔ For details of the operations, refer to *Displaying the AV operation screen* on page 74.
- 2 **Tap [Audio] on the left edge of the screen to display the "Audio" screen.**
- 3 **Use the touch panel keys on the screen to control the Bluetooth audio player.**
  - ➔ For details, refer to *Using the touch panel keys* on page 140. 

## Reading the screen





- 1 **Playback condition indicator**  
Indicates the current playback condition if the connected Bluetooth audio player features AVRCP 1.3.

### Playing files in random order

Indicator	Meaning
	Does not play files in random order.
	Plays all audio files in the current repeat play range in random order.



### Setting a repeat play range

Indicator	Meaning
	Does not repeat.
	Repeats just the current file.
	Repeats all audio files in the Bluetooth audio player.

- 2 **Current file information**

## Using the Bluetooth audio player

If the connected Bluetooth audio player features AVRCP 1.3, the following file information will be displayed.

- ** Artist name**  
Shows the artist name currently playing (when available).
  - ** Album title**  
Shows the title of the album of the current file (when available).
  - ** Track title**  
Shows the title of the track currently playing (when available).
  - **Play time indicator**  
Shows the elapsed playing time within the current file.
  - **File number indicator**  
Shows the file number currently playing (when available).
- In the following cases, file information will only be displayed after a file starts or resumes playing:
- You connect the Bluetooth audio player compatible with AVRCP1.3, and operate the player to start playing.
  - You select another file when play back is paused.

③ **Current time**

④ **Source icon**

Shows which source has been selected.

⑤ **Device name indicator**

⑥ **Connection status indicator**

Shows whether the device featuring Bluetooth technology is connected or not.

## Using the touch panel keys



### ① Plays files in random order

All of the files within the repeat play range can be played at random by touching only one key.

☐ This function is available only when the connected Bluetooth audio player features AVRCP 1.3.

➔ For details, refer to **Plays files in random order** on the next page.

### ② Sets a repeat play range

The repeat play range can be changed by touching only one key.

☐ This function is available only when the connected Bluetooth audio player features AVRCP 1.3.

➔ For details, refer to **Changes the repeat range** on the next page.

### ③ Playback and Pause

Touching [▶] or [⏸] switches between play back and pause.

### ④ Connects the Bluetooth audio player

Touching [Connect] displays the connection standby screen and the navigation system waits for the Bluetooth wireless connection request.

### ⑤ Recalls equalizer curves

➔ For details, refer to *Using the equalizer* on page 182.

### ⑥ Displays the “Function” menu

➔ For details, refer to *Using advanced functions* on the next page. ☐

## Operating by hardware buttons

### Pressing the TRK button

You can skip files forward or backward.

### Pressing and holding the TRK button

You can perform fast reverse or fast forward. ☐

## Using the Bluetooth audio player

### Using advanced functions

- ❑ This menu is available only when the connected Bluetooth audio player features AVRCP 1.3.

- Touch  on the "Audio" screen.

The "Function" menu appears.

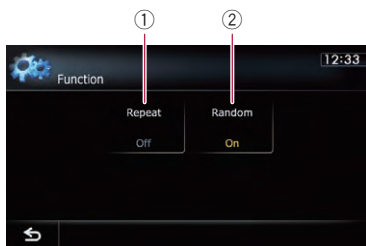

#### ① Changes the repeat range

Each touch of [Repeat] changes the setting as follows:

- **All:** Repeats all audio files in the Bluetooth audio player.
- **Track:** Repeats just the current file.
- **Off:** Does not repeat.

- ❑ If you skip the file forward or backward when the repeat play range in "Track", the repeat play range changes to "All".

#### ② Plays files in random order

Random play lets you playback files in random order within the current repeat range.

Each touch of [Random] turns it on or off. 

You can use the navigation system to control an XM satellite digital tuner, which is sold separately.

For details concerning operation, refer to the XM tuner's operation manuals. This section provides information on XM operations with the navigation system which differs from that described in the XM tuner's operation manual.

The following XM satellite digital tuner units cannot be connected:  
GEX P900XM, GEX P910XM

## Starting procedure

### 1 Display the AV operation screen.

- For details of the operations, refer to *Dis playing the AV operation screen* on page 74.

### 2 Tap [XM] on the left edge of the screen to display the "XM" screen.

### 3 Use the touch panel keys on the screen to control the XM tuner.

- For details, refer to *Using the touch panel keys* on page 144. 

## Reading the screen

### All CH Mode



### Category Mode



### About the logo for channel name

Only the logo data that is contained in the navigation system can be displayed for each channel. The logo of a newly established channel that is not contained cannot be displayed. When a logo is not available, the following substitute icon is displayed.

#### Substitute icon



- ❑ The icon of each broadcast station is contained in the NAND flash memory based on the data provided by XM Satellite Radio as of October 2011.
- ❑ Any changes made by XM Satellite Radio in the lineup or icon of the broadcast station in the future may not be supported by the navigation system, and may cause the unit to display incorrect icons.

### ① XM band indicator

Shows the XM band that has been selected.

### ② Current XM station information

Shows the detailed information of the broadcast channel currently being received.

- **XM channel number**

Shows the XM channel number the tuner is currently tuned to.

-  **XM station name**

Shows the XM broadcast station name the tuner is currently tuned in.

-  **Artist (performer) name**

Shows the artist (performer) name currently playing (when available).

-  **Song title (program name)**

## Using the XM tuner

Shows the title of the current song (program).

- "-----" is displayed if there is no corresponding information.

③ **Current time**

④ **XM station information**

- **XM station name logo**
- **XM channel number**
- **Preset number**

Shows what preset item has been selected.

⑤ **XM channel category**

Shows the category of broadcast channel.

⑥ **XM channel select mode indicator**

Shows what channel select mode has been selected. You can select a channel from all channels in "**All CH Mode**", and select a channel from selected category in "**Category Mode**".

⑦ **Source icon**

Shows which source has been selected.

## Using the touch panel keys

### All CH Mode

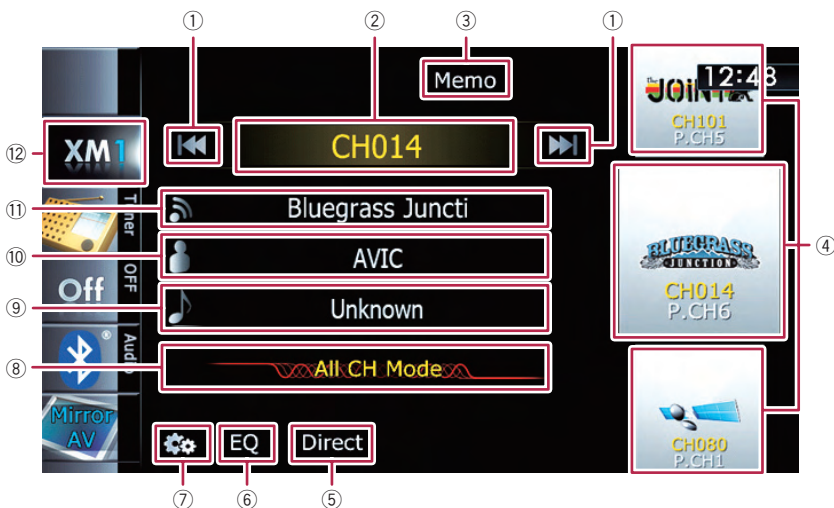

### Category Mode

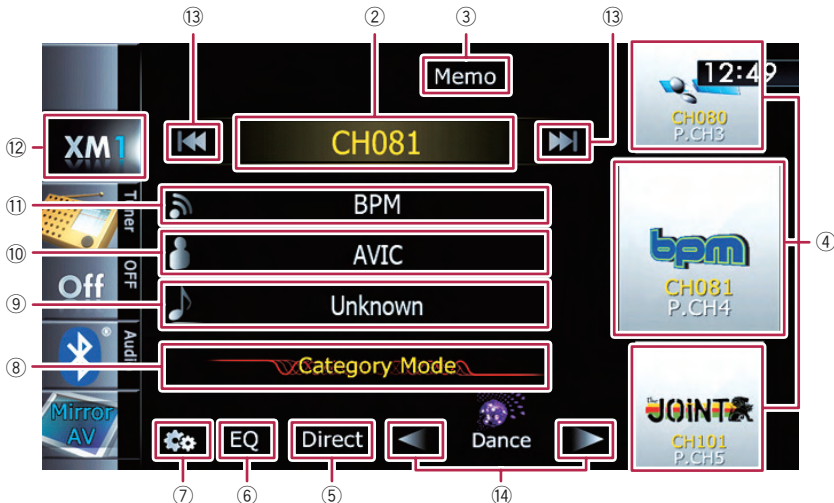

#### ① Performs manual tuning

The channels move up or down one at a time.

- If you keep touching [◀◀] or [▶▶] you can skip the broadcasting channels.

#### ② Switches between the AV operation screen and the preset list display

You can switch the screen display according to your preference.



## Using the XM tuner

- ➔ For details of the operation, refer to **Switching between the AV operation screen and the list screen** on page 74.
- ⑧ **Memorizes the current song**
  - ➔ For details, refer to *Memorizing the song* on the next page.
- ④ **Recalls channels from the preset**

Once you have stored broadcast channels, you can easily recall preset channels from memory with a tap of a key.

  - ➔ For details, refer to *Storing and recalling broadcast stations* on the next page.
- ⑤ **Selects an XM channel directly**
  - ➔ For details, refer to *Selecting an XM channel directly* on this page.
- ⑥ **Recalls equalizer curves**
  - ➔ For details, refer to *Using the equalizer* on page 182.
- ⑦ **Displays the “Function” menu**
  - ➔ For details, refer to *Using advanced functions* on page 147.
- ⑧ **Switches the XM channel select mode**

You can switch the mode between the two methods for selecting and listing the channel.

**All CH Mode:**  
You can select a channel from all channels when you operate this function.

**Category Mode:**  
You can select a channel within a selected category that you operate this function.
- ⑨ **Switches to the list display of song titles**
  - ➔ For details, refer to *Selecting a channel from the list* on the next page.
- ⑩ **Switches to the list display of artist names**
  - ➔ For details, refer to *Selecting a channel from the list* on the next page.
- ⑪ **Switches to the list display of XM station names**
  - ➔ For details, refer to *Selecting a channel from the list* on the next page.
- ⑫ **Selects an XM band**

Tapping the key repeatedly switches between the following XM bands: **XM 1**, **XM 2**, or **XM 3**.

  - This function is convenient for preparing different preset lists for each band.

### ⑬ Performs manual tuning

The channels move up or down one at a time within a selected category.

- If you keep touching [**◀◀**] or [**▶▶**] you can skip the broadcasting channels.

### ⑭ Switches the channel category

Touch [**◀**] or [**▶**] to select the desired category.

## Selecting an XM channel directly

You can select an XM channel directly by entering the desired channel number.

### 1 Touch [Direct].

### 2 Touch [0] to [9] to input the desired channel number.

To cancel the input numbers one by one, touch **⏮**. Touching and holding **⏮** allows you to delete all input numbers.

### 3 While the input number is displayed, touch [Enter].

The XM channel that was entered is selected.

### 4 Touch **⏮**.

You return to the previous display.

## Displaying the Radio ID

If you select CH: 000, the Radio ID is displayed.

### 1 Touch [Direct].

### 2 Input [000] and then touch [Enter].

- If you select another channel, display of the Radio ID is canceled.

### 3 Touch **⏮**.

You return to the previous display.

### 4 Wait until the Radio ID is displayed.

## Storing and recalling broadcast stations

With a tap of any of the preset tuning keys ("P1" to "P6"), you can easily store up to six broadcast channels for later recall (also with the tap of a key).

### 1 Select the channel that you want to store in memory.

### 2 Display the preset channel list.

- For details, refer to **Switches between the AV operation screen and the preset list display** on page 144.

### 3 Keep touching a preset tuning key [P1] to [P6].

The selected station has been stored in memory.

The next time you tap the same preset tuning key "P1" to "P6", the station is recalled from memory.

- ☐ Up to 18 stations, six for each of three XM bands can be stored in memory.

## Selecting a channel from the list

The list content can be switched so you can search for the song you want to listen to not only by the channel name but also by the artist name or song title.

- ☐ The channel list shows all channels during "All CH Mode", and the channels included in the selected category during "Category Mode".

### 1 Display a list screen.

- For details, refer to **Switches to the list display of song titles** on the previous page.
- For details, refer to **Switches to the list display of artist names** on the previous page.
- For details, refer to **Switches to the list display of XM station names** on the previous page.

### 2 Touch [List].

XM channel list appears in the display. Each touch of [List] changes the screen as follows:

**CH Name List** (Channel name)

**Song Title List** (Song title)

**Artist Name List** (Artist name)

### 3 Tap the desired channel that you want to listen to.



- For details, refer to *Operating list screens (e.g. iPod list screen)* on page 74.

- ☐ During **Category Mode**, touch [◀] or [▶] to switch to another category.

## Using "MyMix" function

"MyMix" function memorizes the song title and artist name of the song currently being received. When the song that matches the memorized song title and artist name is being broadcast on a station other than the one you are listening to, you will be alerted, and you can switch the station to listen to that song.

- ☐ A track itself is NOT downloaded. ONLY the song title and the artist name are memorized.

## Memorizing the song

The song title and artist name of the song you are listening to can be memorized to "MyMix".

### ● Touch and hold [Memo].

The song title and artist name of current song you are listening to are memorized, and a confirmation message appears.

- ☐ The song title and artist name of up to 12 songs can be memorized. Trying to save more than 12 songs will result in older ones being overwritten.
- ☐ You cannot memorize the song title or the artist name when " " is displayed on the title information.
- ☐ This function is invalid for the channel "000".

## Using the XM tuner

- ❑ The memorized title may not be displayed correctly depending on the conditions.
- ❑ You can customize the setting for the memorized songs later.
  - ➔ For details concerning operations, refer to *Setting the memorized songs* on this page.

### When the memorized song is broadcast

A beep sounds, and a message is displayed. Touch **[Yes]** to switch to that station and listen to that track.

- ❑ If the memorized song is not checked, or when **[Off]** is selected on **[Alert]** on the **"Memo Edit"** screen, no alert will be provided.
  - ➔ Refer to *Setting the memorized songs* on this page.
- ❑ Notification may not be provided depending on the status of the navigation system.
- ❑ If there is even a slight difference between the memorized title and the title of the song being broadcast, no notification will be provided even though they are the same song.

## Operating by hardware buttons

### Pressing the TRK button

You can move the channel up or down.

### Pressing and holding the TRK button

You can move channels up or down by holding down the button.

## Using advanced functions

- Touch  on the "XM" screen. The **"Function"** menu appears.

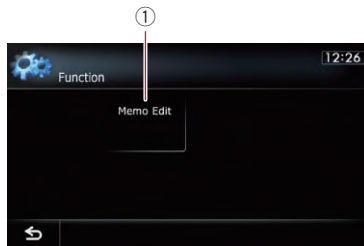

- ① Sets the memorized songs

## Setting the memorized songs

### Selecting the songs to alert

The list of song titles memorized for the MyMix Function (MyMix list) is displayed. You can change the notification setting when the song is broadcast again. You can enable or disable notification for each song.

- 1 Touch **[Memo Edit]**.
- 2 Touch the song title that you want to disable notification for.

The check mark is removed, and the notification setting of the song is deactivated.

### Changing the alert setting

You can enable or disable alerts for all items at the same time. This function is useful when you want to turn alerts off temporarily without changing each memorized song.

- 1 Touch **[Memo Edit]**.
- 2 Touch **[Alert]**.  
Each touch of **[Alert]** turns it on or off.

### Deleting the memorized songs

You can delete each one of the memorized songs from the song title list.

- 1 Touch **[Memo Edit]**.
- 2 Touch and hold the song you want to delete.
  - ❑ To delete all songs that are memorized, touch **[Delete All]**.
- 3 Touch **[Yes]**.

You can use the navigation system to control a Pioneer Sirius Satellite Radio tuner, which is sold separately.

For details concerning operation, refer to the SIRIUS tuner's operation manuals. This section provides information on SIRIUS operations with navigation system which differs from that described in the SIRIUS tuner's operation manual.

- When you use the SiriusConnect universal tuner (sold separately) with this navigation system, Pioneer SIRIUS BUS INTERFACE is required. For details concerning operation, refer to the owner's manual of Pioneer SIRIUS BUS INTERFACE and SiriusConnect universal tuner.

## Starting procedure

### 1 Display the AV operation screen.

- ⇒ For details of the operations, refer to *Displaying the AV operation screen* on page 74.

### 2 Tap [SIRIUS] on the left edge of the screen to display the "SIRIUS" screen.

### 3 Use the touch panel keys on the screen to control the SIRIUS tuner.

- ⇒ For details, refer to *Using the touch panel keys* on the next page. □

## Reading the screen

### All CH Mode

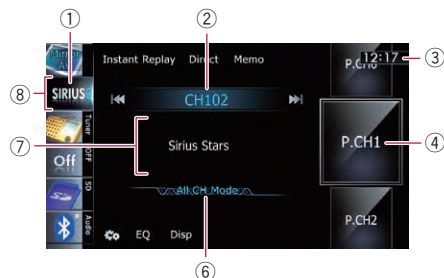

### Category Mode

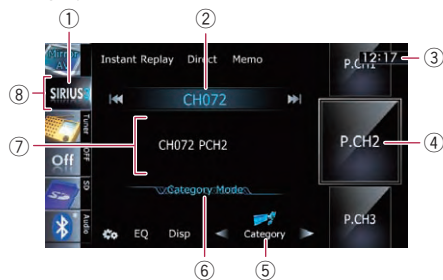

#### ① SIRIUS band indicator

Shows the SIRIUS band that has been selected.

#### ② SIRIUS channel number indicator

Shows the SIRIUS channel number that the tuner is tuned to.

#### ③ Current time

#### ④ Preset number indicator

Shows what preset item has been selected.

#### ⑤ SIRIUS channel category

Shows the category of broadcast channel.

#### ⑥ SIRIUS channel select mode indicator

Shows what channel select mode has been selected. You can select a channel from all channels in "All CH Mode", and select a channel from the selected category in "Category Mode".

- ⇒ For details concerning operations, refer to **Switches the SIRIUS channel select mode** on page 150.

#### ⑦ Variable information area

Shows various information about the broadcast channel currently being received.

- ⇒ For more details about the displayed information, refer to **Switches the SIRIUS display** on page 150.

#### ⑧ Source icon

Shows which source has been selected. □

# Using the SIRIUS tuner

## Using the touch panel keys

### All CH Mode

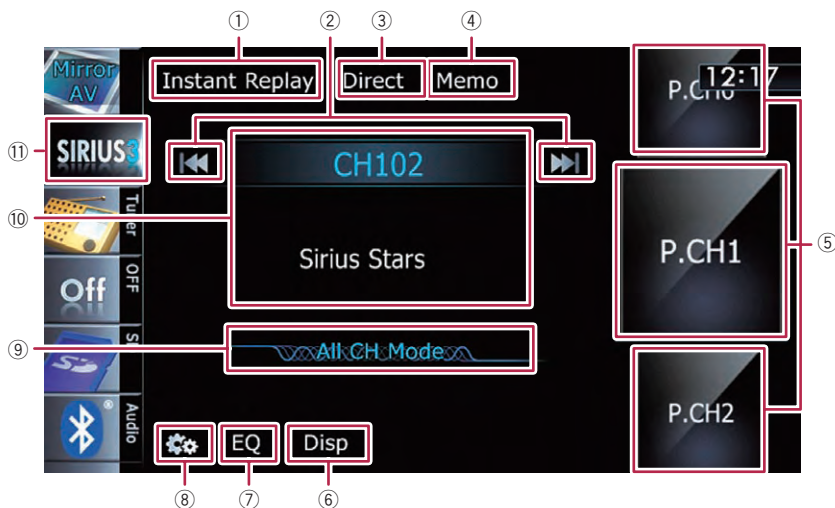

### Category Mode

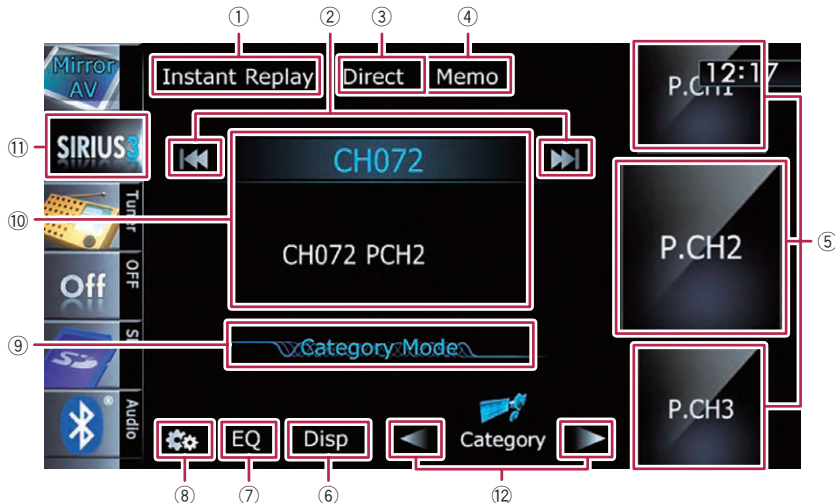

① **Switches the SIRIUS Instant replay mode**

➔ For details, refer to *Using the “Instant Replay” function* on page 151.

② **Performs manual tuning**

The channels move up or down one at a time.

☐ If you keep touching [◀◀] or [▶▶] you can skip the broadcasting channels.

③ **Selects a SIRIUS channel directly**

➔ For details, refer to *Selecting a SIRIUS channel directly* on the next page.

- ④ **Memorizes the current song**  
 ➤ For details, refer to *Memorizing the song* on the next page.
- ⑤ **Recalls channels from the preset**  
 Tap to recall the preset channel.  
 ➤ For details, refer to *Storing and recalling broadcast stations* on this page.
- ⑥ **Switches the SIRIUS display**  
 Each touch of **[Disp]** changes the display in formation.
- | Channel number | Channel name | Channel category | Artist name/feature | Song/program title | Composer |
|----------------|--------------|------------------|---------------------|--------------------|----------|
|                |              |                  |                     |                    |          |
- ⑦ **Recalls equalizer curves**  
 ➤ For details, refer to *Using the equalizer* on page 182.
- ⑧ **Displays the “Function” menu**  
 ➤ For details, refer to *Using advanced functions* on page 152.
- ⑨ **Switches the SIRIUS channel select mode**  
 You can switch the mode between the two methods for selecting and listing the channel.  
**All CH Mode:**  
 You can select a channel from all channels when you operate this function.  
**Category Mode:**  
 You can select a channel within a selected category that you operate this function.
- ⑩ **Switches between the AV operation screen and the preset list display**  
 You can switch the screen display according to your preference.  
 ➤ For details of the operation, refer to *Switching between the AV operation screen and the list screen* on page 74.
- ⑪ **Selects a SIRIUS band**  
 Tapping the key repeatedly switches between the following SIRIUS bands: **SIRIUS1**, **SIRIUS2**, or **SIRIUS3**.  
 This function is convenient for preparing different preset lists for each band.
- ⑫ **Switches the channel category**  
 Touch **[◀]** or **[▶]** to select the desired category.

## Selecting a SIRIUS channel directly

You can select a SIRIUS channel directly by entering the desired channel number.

1 **Touch [Direct].**

2 **Touch [0] to [9] to input the desired channel number.**

To cancel the input numbers one by one, touch **[C]**. Touching and holding **[C]** allows you to delete all input numbers.

3 **While the input number is displayed, touch [Enter].**

The SIRIUS channel that was entered selected.

4 **Touch [S].**

You return to the previous display.

## Display the Radio ID

If you select CH: 000, the Radio ID is displayed.

1 **Touch [Direct].**

2 **Input [000] and then touch [Enter].**

If you select another channel, display of the Radio ID is canceled.

3 **Touch [S].**

You return to the previous display.

4 **Wait until the Radio ID is displayed.**

## Storing and recalling broadcast stations

With a tap of any of the preset tuning keys (“Preset 1” to “Preset 6”), you can easily store up to six broadcast stations for later recall (also with the tap of a key).

1 **Select the channel that you want to store in memory.**

2 **Display the preset channel list.**

➤ For details, refer to *Switches between the AV operation screen and the preset list display* on this page.

## Using the SIRIUS tuner

### 3 Keep touching a preset tuning key [Preset 1] to [Preset 6].

The selected station has been stored in memory.

The next time you tap the same preset tuning key "Preset 1" to "Preset 6" the station is recalled from memory.

- ❑ Up to 18 stations, six for each of three SIRIUS bands can be stored in memory.

### Using the song alert function

The song alert function memorizes the song title and artist name of the song currently being received. When a track that matches the memorized song title and artist name is being broadcast on a station other than the one you are listening to, you will be alerted, and you can switch the station to listen to that song.

- ❑ The track itself is NOT downloaded; only the song title and the artist name are memorized.

### Memorizing the song

The song title and artist name of the song you are listening to can be memorized.

#### ● Touch and hold [Memo].

The song title and artist name of the song you are listening to can be memorized.

- ❑ Up to 10 song titles and artist names can be memorized.
- ❑ You cannot memorize a song that does not have song title and artist name information.
- ❑ You cannot memorize the song title or the artist name of channel "000".
- ❑ The memorized title may not be displayed correctly.

### When the memorized song is broadcast

A beep sounds, and a message is displayed.

Touch [Jump] to switch to that station, and you can listen to that track. If you touch [Stay], the channel does not switch.

- ❑ If the alert for the song is "Off" or set "Alert" to "Off", no notification will be provided even when that song is broadcast.

➤ For details, refer to **Setting the memorized songs** on the next page.

- ❑ Notification may not be provided depending on the situation of the Navigation System.

➤ For details, refer to *Selecting the songs to alert* on the next page.

### Using the "Instant Replay" function

The "Instant Replay" function allows you to replay the stored broadcast on Pioneer SIRIUS BUS INTERFACE (if Pioneer SIRIUS BUS INTERFACE capable for this function). As soon as you tune to a channel, Pioneer SIRIUS BUS INTERFACE automatically begins storing the broadcast. It can store approximately up to 44 minutes previous (depending on the selected channel and the memory capacity of Pioneer SIRIUS BUS INTERFACE).

#### 1 Touch [Instant Replay] on the SIRIUS screen to activate the "Instant Replay" mode.

#### 2 Touch keys for "Instant Replay".

Touch panel keys	Action
[◀◀]	Return to the start of the current song or program. Touching again will skip back to the previous song or program.
[◀◀] and hold	Fast reverses.
[▶▶]	Forwards play to the next song or program.
[▶▶] and hold	Fast forwards.
[▶/  ]	Touching [▶/  ] switches between playback and pause.

- ❑ During "Instant Replay" mode, each touch of [Disp] changes the display information as follows:  
 Time position    Channel number    Channel name    Channel category    Artist name/feature    Song/program title    Composer
- ❑ You cannot replay the broadcast prior to the beginning of stored data. ■

## Operating by hardware buttons

### Pressing the TRK button

You can move the channel up or down. During “Instant Replay” mode, you can skip the song or program forward or backward.

### Pressing and holding the TRK button

You can move channels up or down by holding down the button.

During “Instant Replay” mode, you can perform fast reverse or fast forward.

## Using advanced functions

- Touch  on the “SIRIUS” screen.

The “Function” menu appears.



- ① Sets the memorized songs
  - ② Uses the Game Alert function
  - ③ Displays Game Information
- ⇒ For details of each function, refer to sections below with the relative titles.

## Setting the memorized songs

### Selecting the songs to alert

You can change the setting of the alert when the track is broadcast again. You can enable or disable alert for each song.

- 1 Touch [Memo Edit].

- 2 Touch [◀ Prev] or [Next ▶] to select the desired song.

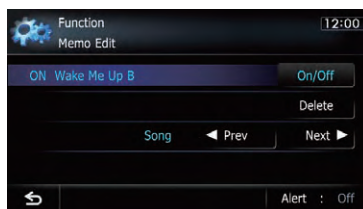

- 3 Touch [On/Off] to turn the setting on.

When the alert for the song is activated, [On] appears at the beginning of the selected title.

- Touch [On/Off] again to turn the setting off.

### Changing the alert setting

You can enable or disable alerts for all items at the same time. This function is useful when you want to turn alerts off temporarily without changing each memorized song.

- 1 Touch [Memo Edit].

- 2 Touch [Alert].

Each touch of [Alert] turns it on or off.

### Deleting the memorized songs

You can delete each one of the memorized tracks from the song title list.

- 1 Touch [Memo Edit].

- 2 Touch [◀ Prev] or [Next ▶] to select the song title that you want to delete.

- 3 Touch [Delete] when the song you want to delete is displayed.

A message will appear asking you to confirm the deletion.

- 4 Touch [Yes].

## Using the Game Alert function

### Selecting teams for Game Alert

This navigation system can alert you when games involving your favorite sports teams are about to start. To use this function you need to store the teams you want to follow in advance.



## Using the SIRIUS tuner

- 1 Touch **[Game Alert]**.
- 2 Touch **[◀ Prev]** or **[Next ▶]** to select the league.

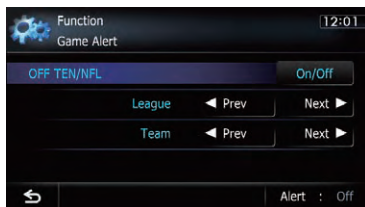

- 3 Touch **[◀ Prev]** or **[Next ▶]** to select the team.
- 4 Touch **[On/Off]**.

The team displayed as **[On]** is the alert target.

- ❑ When the selected team is excluded from the alert target, the team is displayed as **[Off]**. Up to 12 teams can be selected. If you have already selected 12 teams, **"FULL"** is displayed and adding new entries is not possible. In this case, delete a team and then try again.

### Changing the alert setting

You can enable or disable the alert for selected items. This function is useful when you want to turn the alert off temporarily without changing the setting of each selected team.

- 1 Touch **[Game Alert]**.

- 2 Touch **[Alert]**.

Each touch of **[Alert]** turns it on or off.

### When a game involving one of your favorite teams is broadcast

A message is displayed. Touch **[Jump]** to switch the station to view the game information. If you touch **[Stay]**, the station does not switch.

- ❑ Alerts may not be available depending on the status of the navigation system.

### Displaying Game Information

An alert will be displayed when a game with the team you selected is about to start (or is currently under way). You can also display game information and changes to the broadcast channel.

- ❑ The Game Information function is available when **"Alert"** is **"On"** in **"Game Alert"**.

- 1 Touch **[Game Info]**.

- 2 Touch **[Prev]** or **[Next]** to view the game score information that is registered.

- ❑ The game score will be updated automatically.
- ❑ Touch **[Tune To]** to switch to the channel that broadcasts the displayed game.
- ❑ If you have not selected any team, **"Not Set"** is displayed.
- ❑ When no games involving your favorite teams are currently being played **"NO GAME"** is displayed.

You can display the video image output by the equipment connected to the navigation system. For details of the connection method, refer to Installation Manual.

### **!** CAUTION

For safety reasons, video images cannot be viewed while your vehicle is in motion. To view video images, you must stop in a safe place and apply the parking brake.

## Reading the screen



① Current time

② Source icon

Shows which source has been selected.

## Using AV1

You can display the video image output by the equipment connected to video input 1.

**1 Touch [AV1 Input] on the “AV System Settings” menu.**

➔ For details, refer to *Setting video input 1 (AV1)* on page 177.

**2 Display the AV operation screen.**

➔ For details of the operations, refer to *Displaying the AV operation screen* on page 74.

**3 Tap [AV1] on the left edge of the screen.**

The image is displayed on the screen.

**4 Touch the screen to display the touch panel keys.**

## Using AV2

You can display the video image output by the equipment connected to video input 2.

**1 Touch [AV2 Input] on the “AV System Settings” menu.**

➔ For details, refer to *Setting video input 2 (AV2)* on page 178.

**2 Display the AV operation screen.**

➔ For details of the operations, refer to *Displaying the AV operation screen* on page 74.

**3 Tap [AV2] on the left edge of the screen.**

The image is displayed on the screen.

**4 Touch the screen to display the touch panel keys.**

## Using the touch panel keys

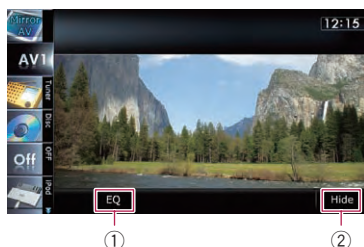

① Recalls equalizer curves

➔ For details, refer to *Using the equalizer* on page 182.

② Hides the touch panel keys

Touching [Hide] hides the touch panel keys.

If you want to display the touch panel keys again, touch anywhere on the LCD screen.

## Using the external unit (EXT1, EXT2)

The term “external unit” refers to future Pioneer devices that are not currently planned for, or to devices that allow control of basic functions although they are not fully controlled by the navigation system. Two external units can be controlled by this navigation system. When two external units are connected, the navigation system allocates them as external unit 1 or external unit 2.

For details of the connection method, refer to Installation Manual.

For details of the operation, refer to the external unit's operation manual. This section provides information on external unit operations with the navigation system that differ from those described in the external unit's operation manual.

- ❑ Operation varies depending on the external unit connected. (In some cases, the external unit may not respond.)

### Starting procedure

#### 1 Display the AV operation screen.

- ➔ For details of the operations, refer to *Displaying the AV operation screen* on page 74.

#### 2 Tap [EXT1] or [EXT2] on the left edge of the screen to select the external unit.

#### 3 Use the touch panel keys on the screen to control the external unit.

- ➔ For details, refer to *Using the touch panel keys* on the next page. ■

### Reading the screen



#### ① Source icon

Shows which source has been selected.

#### ② External unit indicator

Displays the information that is sent by connected external units.

#### ③ Current time

#### ④ Auto/Manual mode indicator

Shows the current mode. ■

## Using the touch panel keys

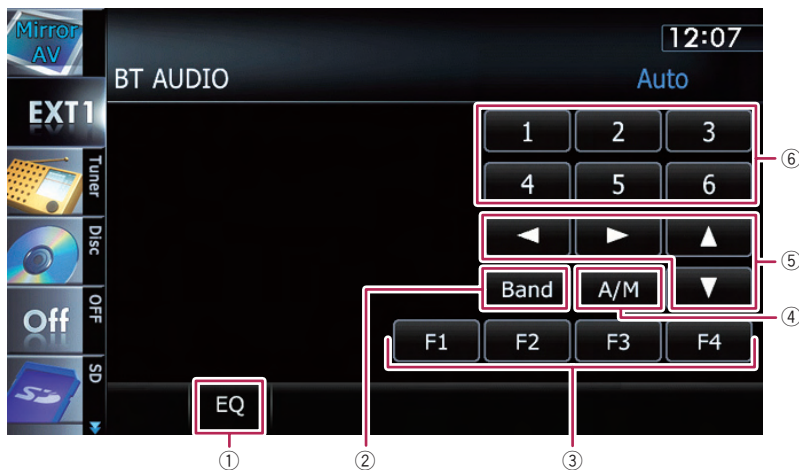

- ① **Recalls equalizer curves**
  - For details, refer to *Using the equalizer* on page 182.
- ② **Sends a band command**

Touch to send a band command to the external unit.

  - ❑ Operation varies depending on the external unit connected. (In some cases, the external unit may not respond.)
- ③ **Uses [F1] through [F4] to operate the external unit**

The external unit can be operated by transmitting the operating commands set to "F1" through "F4".

  - ❑ The operating commands set to "F1" through "F4" vary depending on the external unit.
  - ❑ Some functions may not be used until you touch and hold the key.
- ④ **Switches between automatic and manual function**

You can turn automatic and manual function on or off.

You can switch between "Auto" and "Manual" functions of the external unit connected.

Initially, this function is set to "Auto".

  - ❑ Operating commands set for "Auto" and "Manual" operations vary depending on the external unit connected.
- ⑤ **Sends a command [▲], [▼], [◀], or [▶]**

Touch to operate the external unit.

  - ❑ Operation varies depending on the external unit connected. (In some cases, some functions may not be used until you touch and hold the key.)
- ⑥ **Sends a [1] key to [6] key command**

The external unit can be operated by transmitting the operating commands set to "1" key through "6" key.

  - ❑ Operation varies depending on the external unit connected. (In some cases, some functions may not be used until you touch and hold the key.)

## Customizing preferences

### Displaying the screen for navigation settings

1 Press the HOME button to display the “Top Menu” screen.

2 Touch [Settings].

The “Settings Menu” screen appears.

- This can also be operated using the “Short cut Menu” screen.

3 Touch [Navi Settings].

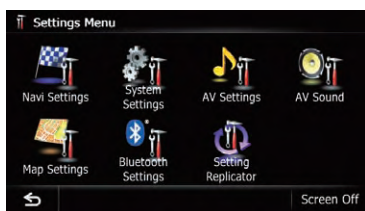

The “Navi Settings” menu appears.

4 Touch the item that you want to change the setting.

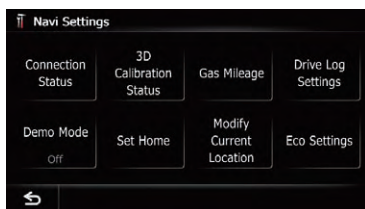

- If you touch , the previous screen returns.

### Checking the connections of leads

Check that leads are properly connected between the navigation system and the vehicle. Please also check whether they are connected in the correct positions.

1 Display the “Navi Settings” screen.

- ➔ For details, refer to *Displaying the screen for navigation settings* on this page.

2 Touch [Connection Status].

The “Connection Status” screen appears.

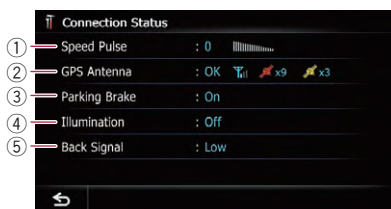

① Speed Pulse

The Speed Pulse value detected by the navigation system is shown. “0” is shown while the vehicle is stationary.

② GPS Antenna

Indicates the connection status of the GPS antenna, the reception sensitivity, and from how many satellites the signal is received.

Color	Signal communication	Used in positioning
Orange	Yes	Yes
Yellow	Yes	No

- When the GPS antenna is connected to this navigation system, “OK” is displayed. When the GPS antenna is not connected to this navigation system, “NOK” is displayed.
- If reception is poor, please change the installation position of the GPS antenna.

③ Parking Brake

When the parking brake is applied, “On” is displayed. When the parking brake is released, “Off” is displayed.

④ Illumination

When the headlights or small lamps of a vehicle are on, “On” is displayed. When the small lamps of a vehicle are off, “Off” is displayed. (If the orange/white lead is not connected, “Off” appears.)

⑤ Back Signal

When the shift lever is shifted to “**R**”, the signal switches to “**High**” or “**Low**”. (One of these is displayed depending on the vehicle.) 

## Checking sensor learning status and driving status

- The navigation system can automatically use its sensor memory based on the outer dimensions of the tires.

### 1 Display the “Navi Settings” screen.

- ➔ For details, refer to *Displaying the screen for navigation settings* on the previous page.

### 2 Touch [3D Calibration Status].

The “**3D Calibration Status**” screen appears.

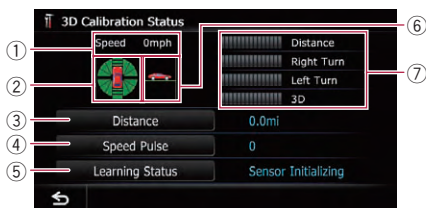

#### ① Speed

Indicates the speed detected by the navigation system. (This indication may be different from the actual speed of your vehicle, so please do not use this instead of the speedometer.)

#### ② Acceleration or deceleration/Rotational speed

Indicates acceleration or deceleration velocity of your vehicle. Also, rotational speed when your vehicle turns to left or right is shown.

#### ③ Distance

Indicates driving distance.

#### ④ Speed Pulse

Indicates the total number of speed pulses.

#### ⑤ Learning Status

Indicates the current driving mode.

#### ⑥ Inclination

Indicates the degree of slope of the street that you are currently on.

#### ⑦ Degree of learning

Sensor learning situations for distance (**Distance**), right turn (**Right Turn**), left turn (**Left Turn**) and 3D detection (**3D**) are indicated by the length of bars.

- When tires have been changed or chains fitted, turning on the Speed Pulse allows the system to detect the fact that the tire diameter has changed, and automatically replaces the value for calculating distance.
- If a separately sold speed pulse generator (ND PG1) is connected, the distance calculation value cannot be replaced automatically.

## Clearing status

You can delete the learned results stored in “**Distance**”, “**Speed Pulse**” or “**Learning Status**”.

### 1 Touch [Distance] or [Speed Pulse].

The following message appears.



### 2 Touch [Yes].

Clears the results stored in “**Distance**” or “**Speed Pulse**”.

### 3 Touch [Learning Status].

The following message appears.

## Customizing preferences



### 4 Touch [All].

Clears all leaning results.

- Touch **[All]** for the following cases:
  - After changing the installation position of the navigation system
  - After changing the installation angle of the navigation system
  - After moving the navigation system to another vehicle
- If you touch **[Distance]**, all learned results stored in "**Distance**" are cleared.

## Using the fuel consumption function

### Inputting the fuel consumption information for calculating the fuel cost

You can estimate the fuel cost to your destination by entering the fuel consumption information in the navigation system.

➔ For details, refer to *Setting a route to your destination* on page 45.

#### 1 Display the "Navi Settings" screen.

- ➔ For details, refer to *Displaying the screen for navigation settings* on page 157.

#### 2 Touch [Gas Mileage].

The "**Gas Mileage Setting**" screen appears.

### 3 Enter the fuel consumption information.



Enter the following items:

- **Surface Road Gas Mileage:**  
Enter the fuel cost when you drive on ordinary roads.
- **Freeway Gas Mileage:**  
Enter the fuel cost when you drive on the freeway.
- **Gas Price Per Unit:**  
Enter the fuel unit price.
- **Gas Unit:**  
Set the fuel unit.
- **Currency:**  
Set the unit of currency.
- The unit in "**Surface Road Gas Mileage**" and "**Freeway Gas Mileage**" depend on the one chosen in "**Gas Unit**".
  - When "**Gas Unit**" is set to "**Gallon**".  
Enter how many miles (kilometers) you get to a gallon.
  - When "**Gas Unit**" is set to "**Liter**".  
Enter how much fuel you need to travel 60 miles (100 kilometers).

When all the items are entered, inputting the fuel consumption information is complete.

### Calculating the fuel consumption

When you enter the fueling information to the navigation system, and export the data to SD memory cards, you can check the fuel consumption information by using the utility program AVIC FEEDS, which is available separately, on your PC.

- Up to 24 sets of data can be stored. You can also export the data, as described below.

If the entries reach the maximum number, a new entry will overwrite the oldest one.

These calculations are based only on the information that you provide and not on any data from the vehicle. The fuel mileage displayed is only a reference value, and does not guarantee the fuel mileage displayed can be obtained.

### 1 Display the “Navi Settings” screen.

- ➔ For details, refer to *Displaying the screen for navigation settings* on page 157.

### 2 Touch [Gas Mileage].

The “Gas Mileage Setting” screen appears.

### 3 Touch [Gas Price Calculation].

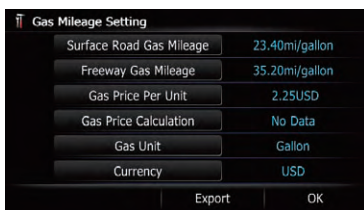

The “Gas Price Calculation” screen appears.

### 4 Enter the fuel consumption information.

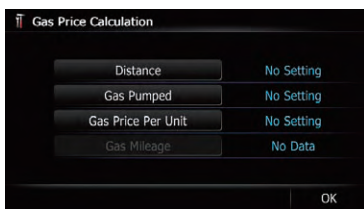

Enter the following items:

- **Distance:**  
Enter the distance traveled since the previous fueling.
  - The distance is entered automatically only when the distance traveled since the previous fueling is recorded.
- **Gas Pumped:**  
Enter the amount of fuel pumped.

- **Gas Price Per Unit:**

Enter the fuel unit price.

When all the items are entered, the fuel consumption is displayed next to “Gas Mileage”.

### 5 Touch [OK].

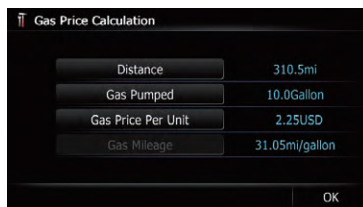

The “Gas Mileage Setting” screen appears.

## Exporting the data of fuel cost information

Exporting the fuel cost data to an SD memory card is possible.

- The data stored in this navigation system will be cleared as exporting it to the SD memory card.
- If there is previous data in the SD memory card, the data is overwritten with new data.

### 1 Insert an SD memory card into the SD card slot.

- ➔ For details of the operation, refer to *Inserting and ejecting an SD memory card* on page 18.

### 2 Display the “Navi Settings” screen.

- ➔ For details, refer to *Displaying the screen for navigation settings* on page 157.

### 3 Touch [Gas Mileage].

The “Gas Mileage Setting” screen appears.



## Customizing preferences

### 4 Touch [Export].

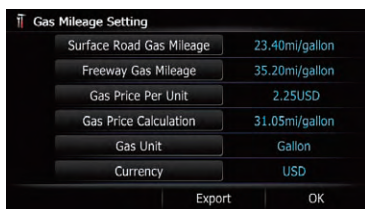

After a message confirming whether to export the data appeared, exporting the data to the SD memory card starts.

The “**Gas Mileage Setting**” screen appears when it is done.

## Recording your travel history

Activating the track logger enables you to record your driving history (called “track log” below). You can review the travel history later.

- If an SD memory card is inserted into the SD card slot, the track logs will be stored in the SD memory card.

### 1 Insert an SD memory card into the SD card slot.

- For details of the operation, refer to *Inserting and ejecting an SD memory card* on page 18.

### 2 Display the “Navi Settings” screen.

- For details, refer to *Displaying the screen for navigation settings* on page 157.

### 3 Touch [Drive Log Settings].

The “**Drive Log Settings**” screen appears.

### 4 Touch [Drive Log Settings].

Each time you touch the key changes the setting.

- **Off** (default):  
You cannot export your track log to the SD memory card.
- **On**:  
You can store your track log to the SD memory card.

- While the setting is “**On**”, the navigation system continues to store the track logs in the inserted SD memory card.

### 5 Touch [Type].

Each time you touch the key changes the setting.

- **Private** (default):  
Changes the track log attribute to “**Private**”.
- **Business**:  
Changes the track log attribute to “**Business**”.
- **Other**:  
Changes the track log attribute to “**Other**”.

## Using the demonstration guidance

This is a demonstration function for retail stores. After a route is set, touching this key starts the simulation of route guidance.

### 1 Display the “Navi Settings” screen.

- For details, refer to *Displaying the screen for navigation settings* on page 157.

### 2 Touch [Demo Mode].

Each time you touch the key changes the setting.

- **Off** (default):  
The demonstration guidance is set off.
- **On**:  
Repeats the demonstration guidance.

### 3 Display the map screen.

The demonstration guidance will begin.

- For details of the operations, refer to *Screen switching overview* on page 26.

## Registering your home

Registering your home position saves time and effort. Also, routes to home positions can be calculated easily with a single touch of the key from the “**Destination Menu**”. The registered home position can also be modified later.

### 1 Display the “Navi Settings” screen.

- For details, refer to *Displaying the screen for navigation settings* on page 157.

### 2 Touch [Set Home].

The “**Set Home**” screen appears.

### 3 Touch [Home].

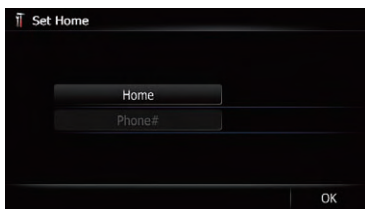

The “**Select Search method**” screen appears.

- If you touch [Phone#], you can edit your home phone number.
  - ☐ [Phone#] is only available when you have already registered your home phone number.

### 4 Search for a location.

- For details, refer to Chapter 6.

After searching for a point, the map of the selected position is displayed.

### 5 Touch [OK].

The location is registered, and then the “**Set Home**” screen appears.

### 6 Touch [OK].

The registration is complete. ☐

## Correcting the current location

Touch the screen to adjust the current position and direction of the vehicle displayed on the map.

### 1 Display the “Navi Settings” screen.

- For details, refer to *Displaying the screen for navigation settings* on page 157.

### 2 Touch [Modify Current Location].

### 3 Scroll to the position where you want to set, then touch [OK].

### 4 Touch the arrow key on the screen to set the direction, then touch [OK]. ☐

## Changing the eco-function setting

You can change the eco function setting.

### 1 Display the “Navi Settings” screen.

- For details, refer to *Displaying the screen for navigation settings* on page 157.

### 2 Touch [Eco Settings].

The “**Eco Settings**” screen appears.

### 3 Touch each item.



On this screen, you can operate the following items.

- **Eco Score**
  - **On** (default): Displays “**Eco Score**”.
  - **Off**: Hides “**Eco Score**”.

## Customizing preferences

➤ For details, refer to *Checking the eco friendly driving status* on page 35.

### • Eco Drive Level

#### • On (default):

After you arrive the destination, a message appears and a beep sounds if the level of “**Eco Drive Level**” have increased or decreased.

#### • Off:

No message appears and no sound beeps when the vehicle reaches the destination.

➤ For details, refer to *Displaying Eco Drive Level guidance* on page 36.

### • Rapid Start Warning

#### • Off (default):

No message appears and no sound beeps when the vehicle experiences a sudden start.

#### • On:

A message appears and a sound beeps when the vehicle experiences a sudden start.

➤ For details, refer to *Sudden start alert* on page 36.

### 4 Touch [OK].

The settings are complete.

## Clearing the fuel consumption information

You can clear the fuel consumption information accumulated to date.

### 1 Display the “Navi Settings” screen.

➤ For details, refer to *Displaying the screen for navigation settings* on page 157.

### 2 Touch [Eco Settings].

The “**Eco Settings**” screen appears.

### 3 Touch [Clear Eco Record].

The message confirming whether to clear the fuel consumption information appears.

### 4 Touch [Yes].

Fuel consumption data are cleared.

## Displaying the screen for map settings

1 Press the HOME button to display the “Top Menu” screen.

2 Touch [Settings].

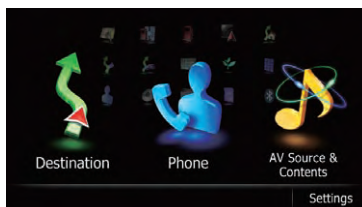

The “**Settings Menu**” screen appears.

3 Touch [Map Settings].

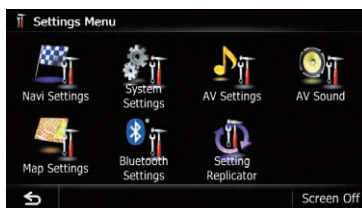

The “**Map Settings**” screen appears.

4 Touch the item that you want to change the setting.

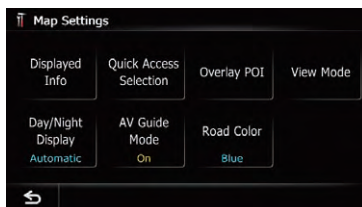

▪ If you touch , the previous screen returns.

## Setting the auto-zoom display

This setting enables switching to an enlarged map around the point where your vehicle is approaching an intersection, entrance/exit of freeway or a junction.

### 1 Display the “Map Settings” screen.

- ➔ For details, refer to *Displaying the screen for map settings* on the previous page.

### 2 Touch [Displayed Info].

The “Displayed Information” screen appears.

### 3 Touch [Close Up View].

Each time you touch the key changes the setting.

- **On** (default):  
Switches to an enlarged map.
- **Off**:  
Does not switch to an enlarged map.

## Setting the detailed city map

- The detailed city map and this setting are available for AVIC Z140BH only.

You can select whether to display the city map when in certain metropolitan city areas.

- The city map is displayed when the map scale is 0.05 mile (50 meters) or less.

### 1 Display the “Map Settings” screen.

- ➔ For details, refer to *Displaying the screen for map settings* on the previous page.

### 2 Touch [Displayed Info].

The “Displayed Information” screen appears.

### 3 Touch [City Map].

Each time you touch the key changes the setting.

- **On** (default):  
Automatically switches to the city map when in a city map area.
- **Off**:  
Does not show the city map.

- Even if you switch “City Map” to “On”, city map cannot be displayed in areas where there is no city map data.

## Setting the barrier graphic for city map

- The detailed city map and this setting are available for AVIC Z140BH only.

On the city map screen, you can display a “barrier graphic” pattern where no city map data is available. This prevents a normal map of a different scale from being displayed at the same time, greatly enhancing the clarity of the city map on screen.

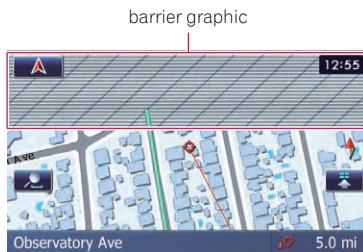

### 1 Display the “Map Settings” screen.

- ➔ For details, refer to *Displaying the screen for map settings* on the previous page.

### 2 Touch [Displayed Info].

The “Displayed Information” screen appears.

### 3 Touch [City Map Barrier].

Each time you touch the key changes the setting.

- **On** (default):  
Displays the barrier graphic for city map. When the vehicle position or cursor enters the barrier graphic area, the graphic disappears and a normal map is displayed full screen.
- **Off**:

## Customizing preferences

Does not display the barrier graphic for city map. When the vehicle position or cursor enters the area where no city map data is available, a normal map is displayed full screen.

### Displaying the traffic notification icon

Selects whether to display or hide the traffic notification icons on the map when incidents occur on your route.

➔ For details, refer to *Checking traffic information manually* on page 57.

#### 1 Display the “Map Settings” screen.

➔ For details, refer to *Displaying the screen for map settings* on page 163.

#### 2 Touch [Displayed Info].

The “**Displayed Information**” screen appears.

#### 3 Touch [Show Traffic Incident].

Each time you touch the key changes the setting.

- **View** (default):  
Displays the icons on the map.
- **Hide:**  
Hides the icons on the map.

### Displaying the Bluetooth connection icon

Selects whether to display or hide the icon for current status of the phone connection via Bluetooth wireless technology.

Bluetooth connection icon

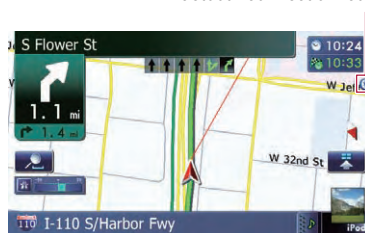

#### 1 Display the “Map Settings” screen.

➔ For details, refer to *Displaying the screen for map settings* on page 163.

#### 2 Touch [Displayed Info].

The “**Displayed Information**” screen appears.

#### 3 Touch [Bluetooth Connected].

Each time you touch the key changes the setting.

- **View** (default):  
Displays the Bluetooth connection icon on the map.
- **Hide:**  
Hides the Bluetooth connection icon on the map.

### Setting the current street name display

Selects whether to display or hide the street name (or city name) that your vehicle is traveling along.

#### 1 Display the “Map Settings” screen.

➔ For details, refer to *Displaying the screen for map settings* on page 163.

#### 2 Touch [Displayed Info].

The “**Displayed Information**” screen appears.

### 3 Touch [Current Street Name].

Each time you touch the key changes the setting.

- **View** (default):  
Displays the street name (or city name) on the map.
- **Hide:**  
Hides the street name (or city name) on the map.

## Setting the display of icons of favorite locations

You can select whether to display the “Favorites” icon on the map.

- “Favorites” icons are displayed when the map scale is 10 miles (20 kilometers) or less.
- ➔ For details, refer to *Editing the favorite location in the list* on page 50.

### 1 Display the “Map Settings” screen.

- ➔ For details, refer to *Displaying the screen for map settings* on page 163.

### 2 Touch [Displayed Info].

The “Displayed Information” screen appears.

### 3 Touch [Favorites Icon].

Each time you touch the key changes the setting.

- **On** (default):  
Displays the “Favorites” icon on the map.
- **Off:**  
Hides the “Favorites” icon on the map.

## Displaying the 3D landmarks

- The 3D landmarks and this setting are available for AVIC Z140BH only.

You can select whether to display the 3D landmark on the map.

- 3D landmark only appears when the view mode is “3D View” and the map scale is set to 0.25 mile (200 m) or lower.

### 1 Display the “Map Settings” screen.

- ➔ For details, refer to *Displaying the screen for map settings* on page 163.

### 2 Touch [Displayed Info].

The “Displayed Information” screen appears.

### 3 Touch [3D Land Mark].

Each time you touch the key changes the setting.

- **On** (default):  
Displays the 3D landmark on the map.
- **Off:**  
Hides the 3D landmark on the map.

## Displaying maneuvers

Selects whether to display or hide maneuvers on the map.

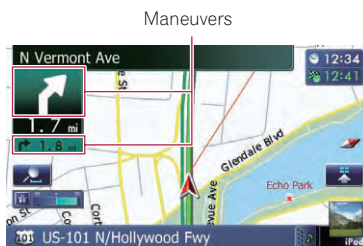

### 1 Display the “Map Settings” screen.

- ➔ For details, refer to *Displaying the screen for map settings* on page 163.

### 2 Touch [Displayed Info].

The “Displayed Information” screen appears.

### 3 Touch [Show Maneuver].

Each time you touch the key changes the setting.

- **View** (default):  
Displays maneuvers on the map.
- **Hide:**  
Hides maneuvers on the map.

## Customizing preferences

### Displaying the fuel consumption information

Selects whether to display Eco Meter, indicating the fuel consumption information, on the map.

- Eco Meter appears when “2D View” or “3D View” is selected.

#### 1 Display the “Map Settings” screen.

- ➔ For details, refer to *Displaying the screen for map settings* on page 163.

#### 2 Touch [Displayed Info].

The “Displayed Information” screen appears.

#### 3 Touch [Show Eco Meter].

Each time you touch the key changes the setting.

- **View** (default):  
Displays Eco Meter on the map.
- **Hide:**  
Hides Eco Meter on the map.

### Displaying POI on the map

Displays icons for the surrounding facilities (POI) on the map.

- POI icons are not displayed when the map scale is 0.75 mile (1 kilometer) or more.
- Up to 200 items, 100 preinstalled POIs or 100 custom POIs, are displayed on the map.

### Displaying preinstalled POIs on the map

- You can select up to 10 items from the subcategories or detailed categories.

#### 1 Display the “Map Settings” screen.

- ➔ For details, refer to *Displaying the screen for map settings* on page 163.

#### 2 Touch [Overlay POI].

The “Overlay POI” screen appears.

#### 3 Touch [Display] to change the setting to “On”.

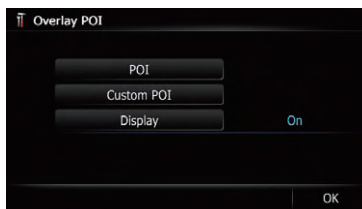

- If you do not want to display the POI icon on the map, touch [Display] to turn it “Off”. (Even if “Display” is turned “Off”, the POI selection setting is retained.)

#### 4 Touch [POI].

The “Overlay POI (Main Category)” screen appears.

#### 5 Touch the main category you want.

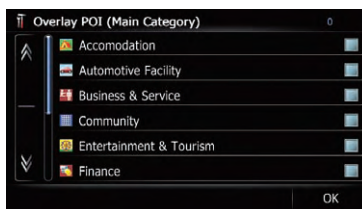

A list of subcategories under the selected main category appears.

- Categories that are already selected will have a blue check mark.

#### 6 Touch the subcategory to display.

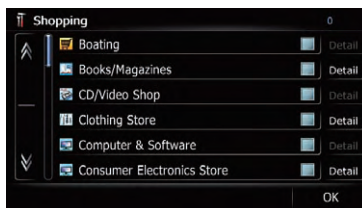

A red check mark appears next to the selected category. To cancel the selection, touch the entry again.

If there are detailed categories within the sub category, **[Detail]** is active. If you select the subcategory such, all detailed categories with in the subcategory is selected and **[Detail]** be comes inactive.

- If you touch **[Detail]**, the detailed categories under the subcategory are displayed. Select a detailed category of your preference and touch **[OK]**.

- When only a few detailed categories are selected, a blue check mark will appear next to the selected subcategory.

### 7 Touch **[OK]**.

The **“Overlay POI (Main Category)”** screen returns.

If you want to select or deselect other items, repeat these steps as many as necessary.

### 8 To finish the selection, touch **[OK]** in the **“Overlay POI (Main Category)”** screen.

## Displaying the customized POIs

Creating a customized POI is possible by using the utility program AVIC FEEDS which is available separately, on your PC. (AVIC FEEDS will be available on our website.) Storing the customized POI properly and inserting the SD memory card enables the system to display the icons on the map screen.

- You can select up to 10 items from the sub categories or detailed categories.

### 1 Insert an SD memory card into the SD card slot.

- ➔ For details of the operation, refer to *Inserting and ejecting an SD memory card* on page 18.

### 2 Display the **“Map Settings”** screen.

- ➔ For details, refer to *Displaying the screen for map settings* on page 163.

### 3 Touch **[Overlay POI]**.

The **“Overlay POI”** screen appears.

### 4 Touch **[Display]** to change the setting to **“On”**.

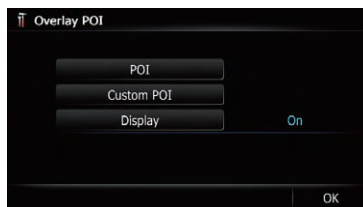

- If you do not want to display the POI icon on the map, touch **[Display]** to turn it **“Off”**. (Even if **“Display”** is turned **“Off”**, the POI selection setting is retained.)

### 5 Touch **[Custom POI]**.

The list of POI categories appears.

### 6 Touch the items you want to display.



### 7 To finish the selection, touch **[OK]**.

## Changing the view mode

Various types of screen displays can be selected for navigation guidance.

- ➔ For details of the operation, refer to *Switching the view mode* on page 34. □

## Setting the map color change between day and night

To improve the visibility of the map during the evening, you can set the timing for changing the combination of the map color.



## Customizing preferences

### 1 Display the “Map Settings” screen.

- ➔ For details, refer to *Displaying the screen for map settings* on page 163.

### 2 Touch [Day/Night Display].

Each time you touch the key changes the setting.

- **Automatic** (default):  
You can change the colors of a map between daytime and nighttime according to whether the vehicle lights are on or off.
- **Day:**  
The map is always displayed with daytime colors.
- To use this function with “Automatic”, the orange/white lead of the navigation system must be connected correctly.

## Changing the road color

You can set the road color to bluish or reddish.

### 1 Display the “Map Settings” screen.

- ➔ For details, refer to *Displaying the screen for map settings* on page 163.

### 2 Touch [Road Color].

Each time you touch the key changes the setting.

- **Blue** (default):  
Changes to blue based road colors.
- **Red:**  
Changes to red based road colors.

## Changing the setting of navigation interruption screen

You can set whether to automatically switch to the navigation screen from the AV screen when your vehicle approaches a guidance point such as an intersection.

### 1 Display the “Map Settings” screen.

- ➔ For details, refer to *Displaying the screen for map settings* on page 163.

### 2 Touch [AV Guide Mode].

Each time you touch the key changes the setting.

- **On** (default):  
Switches from the AV operation screen to the map screen.
- **Off:**  
Does not switch the screen.
- This setting is effective only when “Close Up View” is set to “On”.

## Selecting the “Quick Access” menu

Select items to display on the map screen. In the list displayed on screen, the items with red checks are displayed on the map screen. Touch the item you want to display and then touch [OK] when a red check appears. You can select up to five items.

### 1 Display the “Map Settings” screen.



- ➔ For details, refer to *Displaying the screen for map settings* on page 163.









### 2 Touch [Quick Access Selection].

The “Quick Access Selection” screen appears.

### 3 Touch the item that you want to set in “Quick Access”.

You can select the following items:

- Settings marked with an asterisk (\*) show that these are default or factory settings.
-  **Registration\***  
Register information on the location indicated by the cursor to “Favorites”.  
➔ For details, refer to *Registering a location by scroll mode* on page 50.
-  **Vicinity Search\***  
Find POIs (Points Of Interest) in the vicinity of the cursor.  
➔ For details, refer to *Searching for a nearby POI* on page 41.
-  **Overlay POI\***  
Displays icons for surrounding facilities (POI) on the map.

- For details, refer to *Displaying POI on the map* on page 167.
-  : **Volume\***  
Displays the "**Volume Settings**" screen.
  - For details, refer to *Setting the Volume for Guidance and Phone* on page 172.
-  : **Contacts\***  
Displays the "**Contacts List**" screen.
  - For details, refer to *Calling a number in the phone book* on page 65.
-  : **Whole Route Overview**  
Displays the entire route (currently set) with the "**Route Overview**" screen.
  - For details, refer to *Displaying the route overview* on page 46.
-  : **Traffic on Route**  
Displays a list of traffic information on the route.
  - For details, refer to *Checking traffic information on the route* on page 55.
-  : **Traffic Events**  
Displays a list of traffic events information.
  - For details, refer to *Checking all traffic information* on page 54.
-  : **Day/Night Display**  
Switches **Day/Night Display** setting.
  - For details, refer to *Setting the map color change between day and night* on page 168.
-  : **Favorites Icon**  
Switches **Favorites Icon** setting.
  - For details, refer to *Setting the display of icons of favorite locations* on page 166.
-  : **Position Fix**  
When the vehicle position enters a different street parallel to the street you are traveling, the vehicle position returns to the street you are traveling.

#### 4 To finish the setting, touch [OK].

## Displaying the screen for system settings

- 1 Press the HOME button to display the "Top Menu" screen.

### 2 Touch [Settings].

The "**Settings Menu**" screen appears.

- This can also be operated using the "Short cut Menu" screen.

### 3 Touch [System Settings].

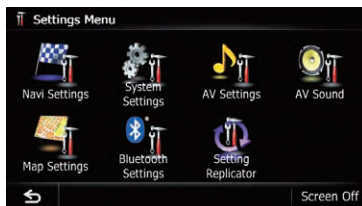

The "**System Settings**" screen appears.

### 4 Touch the item that you want to change the setting.

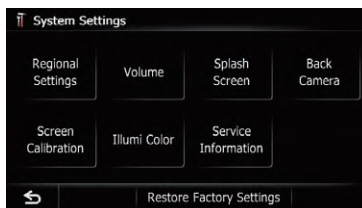

- If you touch , the previous screen returns.

## Customizing the regional settings

### 1 Display the "System Settings" screen.

- For details, refer to *Displaying the screen for system settings* on this page.

### 2 Touch [Regional Settings].

The "**Regional Settings**" screen appears.



## Customizing preferences

### Selecting the language

You can set the languages used on the program and voice guidance. Each language can be set separately.

#### 1 Display the “System Settings” screen.

- For details, refer to *Displaying the screen for system settings* on the previous page.

#### 2 Touch [Regional Settings].

The “Regional Settings” screen appears.

#### 3 Touch [Program Language].

The “Select Program Language” screen appears.

#### 4 Touch the desired language.

After the language is selected, the previous screen returns.

#### 5 Touch [Voice Language].

The “Voice Language Selection” screen appears.

#### 6 Touch the desired language.

After the language is selected, the previous screen returns.

#### 7 Touch [OK] on the “Regional Settings” screen.

A message confirming whether to restart the navigation system appears.

#### 8 Touch [OK].

The navigation system restarts.

### Setting the time difference

Adjusts the system’s clock. Set the time difference (+, –) from the time originally set in your navigation system.

#### 1 Display the “System Settings” screen.

- For details, refer to *Displaying the screen for system settings* on the previous page.

#### 2 Touch [Regional Settings].

The “Regional Settings” screen appears.

#### 3 Touch [Time].

The “Time Settings” screen appears.

#### 4 To set the time difference, touch [+] or [-].

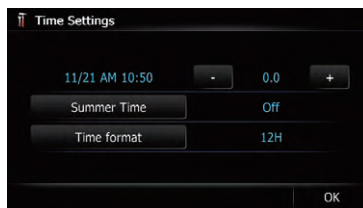

The time difference between the time originally set in the navigation system (Pacific Standard Time) and the current location of your vehicle is shown. If necessary, adjust the time difference. Touching [+] or [-] changes the time difference display in half hour increments.

The time difference can be set from “–4” to “+9” hours.

#### 5 Touch [Summer Time].

Summer time setting is off by default. Touch [Summer Time] to change the setting if you are in the summer time period.

#### 6 Touch [Time format].

Each time you touch the key changes the setting.

- **12H** (default):  
Changes the display to 12 hour format with am/pm.
- **24H**:  
Changes the display to 24 hour format.

### Changing the unit between km and miles

This setting controls the unit of distance and speed displayed on your navigation system.

#### 1 Display the “System Settings” screen.

- For details, refer to *Displaying the screen for system settings* on the previous page.

#### 2 Touch [Regional Settings].

The “Regional Settings” screen appears.

### 3 Touch [km / mile].

A message confirming whether to change the setting appears.

### 4 Touch [Yes].

Each time you touch the key changes the setting.

- **mile** (default):  
Shows distance in miles.
  - **Mile&Yard**:  
Shows distance in miles and yards.
  - **km**:  
Shows distance in kilometers.
- If you touch [No], the setting is canceled.

## Changing the virtual speed of the vehicle

When calculating the expected time of arrival and the travel time to the destination, set the average speed for the freeway or ordinary roads using [+] and [-].

### 1 Display the “System Settings” screen.

- ➔ For details, refer to *Displaying the screen for system settings* on page 170.

### 2 Touch [Regional Settings].

The “Regional Settings” screen appears.

### 3 Touch [Average Speed].

The “Average Speed Settings” screen appears.

### 4 Touch [+] or [-] to set the speed.



- The estimated time of arrival may not be taken into account other parameters than this speed value.

### 5 Touch [OK].

The settings are complete.

## Setting the Volume for Guidance and Phone

The sound volume for the navigation can be set. You can separately set the volume of the route guidance and the beep sound.

### 1 Display the “System Settings” screen.

- ➔ For details, refer to *Displaying the screen for system settings* on page 170.

### 2 Touch [Volume].

The “Volume Settings” screen appears.

### 3 Touch [+] or [-] to set their volume.

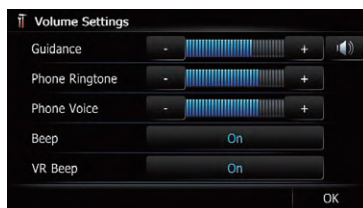

On this screen, you can operate the following items.

#### • Guidance

This setting controls the guidance volume of navigation.

- When set to guidance is output.  
When set to no guidance is output.

#### • Phone Ringtone

This setting controls the incoming ring tone volume.

#### • Phone Voice

This setting controls the incoming voice volume.

- “Phone Ringtone” and “Phone Voice” adjustments are needed only when the cellular phone featuring Bluetooth technology is connected.
- Volume of the AV source is adjusted by the **VOL (+/-)** button or Multi control.
- ➔ For details, refer to *Checking part names and functions* on page 14.

▪ If you touch the key next to “Beep”, the setting is changed.

- **On** (default):

## Customizing preferences

- A beep sounds.
- **Off:**  
The beep sound is muted.
- If you touch the key next to **"VR Beep"**, the setting is changed.
  - **On** (default):  
Voice recognition beep is enabled.
  - **Off:**  
Voice recognition beep is disabled.
- This function is available for AVIC Z140BH only.

### 4 To finish the setting, touch [OK].

## Changing the preinstalled splash screen

You can change the splash screen to the other images preinstalled in the navigation system.

### 1 Display the "System Settings" screen.

- ➔ For details, refer to *Displaying the screen for system settings* on page 170.

### 2 Touch [Splash Screen].

The "Select Splash Screen" screen appears.

### 3 Touch the image to use as the splash screen from the list.

The image is displayed on the screen.

### 4 Touch [OK].

The image is set as the splash screen, and the "System Settings" screen returns.

## Changing to the splash screen stored in the SD memory card

You can change the splash screen to other images stored in the SD memory card. Copy your chosen image to the SD memory card, and select the image to import.

- Splash screen images should be used with in the following formats;
  - BMP or JPEG files
  - Allowable horizontal and vertical size are 2 592 pixels x 1 944 pixels or smaller
  - Allowable data size is 6 MB or smaller

- Proper compatibility with allowable files is not guaranteed.
- Imported original images will be stored in the built in memory, but the ability to save these images cannot be guaranteed completely. If your original image data is deleted, insert the SD memory card again and re import the original image.
- The maximum number of images, including the images in the built in memory, that can be imported and displayed on the list is 200.

### 1 Create a folder named "Pictures" on the top-most directory of the SD memory card.

### 2 Store the picture files in the "Pictures" folder.

### 3 Insert an SD memory card into the SD card slot.

- ➔ For details of the operation, refer to *Inserting and ejecting an SD memory card* on page 18.

### 4 Display the "System Settings" screen.

- ➔ For details, refer to *Displaying the screen for system settings* on page 170.

### 5 Touch [Splash Screen].

The "Select Splash Screen" screen appears.

### 6 Touch [Select from SD].

The "Select Splash Screen" screen appears.

### 7 Touch the image to use as the splash screen from the list.

The image is displayed on the screen.

### 8 Touch [OK].

The image is set as the splash screen, and the "System Settings" screen returns.

- Images imported from the SD memory card are added to the list on "Select Splash Screen".

## Setting for rear view camera

The following two functions are available. The rear view camera feature requires a separately sold rear view camera (e.g. ND BC5). (For details, consult your dealer.)

### Rear view camera

The navigation system features a function that automatically switches to the full screen image of the rear view camera installed on your vehicle. When the shift lever is in the REVERSE (R) position, the screen automatically switches to full screen rear view camera image.

### Camera for Rear view mode

Rear view can be displayed at all times (e.g. when monitoring an attached trailer, etc.) as a split screen where map information is partially displayed. Please be aware that with this setting, camera image is not resized to fit, and that a portion of what is seen by the camera is not viewable.

➔ For details, refer to *Setting for rear view camera* on this page.

### CAUTION

Pioneer recommends the use of a camera which outputs mirror reversed images, otherwise the screen image may appear reversed.

- Immediately verify whether the display changes to a rear view camera image when the shift lever is moved to REVERSE (R) from another position.
- When the screen changes to full screen rear view camera image during normal driving, switch to the opposite setting in “Polarity”.

#### 1 Display the “System Settings” screen.

➔ For details, refer to *Displaying the screen for system settings* on page 170.

#### 2 Touch [Back Camera].

The “Back Camera Settings” screen appears.

#### 3 Touch [Camera].

This changes the setting to “On”.

- You can only switch to “Rear View” if this setting is “On”.

#### 4 Touch [Polarity] to select an appropriate setting for polarity.

Each time you touch [Polarity] switches between the following polarity:

- **Battery:** When the polarity of the connected lead is positive while the shift lever is in the REVERSE (R) position
- **GND:** When the polarity of the connected lead is negative while the shift lever is in the REVERSE (R) position

## Adjusting the response positions of the touch panel (touch panel calibration)

If you feel that the touch panel keys on the screen deviate from the actual positions that respond to your touch, adjust the response positions of the touch panel screen.

- Do not use a sharp pointed tool such as a ballpoint pen or a mechanical pen, which could damage the screen.

#### 1 Display the “System Settings” screen.

➔ For details, refer to *Displaying the screen for system settings* on page 170.

#### 2 Touch [Screen Calibration].

A message confirming whether to start the calibration appears.

#### 3 Gently touch the center of + mark displayed on the screen.

The target indicates the order.

After you touch all marks, the adjusted position data is saved.

- Do not turn off the engine while saving the adjusted position data.
- If you press the **MODE** button, the previous adjustment position returns.
- If you press and hold the **MODE** button, the adjustment is canceled.

## Customizing preferences

### Setting the illumination color

The illumination color can be selected from 8 different colors. Furthermore, the illumination color can be switched between these 8 colors in order.

### Selecting the color from the preset colors

#### 1 Display the “System Settings” screen.

- For details, refer to *Displaying the screen for system settings* on page 170.

#### 2 Touch [Illumi Color].

The “Illumination Color” screen appears.

#### 3 Touch the color you want.

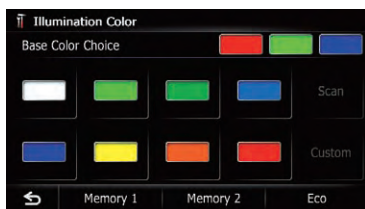

Available options:

- **Colored keys:** Selects the desired preset color
- **Memory 1/Memory 2:** Colors registered in the memory
  - For details, refer to *Creating a user defined color and storing it to memory* on this page.
- **Scan:** Shifts between the eight default colors in sequence gradually.
- **Eco:** The colors change in the order of white, red, amber, yellow, green, and blue as the number of points in the “Eco Score” increases.
  - The illumination lights in white when “Eco Score” is set to “Off” or when no route is set.

### Creating a user-defined color and storing it to memory

You can create a user defined color and set it as the illumination color.

#### 1 Display the “System Settings” screen.

- For details, refer to *Displaying the screen for system settings* on page 170.

#### 2 Touch [Illumi Color].

The “Illumination Color” screen appears.

#### 3 Touch [Custom].

The “Illumination Color” screen appears.

- If [Scan] is set, [Custom] cannot be selected.

#### 4 Touch [+] or [-] to adjust the values for Red, Green and Blue to create a favorite color.



Watch the illumination of hardware keys while adjusting the color.

Each time you touch [+] or [-] increases or decreases the value of the selected item. **+31** to **+00** is displayed as the value is increased or decreased.

- An entry cannot be stored with all of the values set to “+00”.

#### 5 Touch [Memory 1] or [Memory 2] to store the illumination color.

#### 6 Touch [OK] to return to the previous screen.

### Checking the version information

#### 1 Display the “System Settings” screen.

- For details, refer to *Displaying the screen for system settings* on page 170.

#### 2 Touch [Service Information].

The “Service Information Screen” screen appears.

#### 3 Check the version information.

## Selecting the video for rear display

You can choose either to show the same image as the front screen or to show the selected source on the rear display.

### 1 Display the AV operation screen.

- ➔ For details of the operations, refer to *Dis playing the AV operation screen* on page 74.

### 2 Tap on the left edge of the screen.

- ❑ The appearance of this key changes according to the current setting.
- ❑ While the tuner is receiving an emergency announcement, traffic announcement, or news program, the current setting cannot be changed.

Each touch of  changes the settings as follows:

- **Mirror AV:** The video on the front screen of the navigation unit is output to the rear display
- **DISC:** The video and sound of the DVDs are output to the rear display
- **iPod:** The video and sound of the iPod are output to the rear display
- **AV1:** The video and sound of **AV1** are output to the rear display
- **AV2:** The video and sound of **AV2** are output to the rear display

- ❑ When "**Mirror AV**" is selected, the following restrictions are applied to rear display.

When selecting "**Rear View**" in the map display, nothing is displayed.

All sounds cannot be output for rear display.

When playing back video files on the external storage device (USB, SD), the video image is not output.

- ❑ When "**DISC**" is selected, the following restriction is applied to rear display.

When a CD or MP3/WMA/AAC disc is set in the built-in DVD drive, only the sound is output.

- ❑ When "**iPod**" is selected, the following restriction is applied to rear display.

The video image and sound are output only when the corresponding setting on "**AV1 Input**" is "**iPod**".

- ❑ When "**AV1**" or "**AV2**" is selected, the following restrictions are applied to rear display.

The video image and sound are output only when "**AV1**" or "**AV2**" has both video and sound.

The video image and sound are output only when the corresponding setting on "**AV1 Input**" or "**AV2 Input**" are "**Video**". 

## Adjusting the picture

### CAUTION

For safety reasons, you cannot use some of these navigation functions while your vehicle is in motion. To enable these functions, you must stop in a safe place and apply the parking brake. Refer to Important Information for the User (a separate manual).

You can adjust the picture for each source and rear view camera.

### 1 Press and hold the MODE button.

The "**Picture Adjustment**" screen appears.

### 2 Touch [+ ] or [- ] to adjust the desired item.



- **Brightness:** Adjusts the black intensity.
- **Contrast:** Adjusts the contrast.
- **Color:** Adjusts the color saturation.
- **Color Temp.:** Adjusts the tone of color (which color is emphasized, red or blue).
- **Dimmer:** Adjusts the brightness of display.
- ❑ Touching [**Camera**] switches to the picture adjustment screen for the rear view camera.



## Customizing preferences

- ❑ Touching [**Source**] while adjusting the rear view camera image returns you to the previous screen.
- ❑ The adjustments of "**Brightness**" and "**Contrast**" are stored separately when your vehicle's headlights are off (daytime) and when your vehicle's headlights are on (nighttime). These are switched automatically depending on whether the vehicle's headlights are on or off.
- ❑ The adjustments of "**Dimmer**" is stored separately when your vehicle's headlights are off (daytime) and when your vehicle's headlights are on (nighttime). "**Dimmer**" is switched automatically only when the value of nighttime is lower than the value of daytime.
- ❑ You cannot adjust "**Color**" for the source without a video and navigation map display.
- ❑ The setting contents can be memorized separately for the following screen and the video image.

- **Audio source**

**AM/FM/Tuner** or **HD Radio/CD/ROM/iPod (Music)/SD (audio)/USB (audio)/Bluetooth audio/XM/SIRIUS/Pandora/aha/EXT1 (audio), EXT2 (audio)/source off screen/ menu screens/others**

- **Video source**

**AV1** and **iPod (Video)**  
**DVD-V** and **DivX**  
**SD (Video)** and **USB (Video)**  
**AV2 (Video)** and **EXT1 (Video), EXT2 (Video)**  
 Rear view camera image

- **Map screen**

- ❑ The picture adjustment may not be available with some rear view cameras.
- ❑ Because of the LCD screen characteristics, you may not be able to adjust the screen at low temperatures.

### 3 Touch [+ ] or [- ] to adjust the desired item.

Each touch of [+ ] or [- ] increases or decreases the level of the desired item.

### 4 Touch .

The previous screen returns. .

## Displaying the screen for AV system settings

1 Press the HOME button to display the "Top Menu" screen.

2 Touch [Settings].

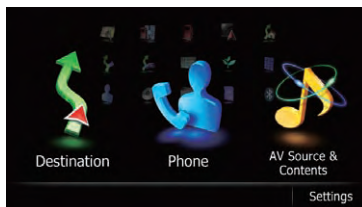

The "Settings Menu" screen appears.

3 Touch [AV Settings].

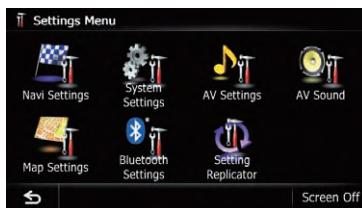

The "AV System Settings" menu appears.

4 Touch the item that you want to change the setting.

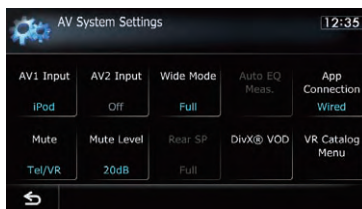

- If you touch , the previous screen returns.

## Setting video input 1 (AV1)

You can switch this setting according to the connected component.

- ❑ This setting applies to mini jack input.

## 1 Display the “AV System Settings” screen.

- ➔ For details, refer to *Displaying the screen for AV system settings* on the previous page.

## 2 Touch [AV1 Input].

Each touch of [AV1 Input] changes the setting as follows:

- **iPod:** iPod connected with the USB Inter face cable for iPod (CD IU51V) (sold separately)
- **Video:** External video component
- **Off:** No video component is connected.
- ☐ Use “AV1 Input” when connecting CD RM10 (sold separately) through the external video component.

## Setting video input 2 (AV2)

You can switch this setting according to the connected component.

- ☐ This setting applies to RCA inputs (AUDIO INPUT and VIDEO INPUT) on the back of the system.

## 1 Display the “AV System Settings” screen.

- ➔ For details, refer to *Displaying the screen for AV system settings* on the previous page.

## 2 Touch [AV2 Input].

Each touch of [AV2 Input] changes the setting as follows:

- **Off:** No video component is connected.
- **EXT:** Pioneer external unit connected with the RCA video cable
- **Video:** External video component

## Changing the wide screen mode

- ☐ You can only adjust “Wide Mode” when selecting an AV source with video.

## 1 Display the “AV System Settings” screen.

- ➔ For details, refer to *Displaying the screen for AV system settings* on the previous page.

## 2 Touch [Wide Mode].

Each touch of [Wide Mode] changes the setting as follows:

- **Full (full)**

A 4:3 picture is enlarged in the horizontal direction only, enabling you to enjoy a 4:3 TV picture (normal picture) without any omissions.

- **Cinema (cinema)**

A picture is enlarged by the same proportion as “Full” or “Zoom” in the horizontal direction and by an intermediate proportion between “Full” and “Zoom” in the vertical direction; ideal for a cinema sized picture (wide screen picture) where captions lie outside the frame.

- **Zoom (zoom)**

A 4:3 picture is enlarged in the same proportion both vertically and horizontally; ideal for a cinema sized picture (wide screen picture).

- **Normal (normal)**

A 4:3 picture is displayed normally, giving you no sense of disparity since its proportions are the same as that of the normal picture.

- ☐ Different settings can be stored for each video source.
- ☐ The same setting is automatically applied for the following grouping.
  - **DVD-V** and **DivX**
  - **AV1** and **AV2**
  - **EXT1** and **EXT2**
- ☐ When viewing videos, select an appropriate wide screen mode that matches its original aspect ratio to view it comfortably.
- ☐ Remember that use of this system for commercial or public viewing purposes may constitute an infringement on the author's rights protected by the Copyright Law.
- ☐ The followings are always viewed at “Full”.
  - Map screen
  - Rear view camera image
  - Screen of an application available for **Advanced App Mode**

## Customizing preferences

### Setting the rear output

The navigation system's rear output can be used for a full range speaker or subwoofer connection. If you switch "**Rear SP**" to "**Sub. W**", you can connect a rear speaker lead directly to a subwoofer without using an auxiliary amp.

Initially, the navigation system is set for a rear full range speaker connection ("**Full**").

- Both rear speaker leads output and RCA rear output are switched simultaneously in this setting. (When you use the product without RCA rear output, this setting only applies to the rear speaker leads.)
- "**Rear SP**" can be set only when the source is selected to "**Off**".

#### 1 Display the "AV System Settings" screen.

- For details, refer to *Displaying the screen for AV system settings* on page 177.

#### 2 Touch [Rear SP].

Each touch of [Rear SP] changes the settings as follows:

- **Full**  
When no subwoofer is connected to the rear output, select "**Full**".
- **Sub. W**  
When a subwoofer is connected to the rear output, select "**Sub. W**".

### Switching the muting/attenuation timing

You can mute the AV source volume or attenuate the output signal.

- Even if this setting is "**Off**", the navigation system will mute or attenuate the AV source volume when the mute signal is output via MUTE lead.

#### 1 Display the "AV System Settings" screen.

- For details, refer to *Displaying the screen for AV system settings* on page 177.

#### 2 Touch [Mute].

Each touch of [Mute] changes the settings as follows:

### AVIC-Z140BH

- **Guide/Tel/VR**: The volume is muted or attenuated according to the following conditions.
  - When the navigation outputs the guidance voice.
  - When you use a cellular phone via Bluetooth technology (dialing, talking, incoming call).
  - When the voice recognition mode is activated.
- **Tel/VR**: The volume is muted or attenuated according to the following conditions.
  - When you use a cellular phone via Bluetooth technology (dialing, talking, incoming call).
  - When the voice recognition mode is activated.
- **Off**: The volume does not change.

### AVIC-X940BT

- **Guide/Tel**: The volume is muted or attenuated according to the following conditions.
  - When the navigation outputs the guidance voice.
  - When you use a cellular phone via Bluetooth technology (dialing, talking, incoming call).
- **Tel**: The volume is muted or attenuated when you use a cellular phone via Bluetooth technology (dialing, talking, incoming call).
- **Off**: The volume does not change.
- AV source volume returns to normal when the corresponding action ends.

### Switching the muting/attenuation level

You can select the muting/attenuation level of "**Mute**". This setting is also effective for a mute signal that has been received from the MUTE lead connected to the navigation unit.

- This menu is not available when AV source is "**Off**".

#### 1 Display the "AV System Settings" screen.

- For details, refer to *Displaying the screen for AV system settings* on page 177.

## 2 Touch [Mute Level].

Each touch of [Mute Level] changes the settings as follows:

- **20dB:** The volume becomes 1/10.
- **10dB:** The volume becomes 1/3.
- **All:** The volume becomes 0.
- ❑ When you select "**All**", no audio adjustments are possible during the sound is turned off.
- ❑ When you select "**20dB**" or "**10dB**", no audio adjustments are possible during the sound is attenuated.
- ❑ AV source volume returns to normal when the corresponding action ends.
- ❑ Even when a mute signal has been received from MUTE lead connected to the navigation unit, navigation voice guidance cannot be attenuated or muted.

## Acquiring/Cataloging iPod music information

- ❑ This function is available for AVIC Z140BH only.

If you always set the language other than "**US English**" on "**Voice Language**", this setting is unnecessary.

Unless "**VR Catalog Mode**" is turned off, this navigation system tries to acquire the information needed to operate iPod with voice commands. It may take a short period of time to transfer the information. Change the setting according to your usage.

The navigation system starts acquiring/cataloging music information (1) when the iPod is connected or when the system boots up while the iPod is connected and (2) when iPod is the selected and displayed AV Source, unless "**VR Catalog Mode**" is turned off.

- ❑ This function is available when "**Change Control Mode**" is set to "**Navi**".
- ❑ If you do not use iPod, this setting is unnecessary.
- ❑ During transfer, the following iPod operations are not available.

Setting the shuffle play for music

Displaying the top category menu

Switching the operation screen

- ❑ Once the cataloging is completed, you can deactivate "**VR Catalog Menu**" until you update the content/data on iPod. If you update the iPod data, activate "**VR Catalog Menu**" again to transfer the music information and synchronize the music information for voice commands with the data on iPod.
- ❑ After you select "**Off**" in "**VR Catalog Mode**", the system doesn't catalog the data on the iPod. In such case, the previously cataloged data are available as voice commands.
- ❑ Once you start the cataloging process, only a few basic voice commands can be used for iPod until the process has completely finished.
- ❑ If unreadable characters are included in the data on your iPod, names or types may not be available as voice commands.

### Important Notice regarding Voice Control for iPods

Voice Control for iPods may be limited if cataloging of iPod content is not completed. Cataloging of iPod content only occurs when the system is in "**AV Source & Contents**" mode and the "**iPod**" is the selected and "**AV Source**" screen displayed. Cataloging of iPod content will not occur if the system is off, if any other "**AV Source & Contents**" is selected (aside from iPod), or if the system is in any other mode (aside from "**AV Source & Contents**" mode) such as "**Destination Menu**", "**Settings Menu**", "**Phone Menu**" or the map screen. If you wish to use Voice Control for all iPod content, it is recommended that you first connect your iPod, select "**iPod**" as the AV source, and keep the iPod screen displayed until cataloging is completed. Cataloging of iPod content should only take a few minutes, and will depend on the size of the content stored on your iPod. A message will be displayed when cataloging is complete.

## Customizing preferences

### 1 Display the “AV System Settings” screen.

- ➔ For details, refer to *Displaying the screen for AV system settings* on page 177.

### 2 Touch [VR Catalog Menu].

### 3 Touch [On] or [Off] to activate or deactivate “VR Catalog Mode”.

- If you touch [Pause], the cataloging of iPod stops.

If you want to restart the cataloging of iPod, touch [Restart].

## Displaying your DivX VOD registration code

In order to play DivX VOD (video on demand) content on this navigation system, you first need to register the unit with your DivX VOD content provider. You do this by generating a DivX VOD registration code, which you submit to your provider.

- This feature is available when the selected source is **CD**, **ROM**, **DivX**, or **DVD-V**.

### 1 Display the “AV System Settings” screen.

- ➔ For details, refer to *Displaying the screen for AV system settings* on page 177.

### 2 Touch [DivX® VOD].

The screen where you can choose to display a registration code or deregistration code is displayed.

- If a registration code has already been activated, it cannot be displayed.

### 3 Touch [Registration Code].

Your 10 digit registration code is displayed.

- Make a note of the code as you will need it when you register with a DivX VOD provider.

## Displaying your DivX VOD deregistration code

A registration code registered with a deregistration code can be deleted.

- This feature is available when the selected source is **CD**, **ROM**, **DivX**, or **DVD-V**.

### 1 Display the “AV System Settings” screen.

- ➔ For details, refer to *Displaying the screen for AV system settings* on page 177.

### 2 Touch [DivX® VOD].

The screen where you can choose to display a registration code or deregistration code is displayed.

- If a registration code has not been activated, the deregistration code is not displayed.

### 3 Touch [Deregistration Code].

Your 8 digit deregistration code is displayed.

- Make a note of the code as you will need it when you deregister with a DivX VOD provider.

## Selecting the smartphone connection method

In order to use the smartphone application on this navigation system, you need to select the method for connecting your smartphone.

- ➔ For details, refer to *Starting procedure* on page 131.

## Displaying the screen for AV sound settings

### 1 Press the HOME button to display the “Top Menu” screen.

### 2 Touch [Settings].

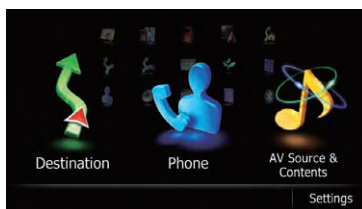

The “Settings Menu” screen appears.

### 3 Touch [AV Sound].

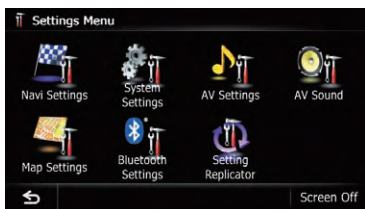

The “AV Sound Settings” screen appears.

- You cannot make adjustments in the following situations:
  - AV source is “Off”.
  - During muting/attenuation

### 4 Touch the item that you want to change the setting.



- If you touch , the previous screen returns.

## Using balance adjustment

You can select a fader/balance setting that provides an ideal listening environment in all occupied seats.

### 1 Display the “AV Sound Settings” screen.

- For details, refer to *Displaying the screen for AV sound settings* on the previous page.

### 2 Touch [FAD/BAL].

When “Sub. W” is selected in “Rear SP”, [Balance] will be displayed instead of [FAD/BAL] and front/rear speaker balance cannot be adjusted.

- For details, refer to *Setting the rear output* on page 179.

### 3 Touch [▲] or [▼] to adjust front/rear speaker balance.

Each time you touch [▲] or [▼], the front/rear speaker balance moves towards the front or the rear.

“Front: 15” to “Rear: 15” is displayed as the front/rear speaker balance moves from front to rear.

Set “Front:” and “Rear:” to “0” when using a two speaker system.

### 4 Touch [◀] or [▶] to adjust left/right speaker balance.

Each time you touch [◀] or [▶], the left/right speaker balance moves towards the left or the right.



“Left: 15” to “Right: 15” is displayed as the left/right speaker balance moves from left to right.

## Using the equalizer

The equalizer lets you adjust equalization to match vehicle interior acoustic characteristics as desired.

### Recalling equalizer curves

There are seven stored equalizer curves that you can easily recall at any time. Here is a list of the equalizer curves:

#### Equalizer curve

**S.Bass** (Super Bass) is a curve in which only low pitched sound is boosted.

**Powerful** is a curve in which low pitched and high pitched sounds are boosted.

**Natural** is a curve in which low pitched and high pitched sounds are slightly boosted.

# Customizing preferences

## Equalizer curve

**Vocal** is a curve in which the midrange, which is the human vocal range, is boosted.

**Flat** is a flat curve in which nothing is boosted.

**Custom1** is an adjusted equalizer curve that you create. A separate custom curve can be created for each source.

**Custom2** is an adjusted equalizer curve that you create. If you select this curve, the effect is reflected all AV source.

- When **"Flat"** is selected, no supplement or correction is made to the sound. This is useful to check the effect of the equalizer curves by switching alternatively between **"Flat"** and a set equalizer curve.
- You cannot select **"Custom1"** and **"Custom2"** when **"Auto EQ"** is **"On"**.
  - ➔ For details, refer to *Using the auto adjusted equalizer* on the next page.

### 1 Display the "AV Sound Settings" screen.

- ➔ For details, refer to *Displaying the screen for AV sound settings* on page 181.

### 2 Touch [EQ].

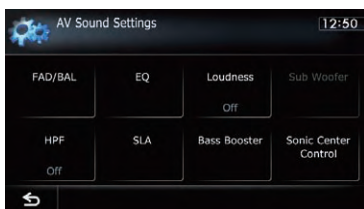

### 3 Touch the equalizer you want.

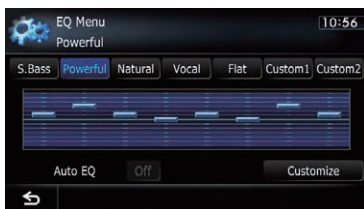

- If **Auto EQ** has been set to **"On"**, an image corresponding to each equalizer curve you selected appears.

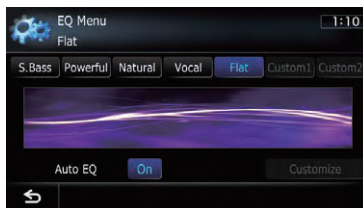

- ➔ For details of the operations, refer to *Adjusting the equalizer curve automatically (Auto EQ)* on the next page.

## Customizing the equalizer curves

You can adjust the currently selected equalizer curve setting as desired. Adjustments can be made with a 8 band graphic equalizer.

- This function is not available when **"Auto EQ"** is **"On"**.
  - ➔ For details, refer to *Using the auto adjusted equalizer* on the next page.

### The difference between "Custom1" and "Custom2"

- A separate **"Custom1"** curve can be created for each source. If you make adjustments when a curve **"S. Bass (Super Bass)"**, **"Powerful"**, **"Natural"**, **"Vocal"**, **"Flat"**, or **"Custom1"** is selected, the equalizer curve settings will be memorized in **"Custom1"**.
- A **"Custom2"** curve can be created common to all sources. If you make adjustments when **"Custom2"** curve is selected, the **"Custom2"** curve will be updated.
- The **"Custom1"** curve is applied to each of the source selected, but you can apply the same curve to the following sources.

**AM** and **FM**

**EXT1** and **EXT2**

**AV1** and **AV2**

**CD**, **ROM**, **DVD-V**, and **DivX**

**SD** and **USB**

**Audio** (Bluetooth audio), **Pandora** (Bluetooth connection) and **aha** (Bluetooth connection)

**iPod**, **Pandora** (iPhone) and **aha** (iPhone)

- The different curve can be memorized between **iPod** and **USB**.

### 1 Display the “AV Sound Settings” screen.

- ➔ For details, refer to *Displaying the screen for AV sound settings* on page 181.

### 2 Touch [EQ].

### 3 Touch one of the keys to select a curve that you want to use as the basis of customizing.

### 4 Touch [Customize].

### 5 Touch the frequency that you want to adjust the level.

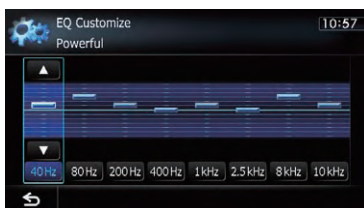

### 6 Touch [▲] or [▼] to adjust the level of the equalizer band.

Each time you touch [▲] or [▼], the level of the equalizer band increases or decreases.

## Using the auto-adjusted equalizer

You can set the auto adjusted equalizer to suit the vehicle's acoustics. To use this function, the vehicle's acoustics must be measured in advance.

- ➔ For details of the operations, refer to *Adjusting the equalizer curve automatically (Auto EQ)* on this page.
- To manually adjust the equalizer curve, set “Auto EQ” to “Off”.

### 1 Display the “AV Sound Settings” screen.

- ➔ For details, refer to *Displaying the screen for AV sound settings* on page 181.

### 2 Touch [EQ].

### 3 Touch the key next to “Auto EQ” to turn the auto-adjusted equalizer on or off.

### 4 Select the equalizer curve.

## Adjusting the equalizer curve automatically (Auto EQ)

By measuring the vehicle's acoustics, the equalizer curve can be adjusted automatically to suit the interior of the vehicle.

### ! WARNING

A loud tone (noise) may be emitted from the speakers when measuring the vehicle's acoustics. Never perform the Auto EQ measurement while driving.

### ! CAUTION

- Thoroughly check the conditions before performing Auto EQ, as the speakers may be damaged if this is performed under the following conditions:

When the speakers are incorrectly connected. (For example, when a rear speaker is connected as a subwoofer output.)

When a speaker is connected to a power amp delivering output higher than the speaker's maximum input power capability.

- If the microphone for acoustical measurement (sold separately) is not placed in an appropriate location, the measurement tone may become loud and measurement may take a long time, resulting in battery drainage. Be sure to place the microphone in the specified location.

## Before operating the Auto EQ function

- Perform Auto EQ in as quiet a place as possible, with the vehicle engine and air conditioning switched off. Also, cut power to car phones or cellular phones in the vehicle, or remove them from the vehicle before performing Auto EQ. Sounds other than the measurement tone (surrounding sounds, engine sound, telephones ringing, etc.) may prevent correct measurement of the vehicle's acoustics.



## Customizing preferences

- Be sure to perform Auto EQ using the microphone for acoustical measurement (sold separately). Using another microphone may prevent measurement, or result in incorrect measurement of the vehicle's acoustics.
- To perform Auto EQ, the front speakers must be connected.
- When this navigation system is connected to a power amp with input level control, Auto EQ may not be able to be performed if the power amp's input level is set below the standard level.
- When this navigation system is connected to a power amp with an LPF, turn the LPF off before performing Auto EQ. Also, set the cut off frequency for the built in LPF of an active subwoofer to the highest frequency.
- The distance has been calculated by computer to provide the optimum delay to ensure accurate results. Do not change this value.

The reflected sound within the vehicle is strong and delays occur.

The LPF on active subwoofers or external amps delay the lower sounds.

- If an error occurs during measurement, a message appears and measurement is canceled. Check the following before measuring the vehicle's acoustics.

Front speakers (left/right)

Rear speakers (left/right)

Noise

Microphone for acoustical measurement (sold separately)

Low battery

### Performing Auto EQ

- ❑ Auto EQ changes the audio settings as follows:
  - "Auto EQ" on the "EQ Menu" screen is set to "On".
    - ➡ For details, refer to *Using the auto ad justed equalizer* on the previous page.
  - The fader/balance settings return to the center position.

- ➡ For details, refer to *Using balance ad justment* on page 182.

- The equalizer curve switches to "Flat".
  - ➡ For details, refer to *Using the equalizer* on page 182.
- The front and rear speakers will automatically be adjusted to a high pass filter setting.

- ❑ Previous settings for Auto EQ will be overwritten.
- ❑ For AVIC Z140BH users  
Do not press the ▲ button to open or close the panel when you are using the microphone.

### 1 Stop the vehicle in a place that is quiet, close all the doors, windows and sun roof, and then turn the engine off.

If the engine is left running, engine noise may prevent correct Auto EQ.

- ❑ If driving restrictions are detected during measurement, measurement is canceled.

### 2 Fix the microphone for acoustical measurement (sold separately) in the center of the headrest of the driver's seat, facing forward.

The Auto EQ may differ depending on where you place the microphone. If desired, place the microphone on the front passenger seat and perform Auto EQ.

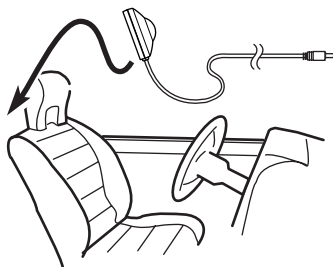

### 3 Turn the ignition switch to ON or ACC.

If the vehicle's air conditioner or heater is turned on, turn it off. Noise from the fan in the air conditioner or heater may prevent correct Auto EQ.

**4 Switch the AV source to "Off".**

- ☞ For details of the operations, refer to *Displaying the AV operation screen* on page 74.

**5 Set the video setting for the rear display to "Mirror AV".**

- ☞ For details of the operations, refer to *Selecting the video for rear display* on page 176.

**6 Display the "AV System Settings" screen.**

- ☞ For details, refer to *Displaying the screen for AV system settings* on page 177.

**7 Touch [Auto EQ Meas.].**

The "Auto EQ Measurement" screen appears.

**8 Plug the microphone into the mini-jack connector.**

USB and mini jack connector

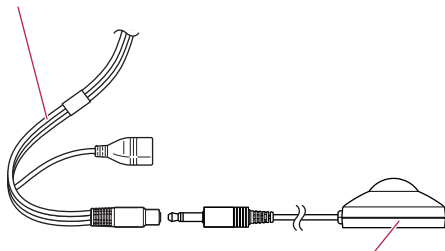

Microphone for acoustical measurement (sold separately)

**9 Touch [Start].**

A 10 second countdown starts.

**10 Exit the vehicle and keep the door closed until the countdown finishes.**

When the countdown is over, a measurement tone (noise) is emitted from the speakers and the Auto EQ measurement begins.

**11 Wait until the measurement is completed.**

When Auto EQ is completed, a message is displayed indicating that the measurement is completed.

- ☐ If the vehicle's acoustics cannot be measured correctly, an error message will be displayed.

- ☐ The measurement time varies depending on the type of vehicle.
- ☐ To stop the measurement, touch [Stop].

**12 Touch [OK].****13 Store the microphone carefully in the glove compartment or another safe place.**

If the microphone is subjected to direct sun light for an extended period of time, high temperatures may cause distortion, color change or malfunction.

**Using sonic center control**

Sound that is suited for the listening position can easily be created with this function.

**1 Display the "AV Sound Settings" screen.**

- ☞ For details, refer to *Displaying the screen for AV sound settings* on page 181.

**2 Touch [Sonic Center Control].****3 Touch [◀] or [▶] to select a listening position.**

- ☐ The larger the value of the range: "Left7" to "Right7" setting, the greater the delay of the speaker output.
- ☐ When "Left" is set, the left speaker output is delayed. When "Right" is set, the right speaker output is delayed.

**Adjusting loudness**

Loudness compensates for deficiencies in the low and high sound ranges at low volume.

**1 Display the "AV Sound Settings" screen.**

- ☞ For details, refer to *Displaying the screen for AV sound settings* on page 181.

**2 Touch [Loudness].**

Each time you touch [Loudness], the level is selected in the following order:

**Off Low Mid High**

## Customizing preferences

### Using subwoofer output

The navigation system is equipped with a subwoofer output mechanism, which can be turned on or off.

- This function is not available when "Sub Woofer" is "Off".

#### 1 Display the "AV Sound Settings" screen.

- ➔ For details, refer to *Displaying the screen for AV sound settings* on page 181.

#### 2 Touch [Sub Woofer].

#### 3 Touch [On].

The subwoofer output is turned on.



- If you touch [Off], the subwoofer output is turned off.

#### 4 Touch [Reverse] or [Normal] to select the phase of subwoofer output.

#### 5 Touch [+] or [-] next to "Level" to adjust the output level.

"+6" to "-24" is displayed as the level is increased or decreased.

#### 6 Touch [◀] or [▶] next to "Frequency(Hz)" to select cut-off frequency.

Each time you touch [◀] or [▶], cut off frequencies are selected in the following order:

**50Hz 63Hz 80Hz 100Hz 125Hz**

Only frequencies lower than those in the selected range are output from the subwoofer.

### Using the high pass filter

When you cut lower sounds from the subwoofer output frequency, activate **HPF** (high pass filter). Only frequencies higher than those in

the selected range are output from the front or rear speakers.

#### 1 Display the "AV Sound Settings" screen.

- ➔ For details, refer to *Displaying the screen for AV sound settings* on page 181.

#### 2 Touch [HPF].

Each time you touch [HPF] selects cut off frequencies in the following order:

**Off 50Hz 63Hz 80Hz 100Hz 125Hz**

### Adjusting source levels

**SLA** (source level adjustment) lets you adjust the volume level of each source to prevent radical changes in volume when switching between sources.

- Settings are based on the FM tuner volume level, which remains unchanged.
- You cannot select [SLA] when the FM tuner is selected as the AV source.

#### 1 Compare the FM tuner volume level with the level of the source you wish to adjust.

#### 2 Display the "AV Sound Settings" screen.

- ➔ For details, refer to *Displaying the screen for AV sound settings* on page 181.

#### 3 Touch [SLA].

#### 4 Touch [+] or [-] to adjust the source volume.

"+8dB" to "-8dB" is displayed as the source volume is increased or decreased.

The following AV sources are set to the same source level adjustment volume automatically.

- **CD, ROM, and DivX**
- **SD and USB**
- **Audio** (Bluetooth audio), **Pandora** (Bluetooth connection) and **aha** (Bluetooth connection)
- **Audio** (Bluetooth audio), **Pandora** (Bluetooth connection) and **aha** (Bluetooth connection)
- **AV1 and AV2**

- **EXT1** and **EXT2**
- The different source volume level can be set between **iPod** and **USB**.

## Enhancing bass (Bass Booster)

You can enhance bass sounds that are often muted by driving noise.

### 1 Display the “AV Sound Settings” screen.

- ↻ For details, refer to *Displaying the screen for AV sound settings* on page 181.

### 2 Touch [Bass Booster].

### 3 Touch [+ ] or [- ] to adjust the range from 0 to 6.

## Replicating the settings

You can import settings you have made on the utility program AVIC FEEDS which is available separately to the navigation system.

### 1 Use AVIC FEEDS to replicate the settings and store them on an SD memory card.

### 2 Insert an SD memory card into the SD card slot.

- ↻ For details of the operation, refer to *Inserting and ejecting an SD memory card* on page 18.

### 3 Press the HOME button to display the “Top Menu” screen.

### 4 Touch [Settings].

The “Settings Menu” screen appears.

### 5 Touch [Setting Replicator].

A message confirming whether to update the settings appears.

### 6 Touch [Yes].

Update starts.

After the settings are updated, a message confirming whether to restart the navigation system appears.

### 7 Touch [OK].

The navigation system restarts.

## Turning off the screen

By turning off the backlight of the LCD screen, you can turn off the screen display without turning off the voice guidance.

### 1 Press the HOME button to display the “Top Menu” screen.

### 2 Touch [Settings].

The “Settings Menu” screen appears.

### 3 Touch [Screen Off].

The screen is turned off.

- Touch anywhere on the screen to turn it back on.

## Operating your navigation system with voice

- ❑ This function is available for AVIC Z140BH only.

### To Ensure Safe Driving

#### ⚠ CAUTION

For your safety, avoid viewing the screen in the voice operation as much as possible while driving.

If you use voice operation, select "US English" or "US English (Samantha):TTS" in "Voice Language" of "Regional Settings". If you select other languages, voice operation will not be available.



### Basics of the voice operation

Your Pioneer navigation system uses the latest in voice recognition technology. You can use voice commands to operate many of its functions. This chapter describes where you can use voice commands, and also what commands the system accepts.

You can use voice commands to operate the following functions:

- Hands free phoning
  - Switching the AV source
  - Operating the iPod
- ❑ This function is not available while cataloging of iPod is in progress.

### Flow of the voice operation

You can start the voice operation any time even when the map screen is displayed or AV is operating. (Some operations are not available.) The basic steps of the voice operations are as follows.

- 1 Switch the screen to map screen or AV operation screen.
- ↓
- 2 Press the button to activate voice operations.
- ↓
- 3 Speak a command into the microphone after the beep.  
When the command is recognized, the navigation system displays next options on the screen, and pronounces it in some cases.
- ↓
- 4 Repeat previous step as necessary.
- ↓
- 5 The requested operation will be carried out.

- ❑ The voice operation may not be operable for a minute after the navigation system has booted up.
- ❑ The voice operation will be activated 30 seconds after the map screen is displayed. If the button does not respond, display the disclaimer screen and then touch [OK]. The map screen is displayed.

### Starting the voice operation

- Press the button when the map screen or the AV operation screen is displayed.

The voice operation screen appears.

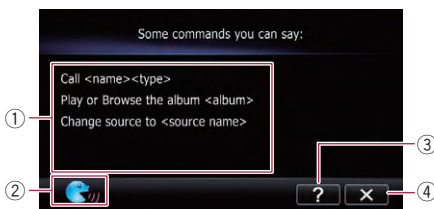

#### ① Voice help menu

Displays a list of commands for the voice operation.

### ② Voice operation condition indicator

When  is indicated, the navigation system can recognize your voice commands.

### ③

Touch to listen to the brief operating instruction.

### ④

Touch to cancel the voice operation.

- You can cancel the voice operation feature at any time by saying "Cancel". After you cancel voice operations, the display returns to the screen displayed before the voice operation screen appeared.

**2 Press the  button to activate voice operations.**

**3 Say "Change Source" to display the AV source selection screen.**

**4 Say "iPod" on the selection screen to switch the AV source to iPod.**

- Touching the item on the screen also enables you to select the desired AV source.

**5 Press the  button to activate voice operations.**

**6 Say "Play the album Pioneer" to playback the album name "Pioneer".**

If the command is recognized properly, playback starts from the first song of "Pioneer". 

## How to use the voice operation

### Calling the entry on the phone book

A method for dialing the entry named "Nancy" is described here along with an operational example.

**1 Press the MODE button to display the map screen or the AV operation screen.**

**2 Press the  button to activate voice operations.**

**3 Say "Call Nancy" to make a call.**

A message confirming whether to dial appears.

**4 Say "Yes".**

Dialing starts.

### Operating iPod by voice

You can play music using voice operation from the iPod connected to the navigation system.

- To use the content/data on the iPod for voice operation, transfer the data to this system first.

➔ For details, refer to *Acquiring/Cataloging iPod music information* on page 180.

Examples of voice operation of the iPod are shown below. (A method for playing the album title named "Pioneer" is described here, along with an operational example.)

**1 Press the MODE button to display the map screen or the AV operation screen.**

## Operating your navigation system with voice

### Available basic voice commands

The navigation system can also recognize the words in the following list.

- Terms written in italics are voice commands.

### Basic commands

#### Voice commands and operations

*Back* → The previous screen returns.

*Cancel* → Cancels the voice operation.

*Help* → Outputs the brief operating instruction by voice.

*Next page, Previous page* → Switches the page.

*Last page, First page* → Switches to the last or first page.

### Voice operation for the iPod

For <Artist name>, <Album name>, <Playlist name>, <Genre name> shown on the following chart, say the name stored in the iPod.

- Playback of iPod movies is not available using voice commands.

#### Voice commands and operations

*Shuffle play* → Plays all songs randomly.

*Resume* → Resumes the song or the video currently playing.

*Pause* → Pauses the song or the video currently playing.

*Next song* → Plays the next song.

*Previous song* → Plays the previous song or returns to the beginning of the song currently playing.

*Play songs* → Starts playback from the top of "**Songs**".

*Play artists* → Displays the artist list → Say the artist name that you want to play.

*Play the artist <Artist name>* → Starts playback from the top of the selected artist.

*Play albums* → Displays the album list → Say the album title that you want to play.

*Play the album <Album name>* → Starts playback from the top of the selected album.

*Play playlists* → Displays the playlist → Say the playlist that you want to play.

*Play the playlist <Playlist name>* → Starts playback from the top of the selected playlist.

*Play genres* → Displays the genre list → Say the genre that you want to play.

*Play the genre <Genre name>* → Starts playback from the top of the selected genre.

*Browse artists* → Displays the artist list together with sub screen to continue the voice operation. → Say desired voice commands.

*Browse the artist <Artist name>* → Displays the album list of the selected artist together with sub screen to continue the voice operation. → Say desired voice commands.

*Browse albums* → Displays the album list together with sub screen to continue the voice operation. → Say the desired voice commands.

*Browse the album <Album name>* → Displays the song list of the selected album together with sub screen to continue the voice operation. → Say desired voice commands.

**Voice commands and operations**

*Browse playlists* → Displays the playlist together with sub screen to continue the voice operation. → Say the desired voice commands.

*Browse the playlist <Playlist name>* → Displays the song list of the selected playlist together with sub screen to continue the voice operation. → Say desired voice commands.

*Browse genre* → Displays the genre list together with sub screen to continue the voice operation. → Say the desired voice commands.

*Browse the genre <Genre name>* → Displays the song list of the selected genre list together with sub screen to continue the voice operation. → Say desired voice commands.

*Play more music artist* → Plays the songs related to the currently playing artist.

*Play more music album* → Plays the songs related to the currently playing album.

*Play more music genre* → Plays the songs related to the currently playing genre.

*Next page, Previous page* → Displays the previous or next page of the selection list. (\*1)

*First page, Last page* → Displays the first or last page of the selection list. (\*1)

(\*1) Voice commands are available only when the selection list is displayed.

**Voice operation for AV source (other than iPod)****AV source selection****Voice commands and operations**

*Change Source to DISC* → Switches the AV source to **Disc**.

*Change Source to Tuner* → Switches the AV source to **Tuner**.

*Change Source to XM Satellite Radio* → Switches the AV source to **XM**.

*Change Source to SIRIUS Satellite Radio* → Switches the AV source to **SIRIUS**.

*Change Source to SD* → Switches the AV source to **SD**.

*Change Source to USB* → Switches the AV source to **USB**.

*Change Source to iPod* → Switches the AV source to **iPod**.

*Change Source to Bluetooth Audio* → Switches the AV source to **Audio** (Bluetooth audio).

**Built-in DVD drive, external storage device (USB, SD)****Voice commands and operations**

*Shuffle play* → Plays all songs randomly.

*Pause* → Pauses the track or file currently playing.

*Resume* → Resumes the track or file currently playing.

*Next song* → Plays the next track or file.

*Previous song* → Plays the previous track or file, or returns to the beginning of the track or file currently playing.



## Operating your navigation system with voice

### Voice commands related to hands-free phoning

- ❑ You can make a phone call by voice dialing if the cellular phone featuring Bluetooth wireless technology is being paired with the navigation system.
- ❑ For <entry's name> shown on the following chart, say the name of the entry stored in "Contacts".
- ❑ For <phone number> shown on the following chart, say the desired phone number.

#### Voice commands and operations

*Call <entry's name>* → Makes a call to the entry (\*2).

*Call <entry's name> general* → Displays the message confirming whether to dial → Say *Yes* → Dials the general phone number of the entry (\*3).

*Call <entry's name> mobile* → Displays the message confirming whether to dial → Say *Yes* → Dials the cellular phone number of the entry (\*3).

*Call <entry's name> home* → Displays the message confirming whether to dial → Say *Yes* → Dials the home phone number of the entry (\*3).

*Call <entry's name> work* → Displays the message confirming whether to dial → Say *Yes* → Dials the office phone number of the entry (\*3).

*Call <entry's name> other* → Displays the message confirming whether to dial → Say *Yes* → Dials the other phone number of the entry (\*3).

*Call <phone number>* → Displays the message confirming whether to dial → Say *Yes* → Dials the phone number.

*Make a call* → Say the phone number you want to call → Displays the message confirming whether to dial → Say *Yes* → The system starts dialing to the number.

*Make a call* → Say the name of entry stored on "Contacts" you want to call → Displays the message confirming whether to dial → Say *Yes* → The system starts dialing to the number (\*2).

*List outgoing calls* → Display the list of recent outgoing calls ("Dialed Calls") to select the number and call (\*4).

*List recent calls* → *Incoming calls* → Display the list of recently received calls ("Received Calls") to select the number and call (\*4).

*List recent calls* → *Outgoing calls* → Display the list of recent outgoing calls ("Dialed Calls") to select the number and call (\*4).

*List recent incoming calls* → Display the list of recently received calls ("Received Calls") to select the number and call (\*4).

*Find the nearest* → Displays the category list → Say the category that you want to set to your destination → Displays the list of candidates with number → *Show me details for <the number that you want to select>* → *Call* → Dialing starts.

(\*2) If the entry has multiple phone number data, selection list may appear. In such case, say the type of phone number.

(\*3) If there is no corresponding type on the entry, the system may suggest you other phone numbers of the entry. In such case, say the type of phone number.

(\*4) Touching the item on the screen also enables you to select the desired list.



## Tips for the voice operation

For your voice commands to be correctly recognized and interpreted, ensure that conditions are suitable for recognition.

### Close the vehicle windows

Please note that wind through the vehicle window or miscellaneous noise from outside the vehicle can interfere with voice operation.

### Position the microphone carefully

For optimum pick up, the microphone should be fixed at a suitable distance directly in front of the driver.

### Pause before giving a command

Speaking too soon may cause the recognition to fail.

### Pronounce your commands carefully

Speak slowly, deliberately, and clearly. 

## Other functions

### Setting the anti-theft function

You can set a password for the navigation system. If the back up lead is cut after the password is set, the navigation system prompts for the password at the time of next boot up.

### Setting the password

**1 Press the HOME button to display the "Top Menu" screen.**

**2 Touch [Settings].**

The "Settings Menu" screen appears.

- This can also be operated using the "Short cut Menu" screen.

**3 Touch Area1, followed by Area2, and then touch and hold Area3.**

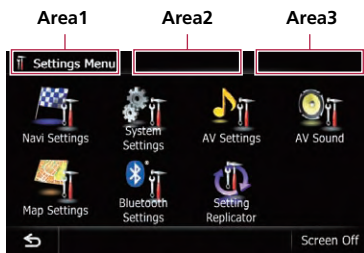

**4 Touch [Set Password].**

The password setting screen appears.

**5 Enter the password you want to set.**

- 5 to 16 characters can be entered for a password.

**6 Touch [OK].**

**7 Reenter the password to confirm the setting.**

**8 Touch [OK].**

Password protection is applied.

- If you want to change the password currently set, enter the current password and then enter the new one.

### Entering the password

On the password input screen, you must enter the current password. If you enter an incorrect password three times, the screen is locked and operations using touch panel keys are disabled.

**1 Enter the password.**

**2 Touch [OK].**

If you enter the correct password, the navigation system will be unlocked.

### Deleting the password

The current password can be deleted.

**1 Press the HOME button to display the "Top Menu" screen.**

**2 Touch [Settings] on the "Top Menu".**

**3 Touch Area1, followed by Area2, and then touch and hold Area3.**

**4 Touch [Clear password].**

The password setting screen appears.

**5 Enter the current password.**

**6 Touch [OK].**

**7 Touch [Yes].**

The message for deletion appears and then the current password is deleted.

### Forgotten password

Contact the nearest authorized Pioneer Service Station.

## Returning the navigation system to the default or factory settings

You can return settings or recorded content to the default or factory settings. There are some methods to clear user data, and the situations and the cleared content are different for each method. For information regarding the content that is cleared by each method, see the list presented later.

### Method 1: Remove the vehicle battery

This transforms the system into the same state as when the navigation system is unin- stalled.

### Method 2: Touch [Restore Factory Settings]

➤ For details, refer to *Restoring the default set- ting* on this page.

### Method 3: Touch [Clear user information] on the “Select Items to Reset” screen

➤ For details, refer to *Returning the navigation system to the initial state* on this page.

### Method 4: Touch [Reset] on the “Select Items to Reset” screen

➤ For details, refer to *Returning the navigation system to the initial state* on this page.

## Restoring the default setting

Resets various settings registered to the navi- gation system and restores them to the default or factory settings.

Be sure to read “*Setting items to be deleted*” before you perform this operation.

➤ For details, refer to *Setting items to be deleted* on the next page.

### 1 Display the “System Settings” screen.

➤ For details, refer to *Displaying the screen for system settings* on page 170.

### 2 Touch [Restore Factory Settings].

The message confirming whether to restore the settings appears.

### 3 Touch [Yes].

## Returning the navigation system to the initial state

You can return settings or recorded content to the default or factory settings.

Be sure to read “*Setting items to be deleted*” before you perform this operation.

➤ For details, refer to *Setting items to be deleted* on the next page.

### 1 Park your vehicle in a safe place and apply the parking brake.

### 2 Turn the ignition switch off and back on.

The navigation system restarts, and the splash screen appears.

### 3 Press and hold the MODE button and the TRK (◀▶) button while the splash screen appears.

For users of AVIC Z140BH, press the **MODE** button and the **TRK** (◀) button.

The “**Select Items to Reset**” screen appears.

### 4 Touch [Clear user information] or [Reset].

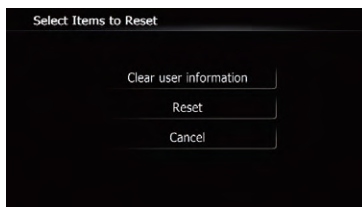

The message confirming whether to erase the data appears.

### 5 Touch [Yes].

The recorded contents are cleared.

## Other functions

### Setting items to be deleted

The items to be deleted vary depending on the reset method. The items listed in the following table return to the default or factory settings. Any items not listed below will be retained.

○: The setting will be retained.

✓: The setting will be cleared and returned to the default or factory settings.

□: Bold indicates functions or command names.

- **Method 1: Remove the vehicle battery**
- **Method 2: Touch [Restore Factory Settings]**
- **Method 3: Touch [Clear user information] on the "Select Items to Reset" screen**
- **Method 4: Touch [Reset] on the "Select Items to Reset" screen**

Navigation functions		Method 1	Method 2	Method 3	Method 4
Map function	View mode and scale setting on the map			✓	✓
	Direction of the map			✓	✓
	Last cursor position on the map screen		✓	✓	✓
Route setting	Current route	✓		✓	✓
	Guidance state of the current route			✓	✓
	Vehicle position information			✓	✓
	<b>Options</b>		✓	✓	✓
Others	Keyboard		✓	✓	✓
	Learnt data used in <b>Learning Route</b>	✓		✓	✓
	Shortcut Menu		✓	✓	✓
Destination	Point registered in <b>Favorites</b>			✓	
	<b>History</b>			✓	
	Stored city history			✓	
<b>Traffic Settings</b>	<b>Displayed Traffic Info</b>		✓	✓	✓
<b>Map Settings</b>	<b>View Mode</b>			✓	✓
	Other settings		✓	✓	✓
<b>Navi Settings</b>	<b>3D Calibration Status</b>				
	<b>Demo Mode</b>	✓	✓	✓	✓
	<b>Set Home</b>			✓	
	<b>Modify Current Location</b>			✓	✓
	Other settings		✓	✓	✓

Navigation functions		Method 1	Method 2	Method 3	Method 4
System Settings	<b>Program Language, Voice Language</b>			✓	✓
	<b>Time</b>			✓	✓
	<b>Back Camera</b>	✓			
	Other settings		✓	✓	✓
<b>Bluetooth Settings</b>	All settings (*1)		✓	✓	✓
<b>Phone Menu</b>	All settings (*1)		✓	✓	✓
Other functions	Anti theft password				

(\*1) All stored data of 5 users is deleted.

AV functions		Method 1	Method 2	Method 3	Method 4
	Volume	✓			
AV Settings	<b>Wide Mode, Mute, VR Catalog Menu</b>	✓		✓	✓
	Other settings	✓			
<b>AV Sound</b>	All settings	✓			
<b>CD, ROM, DVD-V, DivX, FM, AM, Audio</b> (Bluetooth audio)	All settings (*2)	✓			
<b>SD, USB</b>	All settings (*2)	✓		✓	✓
Other functions	<b>Picture Adjustment</b>	✓			
	<b>Tilt</b>	✓			

(\*2) All settings including the setting on the "Function" menu are deleted.



# Appendix

## Troubleshooting

If you have problems operating your navigation system, refer to this section. The most common problems are listed below, along with likely causes and solutions. If a solution to your problem cannot be found here, contact your dealer or the nearest authorized Pioneer service facility.

### Problems with the navigation screen

Symptom	Cause	Action (Reference)
The power doesn't turn on. The navigation system doesn't operate.	Leads and connectors are incorrectly connected.	Confirm once more that all connections are correct.
	The fuse is blown.	Rectify the reason for the fuse blowing, then replace the fuse. Be very sure to install a correct fuse with the same rating.
	Noise and other factors are causing the built in microprocessor to operate incorrectly.	Park your vehicle in a safe place, and turn off the engine. Turn the ignition key back to off (ACC OFF). Then start the engine again, and turn the power to the navigation system back on.
You cannot position your vehicle on the map without a significant positioning error.	The GPS antenna is in an unsuitable location.	The quality of signals from the GPS satellites is poor, causing reduced positioning accuracy. Check the GPS signal reception and the position of the GPS antenna if necessary.
	Obstacles are blocking signals from the satellites.	The quality of signals from the GPS satellites is poor, causing reduced positioning accuracy. Check the GPS signal reception and the position of the GPS antenna if necessary, or continue driving until reception improves. Keep the antenna clean.
	The position of satellites relative to your vehicle is inadequate.	The quality of signals from the GPS satellites is poor, causing reduced positioning accuracy. Continue driving until reception improves.
	Signals from the GPS satellites have been modified to reduce accuracy. (GPS satellites are operated by the US Department of Defense, and the US government reserves the right to distort positioning data for military reasons. This may lead to greater positioning errors.)	The quality of signals from the GPS satellites is poor, causing reduced positioning accuracy. Wait until reception improves.
	If a vehicle phone or cellular phone is used near the GPS antenna, GPS reception may be lost temporarily.	The quality of signals from the GPS satellites is poor, causing reduced positioning accuracy. When using a cellular phone, keep the antenna of the cellular phone away from the GPS antenna.

# Appendix

Symptom	Cause	Action (Reference)
You cannot position your vehicle on the map without a significant positioning error.	Something covers the GPS antenna.	Do not cover the GPS antenna with spray paint or vehicle wax, because this may block the reception of GPS signals. Snow buildup can also degrade the signals.
	Signals from the vehicle's speed pulse are not being picked up properly.	Check that the cables are properly connected. If necessary, consult the dealer that installed the system.
	The navigation system may not be mounted securely in your vehicle.	Check that the navigation system is securely mounted and, if necessary, consult the dealer that installed the system.
	The navigation system is installed with an extreme angle exceeding the installation angle limitations.	Confirm the installation angle. (The navigation system must be installed within the allowed installation angle. For details, refer to Installation Manual.)
	Indication of the position of your vehicle is misaligned after a U turn or reversing.	Check whether or not the reverse gear signal input lead (violet) is connected properly. (The navigation system works properly without the lead connected, but positioning accuracy will be adversely affected.)
"Eco Graph" is not available.	The navigation system is unable to obtain past average fuel mileage data, so "Eco Graph" cannot be displayed.	Drive about 10 km on a road without obstructions. Then park your vehicle in a safe place, turn off the navigation system and turn the power to the navigation system back on.
The map color does not switch automatically between daytime and nighttime.	"Day/Night Display" is set to "Day".	Check "Day/Night Display" setting and make sure "Automatic" is selected. (Page 168)
	The orange/white lead is not connected.	Check the connection.
The screen is too bright.	Picture quality adjustment of the display is not correct.	Adjust the picture quality. (Page 176)
The display is very dim.	The vehicle's light is turned ON, and "Automatic" is selected on "Day/Night Display".	Read about "Day/Night Display" setting and, if desired, select "Day". (Page 168)
	Picture quality adjustment of the display is not correct.	Adjust the picture quality. (Page 176)
No sounds of AV source are produced. The volume level will not rise.	The volume level is low.	Adjust the volume level.
	The attenuator or mute is on.	Turn the attenuator or mute off.
	A speaker lead is disconnected.	Check the connection.
The volume of navigation guidance and beeps cannot be adjusted.	<b>VOL (+/ -)</b> button or Multi control is used to adjust the volume.	Turn the volume up or down using "Volume" on the "System Settings" menu. (Page 172)
The person on the other end of the phone call cannot hear the conversation due to an echo.	The voice from the person on the other end of the phone call is output from the speakers and then picked up by the microphone again, creating an echo.	Use the following methods to reduce the echo: Lower the volume on the receiver Have both parties pause slightly before speaking



# Appendix

Symptom	Cause	Action (Reference)
There's no picture.	The parking brake cord is not connected.	Connect the parking brake cord, and apply the parking brake.
	The parking brake is not applied.	Connect the parking brake cord, and apply the parking brake.
	The backlight of the LCD panel is turned off.	Turn on the backlight. (Page 188)
Rear display picture disappears.	The source disc being listened to in the navigation system has been ejected.	Before ejecting the disc, switch the source. This problem may occur when certain connection methods are used.
	There is a problem with the rear display, for example a faulty wiring connection.	Check the rear display and its connection.
	An AV source that cannot output to the rear display is selected.	Select an appropriate AV source.
Nothing is displayed and the touch panel keys cannot be used.	The setting for the rear view camera is incorrect.	Select the appropriate setting for the rear view camera.
	The shift lever was placed in [R] when the rear view camera was not connected.	Select the correct polarity setting for "Back Camera". (Page 174)
There is no response when the touch panel keys are touched, or a different key responds.	The touch panel keys deviate from the actual positions that respond to your touch for some reason.	Perform touch panel calibration. (Page 174)
The external storage device (USB, SD) cannot be used.	The USB storage device has been removed immediately after plugging it.	Park your vehicle in a safe place, and turn off the engine. Turn the ignition key back to off (ACC OFF). Then start the engine again, and turn the power to the navigation system back on.

## Problems in the AV screen

Symptom	Cause	Action (Reference)
CD or DVD playback is not possible.	The disc is inserted upside down.	Insert the disc with the label upward.
	The disc is dirty.	Clean the disc.
	The disc is cracked or otherwise damaged.	Insert a normal, round disc.
	The files on the disc are an irregular file format.	Check the file format.
	The disc format cannot be played back.	Replace the disc.
	The loaded disc is a type this system cannot play.	Check what type of disc it is. (Page 214)
The screen is covered by a caution message and the video cannot be shown.	The parking brake lead is not connected or applied.	Connect the parking brake lead correctly, and apply the parking brake.
	The parking brake interlock is activated.	Park your vehicle in a safe place and apply the parking brake.

# Appendix

Symptom	Cause	Action (Reference)
No video output from connected equipment.	"AV1 Input" or "AV2 Input" setting is incorrect.	Correct the settings. (Page 154)
No video output from connected iPod.	The connection of the USB interface cable for iPod is incorrect.	Connect both the USB plug and the RCA cable side. (If only one of these connection has been made, the iPod will not work properly.) (Page 22)
The audio or video skips.	The navigation system is not firmly secured.	Secure the navigation system firmly.
No sounds are produced.	Cables are not connected correctly.	Connect the cables correctly.
The volume level will not rise.	The system is performing still, slow motion, or frame by frame playback with DVD Video.	There is no sound during still, slow motion, or frame by frame playback with DVD Video.
	The system is paused or performing, fast reverse or forward during the disc playback.	For the media other than music CD (CD DA), there is no sound on fast reverse or forward.
The icon  is displayed, and operation is not possible.	The operation is not compatible with the video configuration.	This operation is not possible. (For example, the DVD playing does not feature that angle, audio system, subtitle language, etc.)
The picture stops (pauses) and the navigation system cannot be operated.	The reading of data is impossible during disc playback.	Stop playback once, and start playback again.
The picture is stretched, with in correct aspect ratio.	The aspect setting is incorrect for the display.	Select the appropriate setting for that image. (Page 178, Page 110)
A parental lock message is displayed and DVD playback is not possible.	Parental lock is on.	Turn parental lock off or change the level. (Page 110)
Parental lock for DVD playback cannot be canceled.	The code number is incorrect.	Input the correct code number. (Page 110)
Playback is not with the audio language and subtitle language settings selected in "DVD/DivX® Setup".	The DVD playing does not feature dialog or subtitles in the language selected in "DVD/DivX® Setup".	Switching to a selected language is not possible if the language selected in "DVD/DivX® Setup" is not recorded on the disc. (Page 109)
The picture is extremely unclear/distorted and dark during playback.	The disc features a signal to prohibit copying. (Some discs may have this.)	Since the navigation system is compatible with the copy guard analog copy protect system, the picture may suffer from horizontal stripes or other imperfections when a disc with that kind of protection signal is viewed on some displays. This does not mean the navigation system is malfunctioning.
iPod cannot be operated.	The iPod is frozen.	<ul style="list-style-type: none"> <li>• Reconnect the iPod with the USB interface cable for iPod.</li> <li>• Update the iPod software version.</li> </ul>
	An error has occurred.	<ul style="list-style-type: none"> <li>• Reconnect the iPod with the USB interface cable for iPod.</li> <li>• Park your vehicle in a safe place, and turn off the engine. Turn the ignition key back to off (ACC OFF). Then start the engine again, and turn the power to the navigation system back on.</li> <li>• Update the iPod software version.</li> </ul>

# Appendix

## Problems with the phone screen

Symptom	Cause	Action (Reference)
Dialing is not possible because the touch panel keys for dialing are inactive.	Your phone is out of range for service.	Retry after re entering the range for service.
	The connection between the cellular phone and the navigation system cannot be established now.	Perform the connection process.

### If the screen becomes frozen...

Park your vehicle in a safe place, and turn off the engine. Turn the ignition key back to off (ACC OFF). Then start the engine again, and turn the power to the navigation system back on.



# Appendix

## Messages for navigation functions

The following messages may be displayed by your navigation system. Refer to the table below to identify the problem, then take the suggested corrective action.

There are occasions when you may see error messages other than those shown here. In such a case, follow the instructions given on the display.

Message	Cause	Action (Reference)
<b>Route calculation was not possible.</b>	Route calculation has failed because of a malfunction in map data, software, or hardware.	<ul style="list-style-type: none"> <li>• Change the destination.</li> <li>• Consult the Pioneer Local dealer if this message persists.</li> </ul>
<b>Route calculation not possible: destination is too far.</b>	The destination is too far.	Set a destination closer to the starting point.
<b>Route calculation not possible: destination is too close.</b>	The destination is too close.	Set a destination farther from the starting point.
<b>Route calculation not possible: navigation cannot be provided around destination or starting point.</b>	The destination, waypoint(s), or starting point are in an area where no road exists (e.g. a mountain) and the route calculation is impossible.	<ul style="list-style-type: none"> <li>• Set a destination and waypoint(s) on roads.</li> <li>• Reset the destination after you drive the vehicle to any road.</li> </ul>
<b>Route to destination cannot be calculated.</b>	The destination or waypoint(s) are in an isolated island, etc. without a ferry and the route calculation is impossible. If there is no road connected to your starting point or destination, this message will appear.	Change the destination.
<b>Failed to make the route profile.</b>	In rare cases, a route calculation error may occur.	<ul style="list-style-type: none"> <li>• Retry.</li> <li>• Consult the Pioneer Local dealer if this message persists.</li> </ul>
<b>No picture folder. Save jpeg file to /Pictures/ folder</b>	Cannot load the image because "Pictures" folder is not found in the inserted external storage device.	Use appropriate data and store it correctly. (Page 173)
	"Pictures" folder exists on the SD memory card but there is no loadable data in the folder.	Use appropriate data and store it correctly. (Page 173)
<b>Data Read error.</b>	Failed to read the data for some reason.	Use appropriate data and store it correctly. (Page 173)
<b>The file is corrupt</b>	The data is damaged or an attempt was made to set an image file that was not made to specifications as the splash screen.	Use appropriate data and store it correctly. (Page 173)

# Appendix

Message	Cause	Action (Reference)
<b>Connection failed.</b>	The cellular phone's Bluetooth wireless technology is turned off.	Activate the target phone's Bluetooth wireless technology.
	The cellular phone is paired (connected) with another device.	Cancel the pairing (connection) and retry.
	Rejection has been received from the cellular phone.	Operate the target phone and accept the connection request from the navigation system. (Furthermore, check the connection settings on your cellular phone.)
	The target cellular phone cannot be found.	Check whether your cellular phone is activated and, whether the distance to your cellular phone is not too far.
<b>Could not find any available phone.</b>	No available phone exists in the surroundings when the system searches for connectable cellular phones featuring Bluetooth wireless technology.	<ul style="list-style-type: none"> <li>• Activate the target phone's Bluetooth wireless technology.</li> <li>• Check whether your cellular phone is activated and, whether the distance to your cellular phone is not too far.</li> </ul>
<b>Registration failed.</b>	The cellular phone's Bluetooth wireless technology is turned off during the registration step.	Keep turning the target phone's Bluetooth wireless technology on during the registration.
	Rejection by the cellular phone has received.	Operate the target phone and accept the registration request from the navigation system. (Furthermore, check the connection settings on your cellular phone.)
	Registration step has failed for some reason.	Retry the registration and if the registration still fails, try registering using your cellular phone.



# Appendix

## Messages for audio functions

When problems occur with AV source playback, an error message appears on the display. Refer to the table below to identify the problem, then take the suggested corrective action. If the error persists, record the error message and contact your dealer or your nearest Pioneer service center. The messages in “( )” will appear on the rear display.

### Built-in DVD drive

Message	Cause	Action (Reference)
<b>Reading error (ERROR-02-XX)</b>	Dirty	Clean the disc.
	Scratched disc	Replace the disc.
	The disc is loaded upside down.	Check that the disc is loaded correctly.
<b>Playback error. Please remove the disc.</b>	There is an electrical or mechanical error.	<ul style="list-style-type: none"> <li>• Replace the disc.</li> <li>• Set the ACC to off and then set it to on again.</li> </ul>
<b>Region code cannot be matched (DIFFERENT REGION DISC)</b>	The disc does not have the same region number as the navigation system.	Replace the DVD Video with one bearing the correct region number.
<b>Unreadable disc (UNPLAYABLE DISC)</b>	This type of disc cannot be played by the navigation system.	Replace the disc with one the navigation system can play. (Page 217, Page 234)
<b>Playback error due to irregular temperature. Please remove the disc. (THERMAL PROTECTION IN MOTION)</b>	The temperature of the navigation system is out of the normal operating range.	Wait until the unit's temperature returns to within normal operating limits.
<b>Tracks that cannot be played back will be skipped (FILE SKIPPED)</b>	Files that are protected by digital rights management (DRM).	The protected files are skipped.
<b>Cannot play back all tracks (PROTECTED DISC)</b>	All the files on the inserted disc are secured by DRM.	Replace the disc.
<b>Flash write error. Unable to write to flash memory. (CAN NOT SAVE DATA)</b>	The playback history for VOD contents cannot be saved for some reason.	<ul style="list-style-type: none"> <li>• Retry.</li> <li>• If the message appears frequently, consult your dealer.</li> </ul>
<b>Your device is not authorized to play this protected DivX video. (YOUR DEVICE IS NOT AUTHORIZED TO PLAY THIS DivX PROTECTED VIDEO)</b>	The device does not match the device registered with the VOD provider. VOD content cannot be played back.	Check whether this device has been registered with the VOD provider.
<b>Video resolution not supported. (VIDEO RESOLUTION NOT SUPPORTED)</b>	High definition (HD) DivX video cannot be played.	Create playable one and retry.

### SD/USB/iPod

Message	Cause	Action (Reference)
<b>Tracks that cannot be played back will be skipped</b>	Files that are protected by digital rights management (DRM).	The protected files are skipped.
	This type of file cannot be played by this unit.	Replace it with the playable file. (Page 217, Page 234)

# Appendix

Message	Cause	Action (Reference)
<b>Cannot play back all tracks</b>	All the files on the inserted external storage device are secured by DRM.	Store playable files.
	All of the files cannot be played by this unit.	Replace it with the playable file. (Page 217, Page 234)
<b>USB flash drive was disconnected for device protection. Do not connect this USB flash drive to the unit. To restart USB, restart the unit.</b>	The USB connector or USB cable is short circuited.	Confirm that the USB connector or USB cable is not caught in something or damaged.
	The connected USB storage device consumes more than maximum allowable current.	Disconnect the USB storage device and do not use it. Turn the ignition switch to off, then back ACC to on or turn the ignition switch on and then connect the compliant USB storage device.
	The USB interface cable for iPod is short circuited.	Confirm that USB interface cable for iPod or USB cable is not caught in something or damaged.
<b>Authorization failure. iPod is not connected.</b>	The iPod is not compatible with this navigation system.	Use an iPod of a compatible version.
	Communication failure	<ul style="list-style-type: none"> <li>• Disconnect the cable from iPod. Once iPod main menu is displayed, connect the cable again.</li> <li>• If the message appears frequently, consult your dealer.</li> </ul>



## Appendix

### Positioning technology

#### Positioning by GPS

The Global Positioning System (GPS) uses a network of satellites orbiting the Earth. Each of the satellites, which orbit at a height of 68 900 000 feet (21 000 km), continually broadcast radio signals giving time and position information. This ensures that signals from at least three can be picked up from any open area on the ground's surface.

The accuracy of the GPS information depends on how good the reception is. When the signals are strong and reception is good, GPS can determine latitude, longitude and altitude for accurate positioning in three dimensions. But if signal quality is poor, only two dimensions, latitude and longitude, can be obtained and positioning errors are somewhat greater.

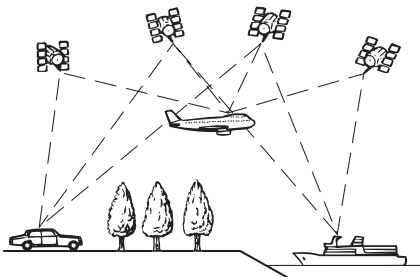

#### Positioning by dead reckoning

The built in sensor in the navigation system also calculates your position. The current location is measured by detecting driving distance with the speed pulse, the turning direction with the gyro sensor and inclination of the road with the G sensor.

The built in sensor can even calculate changes of altitude, and correct the discrepancies in the distance traveled caused by driving along winding roads or up slopes.

If you use this navigation system with connecting the speed pulse, the system will become more accurate than no connection of speed

pulse. So you connect the speed pulse without fail to get the accuracy of positioning.

- ❑ The position of the speed detection circuit vary depending on the vehicle model. For details, consult your authorized Pioneer dealer or an installation professional.
- ❑ Some types of vehicles may not output a speed signal while driving at just a few kilometers per hour. In such a case, the current location of your vehicle may not be displayed correctly while in traffic congestion or in a parking lot.

#### How do GPS and dead reckoning work together?

For maximum accuracy, your navigation system continually compares GPS data with your estimated position as calculated from the data of built in sensor. However, if only the data from the built in sensor is available for a long period, positioning errors are gradually compounded until the estimated position becomes unreliable. For this reason, whenever GPS signals are available, they are matched with the data of the built in sensor and used to correct it for improved accuracy.

- ❑ If you use chains on your wheels for winter driving or put on the spare wheel, errors may suddenly increase because of difference in wheel diameter. Initialize the sensor status and it may recover the accuracy to normal condition.
  - ➔ For details, refer to *Clearing status* on page 158.



## Appendix

### Map matching

As mentioned, the positioning systems used by this navigation system are susceptible to certain errors. Their calculations may, on occasion, place you in a location on the map where no road exists. In this situation, the processing system understands that vehicles travel only on roads, and can correct your position by adjusting it to a nearby road. This is called map matching.

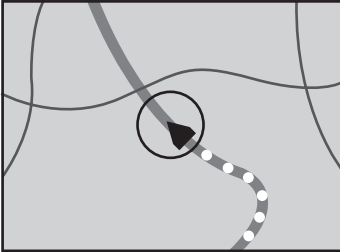

With map matching

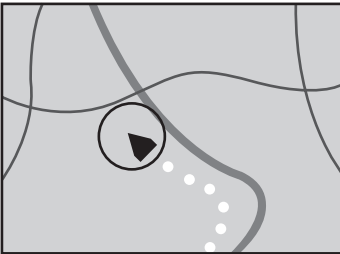

Without map matching



### Handling large errors

Positioning errors are kept to a minimum by combining GPS, dead reckoning and map matching. However, in some situations, these functions may not work properly, and the error may become bigger.

### When positioning by GPS is impossible

- GPS positioning is disabled if signals can not be received from more than two GPS satellites.
- In some driving conditions, signals from GPS satellites may not reach your vehicle. In this case, it is impossible for the system to use GPS positioning.



In tunnels or enclosed parking garages

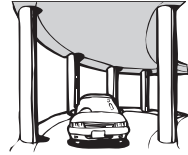

Under elevated roads or similar structures



When driving among high buildings



When driving through a dense forest or tall trees

- If a car phone or cellular phone is used near the GPS antenna, GPS reception may be lost temporarily.
- Do not cover the GPS antenna with spray paint or car wax, because this may block the reception of GPS signals. Snow buildup can also degrade the signals, so keep the antenna clear.
- ❑ If a GPS signal has not been received for a long time, your vehicle's actual position and the current position mark on the map may diverge considerably or may not be up dated. In such case, once GPS reception is restored, accuracy will be recovered.

## Appendix

### Conditions likely to cause noticeable positioning errors

For various reasons, such as the state of the road you are traveling on and the reception status of the GPS signal, the actual position of your vehicle may differ from the position displayed on the map screen.

- If you make a slight turn.

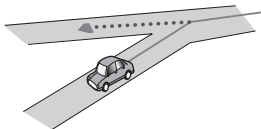

- If there is a parallel road.

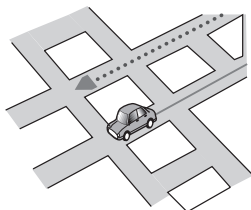

- If there is another road very nearby, such as in the case of an elevated freeway.

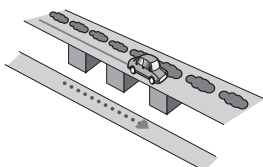

- If you take a recently opened road that is not on the map.

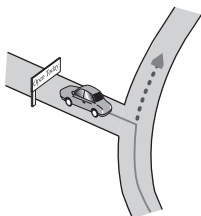

- If you drive in zigzags.

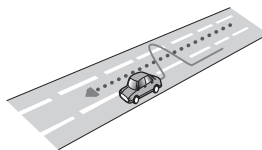

- If the road has a series of hairpin bends.

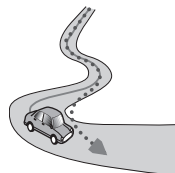

- If there is a loop or similar road configuration.

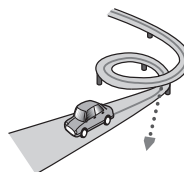

- If you take a ferry.

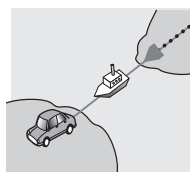

- If you are driving on a long, straight road or a gently curving road.

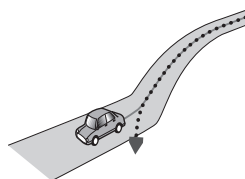

## Appendix

- If you are on a steep mountain road with many height changes.

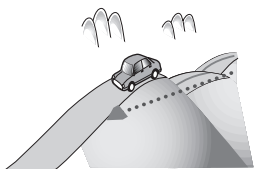

- If you enter or exit a multi storey parking lot or similar structure using a spiral ramp.

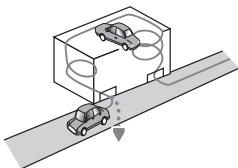

- If your vehicle is turned on a turntable or similar structure.

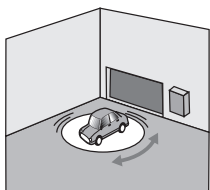

- If your vehicle's wheels spin, such as on a gravel road or in snow.



- If you put on chains, or change your tires for ones with a different size.

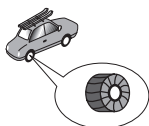

- If trees or other obstacles block the GPS signals for a considerable period.

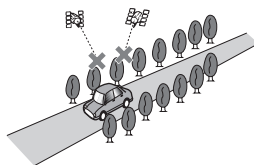

- If you drive very slowly, or in a start and stop manner, as in a traffic congestion.

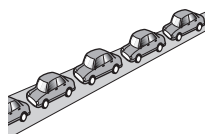

- If you join the road after driving around a large parking lot.

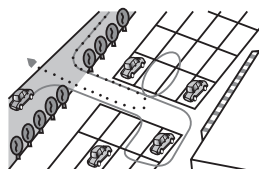

- When you drive around a traffic circle.

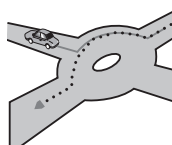

- When starting driving immediately after starting the engine.

# Appendix

## Route setting information

### Route search specifications

Your navigation system sets a route to your destination by applying certain built in rules to the map data. This section provides some useful information about how a route is set.



#### CAUTION

When a route is calculated, the route and voice guidance for the route are automatically set. Also, for day or time traffic regulations, only information about traffic regulations applicable at the time when the route was calculated is considered. One way streets and street closures may not be taken into consideration. For example, if a street is open during the morning only, but you arrive later, it would be against the traffic regulations so you cannot drive along the set route. When driving, please follow the actual traffic signs. Also, the system may not know some traffic regulations.

- The calculated route is one example of the route to your destination decided by the navigation system while taking the type of streets or traffic regulations into account. It is not necessarily an optimum route. (In some cases, you may not be able to set the streets you want to take. If you need to take a certain street, set a waypoint on that street.)
- If the destination is too far, there may be instances where the route cannot be set. (If you want to set a long distance route going across several areas, set waypoints along the way.)
- During voice guidance, turns and intersections from the freeway are announced. However, if you pass intersections, turns, and other guidance points in rapid succession, some may delay or not be announced.
- It is possible that guidance may direct you off a freeway and then back on again.
- In some cases, the route may require you to travel in the opposite direction to your

current heading. In such cases, you are instructed to turn around, so please turn around safely by following the actual traffic rules.

- In some cases, a route may begin on the opposite side of a railway or river from your actual current location. If this happens, drive towards your destination for a while, and try route calculation again.
- When there is a traffic congestion ahead, a detour route may not be suggested if driving through the traffic congestion would still be better than taking the detour.
- There may be instances when the starting point, the waypoint and the destination point are not on the highlighted route.
- The number of traffic circle exits displayed on the screen may differ from the actual number of roads.

### Route highlighting

- Once set, the route is highlighted in bright color on the map.
- The immediate vicinity of your starting point and destination may not be highlighted, and neither will areas with particularly complex road layouts. Consequently, the route may appear to be cut off on the display, but voice guidance will continue.

### Auto reroute function

- If you deviate from the set route, the system will recalculate the route from that point so that you remain on track to the destination.
- This function may not work under certain conditions. 

## Handling and care of discs

Some basic precautions are necessary when handling your discs.

## Appendix

### Built-in drive and care

- Use only conventional, fully circular discs. Do not use shaped discs.



- Do not use cracked, chipped, warped, or otherwise damaged discs as they may damage the built-in drive.
- When using discs that can be printed on label surfaces, check the instructions and the warnings of the discs. Depending on the discs, inserting and ejecting may not be possible. Using such discs may result in damage to this equipment.
- Do not touch the recorded surface of the discs.
- Store discs in their cases when not in use.
- Avoid leaving discs in excessively hot environments including under direct sunlight.
- Do not attach labels, write on or apply chemicals to the surface of the discs.
- Do not attach commercially available labels or other materials to the discs.

The discs may warp making the disc unplayable.

The labels may come off during playback and prevent ejection of the discs, which may result in damage to the equipment.

- To clean a disc, wipe it with a soft cloth, moving outward from the center.



- Condensation may temporarily impair the built-in drive's performance. Leave it to adjust to the warmer temperature for about one hour. Also, wipe any damp discs with a soft cloth.

- Playback of discs may not be possible because of disc characteristics, disc format, recorded application, playback environment, storage conditions and so on.
- Road shocks may interrupt disc playback.
- Read the precautions for discs before using them.

### Ambient conditions for playing a disc

- At extremely high temperatures, a temperature cutout protects this product by switching it off automatically.
- Despite our careful design of the product, small scratches that do not affect actual operation may appear on the disc surface as a result of mechanical wear, ambient conditions for use or handling of the disc. This is not a sign of the malfunction of this product. Consider it to be normal wear and tear. ■

### Playable discs

#### DVD-Video and CD

DVD and CD discs that display the logos shown below generally can be played on this built-in DVD drive.

#### DVD-Video



#### CD



## Appendix

- ❑ **DVD** is a trademark of DVD Format/Logo Licensing Corporation.
- ❑ It is not possible to play DVD Audio discs. This DVD drive may not be able to play all discs bearing the marks shown above.



### AVCHD recorded discs

This unit is not compatible with discs recorded in AVCHD (Advanced Video Codec High Definition) format. Do not insert AVCHD discs. If inserted, the disc may not be ejected.

### Playing DualDisc

- DualDiscs are two sided discs that have a recordable CD for audio on one side and a recordable DVD for video on the other.
- Playback of the DVD side is possible with this navigation system. However, since the CD side of DualDiscs is not physically compatible with the general CD standard, it may not be possible to play the CD side with this navigation system.
- Frequent loading and ejecting of a DualDisc may result in scratches to the disc.
- Serious scratches can lead to playback problems on this navigation system. In some cases, a DualDisc may become stuck in the disc loading slot and will not eject. To prevent this, we recommend you refrain from using DualDisc with this navigation system.
- Please refer to the manufacturer for more detailed information about DualDiscs.

### Dolby Digital

This product will down mix Dolby Digital signals internally and the sound will be output in stereo.

- ❑ Manufactured under license from Dolby Laboratories. "Dolby" and the double D symbol are trademarks of Dolby Laboratories.

## Detailed information for playable media

### Compatibility

#### Common notes about disc compatibility

- Certain functions of this product may not be available for some discs.
- Compatibility with all discs is not guaranteed.
- It is not possible to playback DVD ROM/ DVD RAM discs.
- Playback of discs may become impossible with direct exposure to sunlight, high temperatures, or depending on the storage conditions in the vehicle.

#### DVD-Video discs

- DVD Video discs that have incompatible region numbers cannot be played on this DVD drive. The region number of the player can be found on this product's chassis.

#### DVD-R/DVD-RW/DVD-R DL (Dual Layer) discs

- Unfinalized discs which have been recorded with the Video format (video mode) cannot be played back.
- Discs which have been recorded with the Video Recording format (VR mode) cannot be played back.
- DVD R DL (Dual Layer) discs which have been recorded with Layer Jump recording cannot be played back.
- For detailed information about recording mode, please contact the manufacturer of media, recorders, or writing software.

# Appendix

## CD-R/CD-RW discs

- Unfinalized discs cannot be played back.
- It may not be possible to playback CD R/CD RW discs recorded on a music CD recorder or a personal computer because of disc characteristics, scratches or dirt on the disc, or dirt, scratches or condensation on the lens of the built in drive.
- Playback of discs recorded on a personal computer may not be possible, depending on the recording device, writing software, their settings, and other environmental factors.
- Please record with the correct format. (For details, please contact manufacturer of media, recorders, or writing software.)
- Titles and other text information recorded on a CD R/CD RW disc may not be displayed by this product (in the case of audio data (CD DA)).
- Read the precautions with CD R/CD RW discs before using them.

## Common notes about the external storage device (USB, SD)

- Do not leave the external storage device (USB, SD) in any location with high temperatures.
- Depending on the kind of the external storage device (USB, SD) you use, this navigation system may not recognize the storage device or files may not be played back properly.
- The text information of some audio and video files may not be correctly displayed.
- File extensions must be used properly.
- There may be a slight delay when starting playback of files on an external storage device (USB, SD) with complex folder hierarchies.
- Operations may vary depending on the kind of an external storage device (USB, SD).
- It may not be possible to play some music files from SD or USB because of file characteristics, file format, recorded applica-

tion, playback environment, storage conditions, and so on.

## USB storage device compatibility

- ➔ For details about USB storage device compatibility with this navigation system, refer to *Specifications* on page 234.
- Protocol: bulk
- You cannot connect a USB storage device to this navigation system via a USB hub.
- Partitioned USB storage device is not compatible with this navigation system.
- Firmly secure the USB storage device when driving. Do not let the USB storage device fall onto the floor, where it may become jammed under the brake or gas pedal.
- There may be a slight delay when starting playback of audio files encoded with image data.
- Some USB storage devices connected to this navigation system may generate noise on the radio.
- Do not connect anything other than the USB storage device.

## The sequence of audio files on USB storage device

For USB storage device, the sequence is different from that of USB storage device.

## SD memory card and SDHC memory card

- ➔ For details about SD memory card compatibility with this navigation system, refer to *Specifications* on page 234.

## Handling guidelines and supplemental information

- This system is not compatible with Multi Media Card (MMC).
- Copyright protected files cannot be played back.

## Appendix

### Notes specific to DivX files

- Only DivX files downloaded from DivX partner sites are guaranteed for proper operation. Unauthorized DivX files may not operate properly.
- DRM rental files cannot be operated until playing back is started.
- The navigation system corresponds to a DivX file display of up to 1 590 minutes 43 seconds. Search operations beyond this time limit are prohibited.
- DivX VOD file playback requires supplying the ID code of this navigation system to the DivX VOD provider. Regarding the ID code, refer to *Displaying your DivX VOD registration code* on page 181.
- Plays all versions of DivX video, except for DivX 7 with standard playback of DivX media files.
- For more details about DivX, visit the following site:  
<http://www.divx.com/>

### DivX subtitle files

- Srt format subtitle files with the extension “.srt” can be used.
- Only one subtitle file can be used for each DivX file. Multiple subtitle files cannot be associated.
- Subtitle files that are named with the same character string as the DivX file before the extension are associated with the DivX file. The character strings before the extension must be exactly the same. However, if there is only one DivX file and one subtitle file in a single folder, the files are associated even if the file names are not the same.
- The subtitle file must be stored in the same folder as the DivX file.
- Up to 255 subtitle files may be used. Any more subtitle files will not be recognized.
- Up to 64 characters can be used for the name of the subtitle file, including the extension. If more than 64 characters are used for the file name, the subtitle file may not be recognized.
- The character code for the subtitle file should comply with ISO 8859 1. Using characters other than ISO 8859 1 may cause the characters to be displayed incorrectly.
- The subtitles may not be displayed correctly if the displayed characters in the subtitle file include control code.
- For materials that use a high transfer rate, the subtitles and video may not be completely synchronized.
- If multiple subtitles are programmed to display within a very short time frame, such as 0.1 seconds, the subtitles may not be displayed at the correct time.



# Appendix

## Media compatibility chart

### General

Media	CD-R/-RW	DVD-R/-RW/-R DL	USB storage de- vice	SD memory card
File system	ISO9660 level 1, ISO9660 level 2, Romeo and Joliet	ISO9660 level 1, ISO9660 level 2, Romeo, Joliet and UDF 1.02	FAT16/FAT32	
Maximum number of folders	700		300	
Maximum number of files	999	3 500	2 500	
Playable file types	MP3, WMA, AAC, DivX		MP3, WMA, AAC, WAVE, H.264, MPEG4, WMV	
<b>Note:</b>	Maximum playback time of audio file stored in the external storage device (USB, SD): 7.5 h (450 minutes)			

### MP3 compatibility

Media	CD-R/-RW	DVD-R/-RW/-R DL	USB storage de- vice	SD memory card
File extension	.mp3			
Bit rate	8 kbps to 320 kbps (CBR), VBR			
Sampling frequency	16 kHz to 48 kHz (32 kHz, 44.1 kHz, 48 kHz for emphasis)		8 kHz to 48 kHz	
ID3 tag	ID3 tag Ver. 1.0, 1.1, 2.2, 2.3		ID3 tag Ver. 1.0, 1.1, 2.2, 2.3, 2.4	
<b>Notes:</b>	<ul style="list-style-type: none"> <li>Ver. 2.x of ID3 tag is given priority when both Ver. 1.x and Ver. 2.x exist.</li> <li>The navigation system is not compatible with the following: MP3i (MP3 interactive), mp3 PRO, m3u playlist</li> </ul>			

# Appendix

## WMA compatibility

Media	CD-R/-RW	DVD-R/-RW/-R DL	USB storage de- vice	SD memory card
File extension	.wma			
Bit rate	5 kbps to 320 kbps (CBR), VBR			
Sampling frequency	8 kHz to 48 kHz			
<b>Note:</b> The navigation system is not compatible with the following: Windows Media™ Audio 9 Professional, Lossless, Voice				

## WAV compatibility

Media	CD-R/-RW	DVD-R/-RW/-R DL	USB storage de- vice	SD memory card
File extension	WAV files on the CD R/ RW, DVD R/ RW/ R DL cannot be played.		.wav	
Format			Linear PCM (LPCM), IMA ADPCM	
Sampling frequency			LPCM: 16 kHz to 48 kHz IMA ADPCM: 22.05 kHz and 44.1 kHz	
Quantization bits			LPCM: 8 bits and 16 bits MS ADPCM: 4 bits	
<b>Note:</b> The sampling frequency shown in the display may be rounded.				

## AAC compatibility

Media	CD-R/-RW	DVD-R/-RW/-R DL	USB storage de- vice	SD memory card
File extension	.m4a			
Bit rate	8 kbps to 320 kbps (CBR)			
Sampling frequency	8 kHz to 44.1 kHz		8 kHz to 48 kHz	
<b>Note:</b> The navigation system plays back AAC files encoded by iTunes.				

# Appendix

## DivX compatibility

Media	CD-R/-RW	DVD-R/-RW/-R DL	USB storage device	SD memory card
File extension	.avi/.divx		DivX files on the external storage device (USB, SD) cannot be played.	
Profile (DivX version)	Home Theater Ver. 3.11/Ver. 4.x/Ver. 5.x/Ver. 6.x			
Compatible audio codec	MP3, Dolby Digital			
Bit rate (MP3)	8 kbps to 320 kbps (CBR), VBR			
Sampling frequency (MP3)	16 kHz to 48 kHz (32 kHz, 44.1 kHz, 48 kHz for emphasis)			
Maximum image size	720 pixels × 576 pixels			
Maximum file size	4 GB			
<b>Notes:</b>				
<ul style="list-style-type: none"> <li>The navigation system is not compatible with the following: DivX Ultra format, DivX files without video data, DivX files encoded with LPCM (Linear PCM) audio codec</li> <li>Depending on the file information composition, such as the number of audio streams, there may be a slight delay in the start of playback on discs.</li> <li>If a file contains more than 4 GB, playback stops before the end.</li> <li>Some special operations may be prohibited because of the composition of DivX files.</li> <li>Files with high transfer rates may not be played back correctly. The standard transfer rate is 4 Mbps for CDs and 10.08 Mbps for DVDs.</li> </ul>				

# Appendix

## Video files compatibility (USB, SD)

File extension		.avi	.mp4, .m4v		.wmv
Format		MPEG 4	MPEG 4	H.264	WMV
Compatible video codec		MPEG 4	MPEG 4	H.264	WMV
Compatible audio codec		Linear PCM (LPCM), IMA ADPCM MP3	AAC	AAC	WMA
Recommended video specifications	Image size: QVGA (320 pixels x 240 pixels)	Bit rate: 768 kbps Frame rate: 30 fps	Bit rate: 768 kbps Frame rate: 30 fps	Bit rate: 384 kbps Frame rate: 30 fps	Bit rate: 384 kbps Frame rate: 30 fps
Maximum bit rate:	Image size: WQVGA (400 pixels x 240 pixels)	Bit rate: 2 Mbps Frame rate: 30 fps	Bit rate: 2 Mbps Frame rate: 30 fps	Bit rate: 1 Mbps Frame rate: 30 fps	Bit rate: 768 kbps Frame rate: 30 fps
	Image size: VGA (640 pixels x 480 pixels)	Bit rate: 1 Mbps Frame rate: 30 fps	Bit rate: 1 Mbps Frame rate: 30 fps	Bit rate: 576 kbps Frame rate: 30 fps	Bit rate: 576 kbps Frame rate: 30 fps
Maximum file size		2 GB			
Maximum playback time		150 minutes			

### Common notes

- The navigation system may not operate correctly, depending on the application used to encode WMA files.
- Depending on the version of Windows Media™ Player used to encode WMA files, album names and other text information may not be correctly displayed.
- There may be a slight delay when starting playback of audio files encoded with image data.
- The navigation system is not compatible with packet write data transfer.
- This navigation system can recognize up to 32 characters, beginning with the first character, including extension for the file and folder name. Depending on the display area, the navigation system may try to display them with a reduced font size. However, the maximum number of the characters that you can display varies according to the width of each character, and of the display area.
- Folder selection sequence or other operations may be altered, depending on the encoding or writing software.
- Regardless of the length of blank section between the songs of original recording, compressed audio discs play with a short pause between songs.

## Appendix

### Example of a hierarchy

The following figure is an example of the tier structure in the disc. The numbers in the figure indicate the order in which folder numbers are assigned and the order to be played back.

 Folder

 File

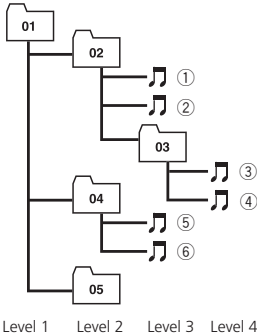

### Notes

- This product assigns folder numbers. The user cannot assign folder numbers.
- If there is a folder that does not contain any playable file, the folder itself will display in the folder list but you cannot check any files in the folder. (A blank list will appear.) Also, these folders will be skipped without displaying the folder number. 

## Bluetooth



Bluetooth is a short range wireless radio connectivity technology that is developed as a cable replacement for cellular phones, hand held PCs and other devices. Bluetooth operates in 2.4 GHz frequency range and transmits voice and data at speeds up to 1 megabit per second. Bluetooth was launched by a special

interest group (SIG) comprising Ericsson Inc., Intel Corp., Nokia Corp., Toshiba and IBM in 1998, and it is currently developed by nearly 2 000 companies worldwide.

- The *Bluetooth*<sup>®</sup> word mark and logos are registered trademarks owned by Bluetooth SIG, Inc. and any use of such marks by PIONEER CORPORATION is under license. Other trademarks and trade names are those of their respective owners. 

## About the SAT RADIO READY Logo

The SAT RADIO READY logo indicates that the Satellite Radio Tuner for Pioneer (i. e., XM tuner and Sirius satellite tuner which are sold separately) can be controlled by this navigation system. Please inquire with your dealer or nearest authorized Pioneer service station regarding the satellite radio tuner that can be connected to this navigation system.

### Note:

Everything worth listening to is on SiriusXM, getting over 130 channels, including the most commercial free music, plus the best sports, news, talk and entertainment. Sirius, XM, SAT Radio Ready and all related logos and marks are trademarks of Sirius XM Radio, Inc. All rights reserved. 

## HD Radio™ Technology

- AVIC Z140BH  
HD Radio Technology manufactured under license from iBiquity Digital Corporation. U.S. and Foreign Patents. HD Radio™ and the HD, HD Radio, and "Arc" logos are proprietary trademarks of iBiquity Digital Corp. 

## Appendix

### SD and SDHC logo



SD Logo is a trademark of SD 3C, LLC.



SDHC Logo is a trademark of SD 3C, LLC.



microSD Logo is a trademark of SD 3C, LLC.



microSDHC Logo is a trademark of SD 3C, LLC. □

### WMA/WMV

Windows Media is either a registered trademark or trademark of Microsoft Corporation in the United States and/or other countries.

- This product includes technology owned by Microsoft Corporation and cannot be used or distributed without a license from Microsoft Licensing, Inc. □

### DivX



DivX is a compressed digital video format created by the DivX video codec from DivX, LLC, a

subsidiary of Rovi Corporation. This unit can play DivX video files recorded on CD R/RW/ROM and DVD R/RW/ROM discs. Keeping the same terminology as DVD video, individual DivX video files are called "Titles". Keep in mind that when naming files/titles on a CD R/RW or a DVD R/RW disc prior to burning, they will be played in written order by default.

- DivX®, DivX Certified® and associated logos are trademarks of Rovi Corporation or its subsidiaries and are used under license.

**ABOUT DIVX VIDEO:** DivX® is a digital video format created by DivX, LLC, a subsidiary of Rovi Corporation. This is an official DivX Certified® device that plays DivX video. Visit [divx.com](http://divx.com) for more information and software tools to convert your files into DivX videos.

**ABOUT DIVX VIDEO-ON-DEMAND:** This DivX Certified® device must be registered in order to play purchased DivX Video on Demand (VOD) movies. To obtain your registration code, locate the DivX VOD section in *Displaying your DivX VOD registration code*. Go to [vod.divx.com](http://vod.divx.com) for more information on how to complete your registration.

- ➔ For details, refer to *Displaying your DivX VOD registration code* on page 181. □

### AAC

AAC is short for Advanced Audio Coding and refers to an audio compression technology standard used with MPEG 2 and MPEG 4. Several applications can be used to encode AAC files, but file formats and extensions differ depending on the application which is used to encode. This unit plays back AAC files encoded by iTunes. □

### Android™

Android is a trademark of Google Inc. □

## Appendix

### BlackBerry®

The Trademark BlackBerry® is owned by Research In Motion Limited and is registered in the United States and may be pending or registered in other countries. PIONEER CORPORATION is not endorsed, sponsored, affiliated with or otherwise authorized by Research In Motion Limited. 

### Detailed information regarding connected iPod devices

#### CAUTION

- Pioneer accepts no responsibility for data lost from an iPod, even if that data is lost while using the navigation system. Please back up your iPod data regularly.
- Do not leave the iPod in direct sunlight for extended amounts of time. Extended exposure to direct sunlight can result in iPod malfunction due to the resulting high temperature.
- Do not leave the iPod in any location with high temperatures.
- Firmly secure the iPod when driving. Do not let the iPod fall onto the floor, where it may become jammed under the brake or gas pedal.

For details, refer to the iPod manuals.

### iPod and iPhone



“Made for iPod” and “Made for iPhone” mean that an electronic accessory has been designed to connect specifically to iPod or iPhone, respectively, and has been certified by the developer to meet Apple performance standards.

Apple is not responsible for the operation of this device or its compliance with safety and regulatory standards.

Please note that the use of this accessory with iPod or iPhone may affect wireless performance.

iPhone, iPod, iPod classic, iPod nano, and iPod touch are trademarks of Apple Inc., registered in the U.S. and other countries.

### iTunes

iTunes is a trademark of Apple Inc., registered in the U.S. and other countries. 

### Using app-based connected content

#### IMPORTANT

Requirements to access app based connected content services such as Pandora internet radio and Aha Radio using the Pioneer navigation system:

- Latest version of the Pioneer compatible connected content application(s) for the smartphone, available from the service provider, downloaded to your smartphone.
- A current account with the content service provider.
- Smartphone Data Plan.  
**Note:** if the Data Plan for your smartphone does not provide for unlimited data usage, additional charges from your carrier may apply for accessing app based connected content via 3G and/or EDGE networks.
- Connection to the Internet via 3G, EDGE or Wi Fi network.
- Optional Pioneer adapter cable connecting your iPhone to the Pioneer navigation system.

#### Limitations:

- Access to app based connected content will depend on the availability of cellular and/or Wi Fi network coverage for the purpose of allowing your smartphone to connect to the Internet.

## Appendix

- Service availability may be geographically limited to the region. Consult the connected content service provider for additional information.
- Ability of this product to access connected content is subject to change without notice and could be affected by any of the following: compatibility issues with future firmware versions of smartphone; compatibility issues with future versions of the connected content application(s) for the smartphone; changes to or discontinuation of the connected Content application(s) or service by its provider.

### Pandora® internet

Pandora is a registered trademark of Pandora Media, Inc.

### Aha Radio

Aha, Aha Radio and the Aha and Aha Radio logos are either the trademarks or the registered trademarks of Harman International Industries, Incorporated. 

## Using the LCD screen correctly

### Handling the LCD screen

- When the LCD screen is subjected to direct sunlight for a long period of time, it will be come very hot, resulting in possible damage to the LCD screen. When not using this navigation system, avoid exposing it to direct sunlight as much as possible.
- The LCD screen should be used within the temperature ranges shown in *Specifications*.
- Do not use the LCD screen at temperatures higher or lower than the operating temperature range, because the LCD screen may not operate normally and could be damaged.
- The LCD screen is exposed in order to increase its visibility within the vehicle. Please do not press strongly on it as this may damage it.

- Do not push the LCD screen with excessive force as this may scratch it.
- Never touch the LCD screen with anything besides your finger when operating the touch panel functions. The LCD screen can scratch easily.

### Liquid crystal display (LCD) screen

- If the LCD screen is near the vent of an air conditioner, make sure that air from the air conditioner is not blowing on it. Heat from the heater may break the LCD screen, and cool air from the cooler may cause moisture to form inside the navigation unit, resulting in possible damage.
- Small black dots or white dots (bright dots) may appear on the LCD screen. These are due to the characteristics of the LCD screen and do not indicate a malfunction.
- The LCD screen will be difficult to see if it is exposed to direct sunlight.
- When using a cellular phone, keep the antenna of the cellular phone away from the LCD screen to prevent disruption of the video in the form of disturbances such as spots or colored stripes.

### Maintaining the LCD screen

- When removing dust from the LCD screen or cleaning it, first turn the system power off, then wipe with a soft dry cloth.
- When wiping the LCD screen, take care not to scratch the surface. Do not use harsh or abrasive chemical cleaners.



## Appendix

### LED (light-emitting diode) backlight

A light emitting diode is used inside the display to illuminate the LCD screen.

- At low temperatures, using the LED backlight may increase image lag and degrade the image quality because of the characteristics of the LCD screen. Image quality will improve with an increase in temperature.
- The product lifetime of the LED backlight is more than 10 000 hours. However, it may decrease if used in high temperatures.
- If the LED backlight reaches the end of its product lifetime, the screen will become dimmer and the image will no longer be visible. In that case, please consult your dealer or the nearest authorized Pioneer Service Station. 

# Appendix

## Display information

### Destination Menu

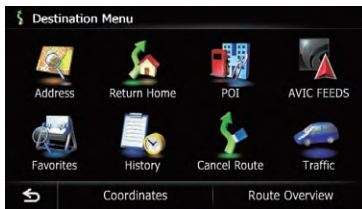

	Page
Address	38
Return Home	40
POI	
Gas Station	
Bank	41
Coffee	
Hotel	
Spell Name	41
Near Me	41
Near Destination	42
Around City	42
AVIC FEEDS	43
Favorites	43, 50
History	44, 53
Cancel Route	49
Traffic	54
Coordinates	44
Route Overview	46

### Phone Menu

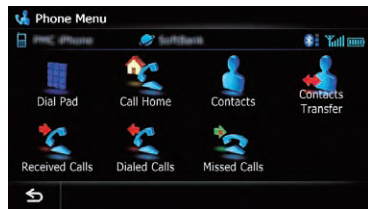

	Page
Dial Pad	64
Call Home	65
Contacts	65
Contacts Transfer	68
Received Calls	66
Dialed Calls	66
Missed Calls	66

# Appendix

## Settings Menu

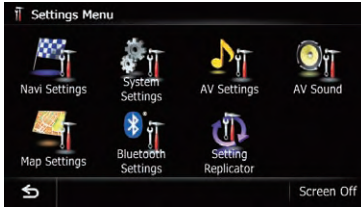

	Page
<b>Navi Settings</b>	157
<b>System Settings</b>	170
<b>AV Settings</b>	177
<b>AV Sound</b>	181
<b>Map Settings</b>	163
<b>Bluetooth Settings</b>	69
<b>Setting Replicator</b>	188

## Navi Settings menu

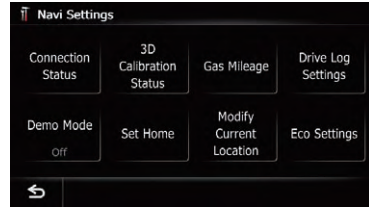

	Page
<b>Connection Status</b>	157
<b>3D Calibration Status</b>	158
<b>Gas Mileage</b>	159
<b>Drive Log Settings</b>	161
<b>Demo Mode</b>	161
<b>Set Home</b>	162
<b>Modify Current Location</b>	162
<b>Eco Settings</b>	162

# Appendix

## System Settings menu

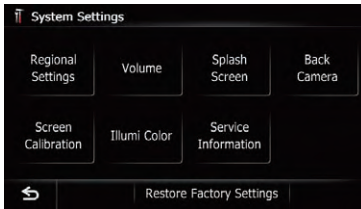

	Page
<b>Regional Settings</b>	
Program Language	171
Voice Language	171
Time	171
km / mile	171
Average Speed	172
Volume	172
Splash Screen	173
Back Camera	174
Screen Calibration	174
Illumi Color	175
Service Information	175
Restore Factory Settings	196

## Map Settings menu

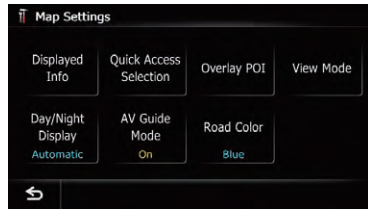

	Page
<b>Displayed Info</b>	
Close Up View	164
City Map	164
City Map Barrier	164
Show Traffic Incident	165
Bluetooth Connected	165
Current Street Name	165
Favorites Icon	166
3D Land Mark	166
Show Maneuver	166
Show Eco Meter	167
Quick Access Selection	169
Overlay POI	167
View Mode	34
Day/Night Display	168
AV Guide Mode	169
Road Color	169

# Appendix

## Bluetooth Settings menu

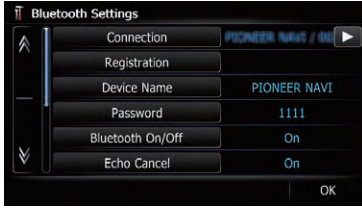

	Page
Connection	62
Registration	59
Device Name	69
Password	70
Bluetooth On/Off	70
Echo Cancel	70



	Page
Auto Answer Preference	70
Refuse All Calls	71
Sort Order	69
Clear Memory	71
Firmware update	72

## AV System Settings menu



	Page
AV1 Input	177
AV2 Input	178
Wide Mode	178
Auto EQ Meas.	184
App Connection	131
Mute	179
Mute Level	179
Rear SP	179
DivX® VOD	181
VR Catalog Menu	180

## AV Sound Settings menu



	Page
<b>FAD/BAL (Balance)</b>	182
<b>EQ</b>	182
<b>Loudness</b>	186
<b>Sub Woofer</b>	187
<b>HPF</b>	187
<b>SLA</b>	187
<b>Bass Booster</b>	188
<b>Sonic Center Control</b>	186



# Appendix

## Glossary

### AAC

AAC is short for Advanced Audio Coding and refers to an audio compression technology standard used with MPEG 2 and MPEG 4.

### Aspect ratio

This is the width to height ratio of a TV screen. A regular display has an aspect ratio of 4:3. Wide screen displays have an aspect ratio of 16:9, providing a bigger picture for exceptional presence and atmosphere.

### Bit rate

This expresses data volume per second, or bps units (bits per second). The higher the rate, the more information is available to reproduce the sound. Using the same encoding method (such as MP3), the higher the rate, the better the sound.

### Built-in sensor

The built in sensor that enables the system to estimate your vehicle's position.

### CD-DA

This stands for a general music CD (commercial release audio CD). In this manual, this word is sometime used for a distinction between data CDs (which include compressed audio files) and general music CDs.

### Chapter

Titles of DVD Video are in turn divided into chapters which are numbered in the same way as the chapters of a book. With discs featuring chapters, you can quickly find a desired scene with chapter search.

### Current location

The present location of your vehicle; your current location is shown on the map by a red triangle mark.

### Destination

A location you choose as the end point of your journey.

### DivX

DivX is a popular media technology created by DivX, LLC, a subsidiary of Rovi Corporation. DivX media files contain highly compressed video with high visual quality that maintains a relatively small file size. DivX files can also include advanced media features like menus, subtitles, and alternate audio tracks. Many DivX media files are available for download online, and you can create your own using your personal content and easy to use tools from DivX.com.

### DivX Certified®

DivX Certified® products are officially tested by the creators of DivX and guaranteed to play all versions of DivX video, except for DivX 7.

### Favorites

A frequently visited location (such as your workplace or a relative's home) that you can register to allow easy routing.

### GPS

Global Positioning System. A network of satellites that provides navigation signals for a variety of purposes.

### Guidance point

These are important landmarks along your route, generally intersections. The next guidance point along your route is indicated on the map by the yellow flag icon.

### Home location

Your registered home location.

### ID3 tag

This is a method of embedding track related information in an MP3 file. This embedded information can include the track title, the artist's name, the album title, the music genre, the year of production, comments and other data. The contents can be freely edited using software with ID3 tag editing functions. Although the tags are restricted by the number of characters, the information can be viewed when the track is played back.

# Appendix

## ISO 9660 format

This is the international standard for the format logic of DVD/CD ROM folders and files. For the ISO9660 format, there are regulations for the following two levels:

- **Level 1:**  
The file name is in 8.3 format (the name consists of up to eight characters, half byte English capital letters, half byte numerals and the “ ” sign, with a file extension of three characters).
- **Level 2:**  
The file name can have up to 31 characters (including the separation mark “.” and a file extension). Each folder contains less than eight hierarchies.
- **Extended formats**  
Joliet:  
File names can have up to 64 characters.  
Romeo:  
File names can have up to 128 characters.

## JPEG

This stands for Joint Photographic Experts Group, and is an international still image compression standard.

## MP3

MP3 is short for MPEG Audio Layer 3. It is an audio compression standard established by a working group (MPEG) of the ISO (International Organization for Standardization). MP3 is able to compress audio data to about 1/10th the size of a conventional disc.

## MPEG

This stands for Moving Pictures Experts Group, and is an international video image compression standard.

## Multi-angle

With regular TV programs, although multiple cameras are used to simultaneously shoot scenes, only images from one camera at a time are transmitted to your TV. Some DVDs feature scenes shot from multiple angles, letting you choose your viewing angle as desired.

## Multi-audio (Multilingual dialog)

Some videos feature dialog recorded in multiple languages or audio recorded in multiple tracks. For example, dialog in up to eight languages can be recorded on a single DVD Video, letting you choose the language as desired.

## Multi-session

Multi session is a recording method that allows additional data to be recorded later. When recording data on a CD ROM, CD R or CD RW, etc., all data from beginning to end is treated as a single unit or session. Multi session is a method of recording more than two sessions in one disc.

## Multi-subtitle

For example, subtitles in up to 32 languages can be recorded on a single DVD Video, letting you choose as desired.

## Packet write

This is a general term for a method of writing individual files to a CD R, etc. whenever required, just as is done with files on floppy or hard disks.

## Parental lock

Some DVD Video discs with violent or adult oriented scenes feature parental lock which prevents children from viewing such scenes. With this kind of disc, if you set the unit's parental lock level, playback of scenes inappropriate for children will be disabled, or these scenes will be skipped.

## Phone book

An address book on user's phone is collectively referred to as “Phone book”. Depending on the cellular phone, the phone book may be called a name such as “Contacts”, “Business card” or something else.

## Point Of Interest (POI)

Any of a range of locations stored in the data, such as railway stations, shops, restaurants, and amusement parks.



## Appendix

### Region number

DVD players and DVD discs feature region numbers indicating the area in which they were purchased. Playback of a DVD is not possible unless it features the same region number as the DVD player.

### Route setting

The process of determining the ideal route to a specific location; route setting is done automatically by the system when you specify a destination.

### Set route

The route marked out by the system to your destination. It is highlighted in bright color on the map.

### Title

DVD Video discs have a high data capacity, enabling recording of multiple videos on a single disc. If, for example, one disc contains three separate videos, they are divided into title 1, title 2 and title 3. This lets you enjoy the convenience of title search and other functions.

### Track log

Your navigation system logs routes that you already passed through if the track logger is activated. This recorded route is called a "track log". It is handy when you want to check a route traveled or if returning along a complex route.

### VBR

VBR is short for variable bit rate. Generally speaking, CBR (constant bit rate) is more widely used. But by flexibly adjusting the bit rate according to the needs of audio compression, it is possible to produce compression priority data.

### Voice guidance

The giving of directions by navigation voice while in guidance.

### Waypoint

A location that you choose to visit before your destination; a journey can be built up from multiple waypoints and the destination.

### WMA

WMA is short for Windows Media™ Audio and refers to an audio compression technology that is developed by Microsoft Corporation. WMA data can be encoded by using Windows Media Player version 7 or later. 

# Appendix

## Specifications

### General

Rated power source .....	14.4 V DC (allowable voltage range: 10.8V to 15.1 V DC)
Grounding system .....	Negative type
Maximum current consumption .....	10.0 A
Dimensions (W × H × D):	
AVIC Z140BH	
Chassis .....	178 mm × 100 mm × 165 mm (7 in. × 3 7/8 in. × 6 1/2 in.)
Nose .....	170 mm × 96 mm × 20 mm (6 3/4 in. × 3 3/4 in. × 3/4 in.)
AVIC X940BT	
Chassis .....	178 mm × 100 mm × 165 mm (7 in. × 3 7/8 in. × 6 1/2 in.)
Nose .....	170 mm × 96 mm × 12 mm (6 3/4 in. × 3 3/4 in. × 1/2 in.)
Weight:	
AVIC Z140BH .....	2.14 kg (4.7 lbs)
AVIC X940BT .....	1.87 kg (4.1 lbs)
NAND flash memory .....	4 GB

### Navigation

GPS receiver:	
System .....	L1, C/Acode GPS SPS (Standard Positioning Service)
Reception system .....	32 channel multi channel reception system
Reception frequency ...	1 575.42 MHz
Sensitivity .....	140 dBm (typ)
Position update frequency .....	Approx. once per second
GPS antenna:	
Antenna .....	Micro strip flat antenna/ right handed helical polari zation
Antenna cable .....	3.55 m (11 ft. 7 in.)
Dimensions (W × H × D)	
.....	33 mm × 14.7 mm × 36 mm (1 1/4 in. × 4/7 in. × 1 3/8 in.)
Weight .....	73.7 g (0.211 lbs)

### Display

Screen size/aspect ratio:	
AVIC Z140BH .....	7 inch wide/16:9

AVIC X940BT .....	6.1 inch wide/16:9
Effective display area:	
AVIC Z140BH .....	156.6 mm × 81.6 mm
AVIC X940BT .....	136.2 mm × 72 mm
Pixels .....	384 000 (800 × 480)
Display method .....	TFT Active matrix driving
Backlight .....	LED
Color system .....	NTSC compatible
Tolerable temperature range:	
Power on .....	+14 °F to +140 °F
Power off .....	4 °F to +176 °F
Angle adjustment	
AVIC Z140BH .....	0° to 22°
AVIC X940BT .....	0°

### Audio

Maximum power output .....	50 W × 4 50 W × 2 ch/4Ω + 70 W × 1 ch/2Ω (for subwoofer)
Continuous power output .....	22 W × 4 (50 Hz to 15 kHz, 5%THD, 4Ω LOAD, Both Channels Driven)
Load impedance .....	4Ω (4Ω to 8Ω [2Ω for 1 ch] allowable)
Preout output level (max):	
AVIC Z140BH .....	4.0 V
AVIC X940BT .....	2.2 V
Preout impedance:	
AVIC Z140BH .....	100Ω
AVIC X940BT .....	1 kΩ
Equalizer (8 Band Graphic Equalizer):	
Frequency .....	40 Hz/80 Hz/200 Hz/400 Hz/ 1 kHz/2.5 kHz/8 kHz/10 kHz
Gain .....	±12 dB
Loudness contour:	
Low .....	+3.5 dB (100 Hz), +3 dB (10 kHz)
Mid .....	+10 dB (100 Hz), +6.5 dB (10 kHz)
High .....	+11 dB (100 Hz), +11 dB (10 kHz) (volume: 30 dB)
HPF:	
Frequency .....	50 Hz/63 Hz/80 Hz/100 Hz/ 125 Hz
Slope .....	12 dB/oct
Subwoofer:	
Frequency .....	50 Hz/63 Hz/80 Hz/100 Hz/ 125 Hz
Slope .....	18 dB/oct
Gain .....	24/+6 dB
Phase .....	Normal/Reverse
Bass boost:	
Gain .....	0 dB to +12 dB

# Appendix

## DVD Drive

System .....	DVD Video, CD, MP3, WMA, AAC, DivX system
Usable discs .....	DVD Video, DVD R(DL), DVD RW, CD ROM, CD DA, CD R/RW
Region number .....	1
Signal format:	
Sampling frequency .....	44.1 kHz/48 kHz/96 kHz
Number of quantization bits .....	16 bit/20 bit/24 bit; linear
Frequency response .....	5 Hz to 44 000 Hz (with DVD, at sampling frequency 96 kHz)
Signal to noise ratio .....	97 dB (1 kHz) (IHF A network) (CD: 96 dB (1 kHz) (IHF A network))
Dynamic range .....	95 dB (1 kHz) (CD: 94 dB (1 kHz))
Distortion .....	0.008 % (1 kHz)
Output level:	
Video .....	1.0 Vp p/75 $\Omega$ ( $\pm 0.2$ V)
Audio .....	1.0 V (1 kHz, 0 dB)
Number of channels .....	2 (stereo)
MP3 decoding format .....	MPEG 1, 2 & 2.5 Audio Layer 3
WMA decoding format .....	Ver. 7, 8 & 9
AAC decoding format .....	MPEG 4 AAC (only encoded by iTunes): .m4a
DivX decoding format .....	Home Theater Ver.3.11, Ver.4.X, Ver.5.X, Ver.6.X: .avi, .divx

## USB

USB standard spec. ....	USB 2.0 High Speed
Max current supply .....	1 A
File system .....	FAT16, FAT32
USB class .....	Mass storage class
Decoding format .....	MP3/WMA/AAC/WAVE/ H.264/MPEG4/WMV

## SD (AVIC-Z140BH)

SD memory card, SDHC memory card	
Compatible physical format .....	Version 2.00
File system .....	FAT16, FAT32
Decoding format .....	MP3/WMA/AAC/WAVE/ H.264/MPEG4/WMV

## SD (AVIC-X940BT)

microSD card, microSDHC card	
Compatible physical format .....	Version 2.00
File system .....	FAT16, FAT32
Decoding format .....	MP3/WMA/AAC/WAVE/ H.264/MPEG4/WMV

## Bluetooth

Version .....	Bluetooth 2.0+EDR
Output power .....	+4 dBm Max. (Power class 2)

## FM tuner

AVIC Z140BH	
Frequency range .....	87.9 MHz to 107.9 MHz
Usable sensitivity .....	9 dBf (0.8 $\mu$ V/75 $\Omega$ , mono, S/N: 30 dB)
Signal to noise ratio .....	80 dB (digital broadcasting) (IHF A network)
Distortion .....	72 dB (analog broadcasting) (IHF A network)
Distortion .....	0.3 % (at 65 dBf, 1 kHz, stereo)
Distortion .....	0.1 % (at 65 dBf, 1 kHz, mono)
Frequency response .....	30 Hz to 15 000 Hz ( $\pm 3$ dB)
Stereo separation .....	45 dB (at 65 dBf, 1 kHz)
AVIC X940BT	
Frequency range .....	87.9 MHz to 107.9 MHz
Usable sensitivity .....	9 dBf (0.8 $\mu$ V/75 $\Omega$ , mono, S/N: 30 dB)
Signal to noise ratio .....	72 dB (IHF A network)
Distortion .....	0.3 % (at 65 dBf, 1 kHz, stereo)
Distortion .....	0.1 % (at 65 dBf, 1 kHz, mono)
Frequency response .....	30 Hz to 15 000 Hz ( $\pm 3$ dB)
Stereo separation .....	45 dB (at 65 dBf, 1 kHz)

## AM tuner

AVIC Z140BH	
Frequency range .....	530 kHz to 1 710 kHz (10 kHz)
Usable sensitivity .....	25 $\mu$ V (S/N: 20 dB)
Signal to noise ratio .....	80 dB (digital broadcasting) (IHF A network)
Distortion .....	62 dB (analog broadcasting) (IHF A network)
AVIC X940BT	
Frequency range .....	530 kHz to 1 710 kHz (10 kHz)
Usable sensitivity .....	25 $\mu$ V (S/N: 20 dB)
Signal to noise ratio .....	62 dB (IHF A network)

# Appendix

## Traffic tuner (AVIC-Z140BH)

Rated power source .....	13.8 V DC
	(allowable voltage range: 10.0 V to 14.5 V DC)
Grounding system .....	Negative type
Maximum current consumption .....	60 mA
Dimensions (W × H × D) ...	68 mm × 49 mm × 19 mm (2 5/8 in. × 1 7/8 in. × 3/4 in.)
Weight .....	180 g (0.397 lbs)

## CEA2006 Specifications



Power output .....	14 W RMS × 4 Channels (4 Ω and ≤ 1 % THD+N)
S/N ratio .....	91 dBA (reference: 1 W into 4 Ω)



### Note

Specifications and design are subject to possible modifications without notice due to improvements. □

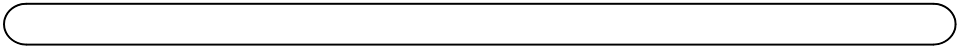

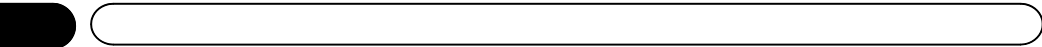



Register your product at

**<http://www.pioneerelectronics.com>**

in Canada **<http://www.pioneerelectronics.ca>**

*See "Visit our website" page*

*To keep up to date with the latest navigational data,  
you can periodically update your navigation system.  
For further details, please visit our website.*

## **PIONEER CORPORATION**

1-1, Shin-ogura, Saiwai-ku, Kawasaki-shi,  
Kanagawa 212-0031, JAPAN

## **PIONEER ELECTRONICS (USA) INC.**

P.O. Box 1540, Long Beach, California 90801-1540, U.S.A.  
TEL: (800) 421-1404

## **PIONEER EUROPE NV**

Haven 1087, Keetberglaan 1, B-9120 Melsele, Belgium/Belgique  
TEL: (0) 3/570.05.11

## **PIONEER ELECTRONICS ASIACENTRE PTE. LTD.**

253 Alexandra Road, #04-01, Singapore 159936  
TEL: 65-6472-7555

## **PIONEER ELECTRONICS AUSTRALIA PTY. LTD.**

5 Arco Lane, Heatherton, Victoria, 3202, Australia  
TEL: (03) 9586-6300

## **PIONEER ELECTRONICS OF CANADA, INC.**

340 Ferrier Street, Unit 2, Markham, Ontario L3R 2Z5, Canada  
TEL: 1-877-283-5901  
TEL: 905-479-4411

## **PIONEER ELECTRONICS DE MEXICO, S.A. de C.V.**

Blvd.Manuel Avila Camacho 138 10 piso  
Col.Lomas de Chapultepec, Mexico, D.F. 11000  
TEL: 55-9178-4270

## **先鋒股份有限公司**

台北市內湖區瑞光路407號8樓  
電話：886-(0)2-2657-3588

## **先鋒電子（香港）有限公司**

香港九龍長沙灣道909號5樓  
電話：852-2848-6488

© 2011 PIONEER CORPORATION.  
All rights reserved.